



Electronic Service Manuals

This electronic document is provided as a service to our customers. We do not create the contents of the information contained in this document. Should you have detailed questions pertaining to the information contained in this document, you may contact Michco, or the manufacturer which provided the original information in this electronic deliverable. Michco's only part in this electronic deliverable was the electronic assembly process. By providing this manual on line we are not guaranteeing parts availability.

You may contact Michco through the following methods:

Phone (517) 484-9312 or (800) 331-3339

2011 N. High St. -- Lansing, Michigan -- 48906

Fax: (517) 484-9836

Email: CustServe@Michco.com

Web site: www.Michco.Com

Parts Web site: www.FloorMachineParts.Com

Order Parts on Line at:

www.FloorMachineParts.Com

Directly to Parts & Service:

By Email: **Shop@Michco.com**

By Fax: (517) 702-2041

By Voice: Use numbers above.

Serving the Cleaning Industry Since 1922

Notice: All copyrighted material remains property of original owners, all trademarks are property of respective owners. Manuals are subject to Manufacturer's reproduction limitations. Originals or reproductions were provided by manufacturers through a request. We make no warranty as to the correctness of information provided in this document and you assume all risk. By placing these manuals on line we are not declaring our corporation to be an manufacturer authorized dealer or provider, please check our web site for authorized manufacturers we represent.



T7

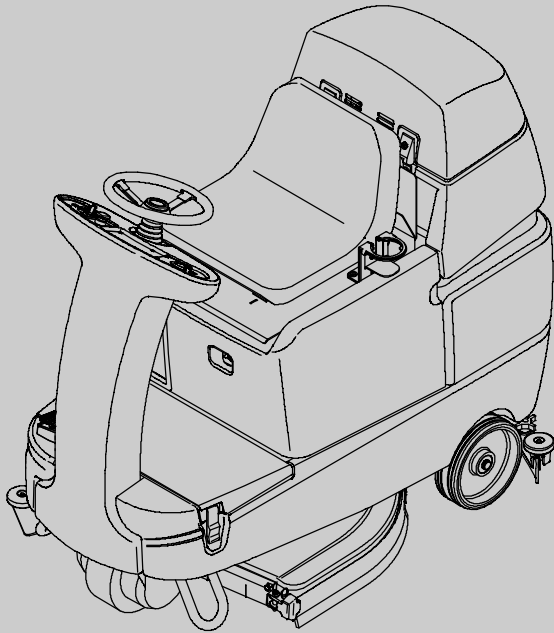

Rider-Scrubber Operator Manual

FaST
Foam Scrubbing Technology[®]
The Safe Scrubbing Alternative[®]

ecH2O[™]
ELECTRICALLY CONVERTED WATER

Hygenic[®] Fully Cleanable Tanks

North America / International

www.tennantco.com

331040
Rev. 04 (02-2009)





This manual is furnished with each new model. It provides necessary operation and maintenance instructions.

Read this manual completely and understand the machine before operating or servicing it.

This machine will provide excellent service. However, the best results will be obtained at minimum costs if:

- The machine is operated with reasonable care.
- The machine is maintained regularly - per the machine maintenance instructions provided.
- The machine is maintained with manufacturer supplied or equivalent parts.

	PROTECT THE ENVIRONMENT Please dispose of packaging materials, old machine components such as batteries, hazardous fluids such as antifreeze and oil, in an environmentally safe way according to local waste disposal regulations.
	Always remember to recycle.

MACHINE DATA	
Please fill out at time of installation for future reference.	
Model No. -	_____
Serial No. -	_____
Machine Options -	_____
Sales Rep. -	_____
Sales Rep. phone no. -	_____
Customer Number -	_____
Installation Date -	_____

Tennant Company
PO Box 1452
Minneapolis, MN 55440
Phone: (800) 553-8033 or (763) 513-2850
www.tennantco.com

FaST-PAK is a US registered and unregistered trademark of Tennant Company.

Specifications and parts are subject to change without notice.

Copyright © 2004-2009 TENNANT Company, Printed in U.S.A.

CONTENTS

	Page		Page
SAFETY PRECAUTIONS	2	ON-BOARD BATTERY CHARGER	
OPERATION	4	ERROR CODES	29
MACHINE COMPONENTS	4	ELECTRIC MOTORS	30
CONTROLS AND INSTRUMENTS	5	BELTS (Cylindrical Models)	30
HOW THE MACHINE WORKS	6	SCRUB BRUSHES AND PADS	31
CONVENTIONAL SCRUBBING	6	DISK BRUSHES	31
FOAM SCRUBBING SYSTEM		REPLACING DISK BRUSHES OR PAD	
(FaST Model)	6	DRIVER	31
ec-H2O SCRUBBING (ec-H2O Model)	7	REPLACING DISK PADS	32
BRUSH INFORMATION	7	CYLINDRICAL BRUSHES	33
MACHINE SETUP	8	REPLACING OR ROTATING	
ATTACHING SQUEEGEE ASSEMBLY	8	CYLINDRICAL BRUSHES	33
INSTALLING BRUSHES/PADS	8	CHECKING CYLINDRICAL BRUSH	
INSTALLING THE FaST-PAK		PATTERN	34
(FaST Model)	8	ADJUSTING CYLINDRICAL BRUSH	
FILLING THE SOLUTION TANK	9	TAPER	35
MACHINE OPERATION	9	ADJUSTING CYLINDRICAL BRUSH	
PRE-OPERATION CHECKLIST	9	WIDTH	36
BEFORE OPERATING	9	FaST SYSTEM MAINTENANCE	
SETTING SCRUB MODES	10	(FaST Model)	36
SETTING FaST BUTTON	10	FaST SUPPLY HOSE CONNECTOR .	37
SETTING ec-H2O BUTTON	10	ec-H2O SYSTEM (ec-H2O Model)	37
SETTING BRUSH PRESSURE	10	ec-H2O MODULE FLUSH	
SETTING SOLUTION FLOW		PROCEDURE	37
(CONVENTIONAL SCRUBBING		SQUEEGEE BLADES	38
ONLY)	10	REPLACING (OR ROTATING) THE REAR	
ECONOMY SETTING	11	SQUEEGEE BLADES	38
SCRUBBING	11	REPLACING SIDE SQUEEGEE	
DOUBLE SCRUBBING	13	BLADES	40
WATER PICKUP MODE		ADJUSTING THE SQUEEGEE GUIDE	
(NO SCRUBBING)	14	ROLLER	40
WHILE OPERATING THE MACHINE .	14	LEVELING THE REAR SQUEEGEE ..	40
EMERGENCY STOP BUTTON	15	ADJUSTING REAR SQUEEGEE BLADE	
HOUR METER	15	DEFLECTION	41
ec-H2O SYSTEM INDICATOR LIGHT	15	SKIRTS AND SEALS	42
SOLUTION TANK EMPTY INDICATOR	15	DISK SCRUB HEAD FLOOR SKIRT ..	42
RECOVERY TANK FULL INDICATOR .	15	RECOVERY TANK SEAL	42
BATTERY DISCHARGE INDICATOR .	16	SOLUTION TANK SEALS	42
FAULT INDICATOR	17	TIRES	42
CIRCUIT BREAKERS	18	PUSHING, TOWING, AND TRANSPORTING	
FUSES	18	THE MACHINE	43
HAZARD LIGHT SWITCH (OPTION) ..	18	PUSHING OR TOWING THE MACHINE	43
DRAINING AND CLEANING THE TANKS	19	TRANSPORTING THE MACHINE	43
PROPEL SYSTEM TROUBLESHOOTING	21	MACHINE JACKING	44
MACHINE TROUBLESHOOTING	22	STORAGE INFORMATION	44
MAINTENANCE	24	FREEZE PROTECTION	44
MAINTENANCE CHART	25	SPECIFICATIONS	46
BATTERIES	26	GENERAL MACHINE	
GEL BATTERIES	26	DIMENSIONS/CAPACITIES	46
LEAD ACID BATTERIES	26	GENERAL MACHINE PERFORMANCE	46
CHARGING THE BATTERIES WITH		POWER TYPE	47
OFF-BOARD CHARGER	27	TIRES	47
CHECKING ON-BOARD BATTERY		FaST SYSTEM (OPTION)	47
CHARGER SETTINGS	28	ec-H2O SYSTEM (OPTION)	47
CHARGING THE BATTERIES WITH THE		MACHINE DIMENSIONS	48
ON-BOARD CHARGER	29	INDEX	49

SAFETY PRECAUTIONS

The following symbols are used throughout this manual as indicated in the descriptions:



WARNING: To warn of hazards or unsafe practices that could result in severe personal injury or death.

FOR SAFETY: To identify actions that must be followed for safe operation of equipment.

This machine is designed solely for cleaning smooth flooring in an indoor environment. Tennant does not recommend using this machine in any other environment.

The following information signals potentially dangerous conditions to the operator or equipment. Read this manual carefully. Know when these conditions can exist. Locate all safety devices on the machine. Then, take necessary steps to train machine operating personnel. Report machine damage or faulty operation immediately. Do not use the machine if it is not in proper operating condition.



WARNING: Batteries emit hydrogen gas. Explosion or fire can result. Keep sparks and open flame away. Keep covers open when charging.



WARNING: Flammable materials can cause an explosion or fire. Do not use flammable materials in tank(s).



WARNING: Flammable materials or reactive metals can cause an explosion or fire. Do not pick up.

FOR SAFETY:

1. Do not operate machine:
 - Unless trained and authorized.
 - With brake disabled.
 - Unless operation manual is read and understood.
 - In flammable or explosive areas.
 - In areas with possible falling objects.
2. Before starting machine:
 - Make sure all safety devices are in place and operate properly.
 - Check brakes and steering for proper operation.

3. When using machine:
 - Go slow on inclines and slippery surfaces.
 - Use care when backing machine.
 - Report machine damage or faulty operation immediately.
 - Follow mixing and handling instructions on chemical containers.
4. Before leaving or servicing machine:
 - Stop on level surface.
 - Turn off machine and remove key.
5. When servicing machine:
 - Do not push or tow the machine on inclines with the brake disabled.
 - Avoid moving parts. Do not wear loose jackets, shirts, or sleeves when working on machine.
 - Block machine tires before jacking machine up.
 - Jack machine up at designated locations only. Block machine up with jack stands.
 - Use hoist or jack that will support the weight of the machine.
 - Wear eye and ear protection when using pressurized air or water.
 - Wear protective gloves when handling batteries or battery cables.
 - Disconnect battery connections before working on machine.
 - Avoid contact with battery acid.
 - Wear protective gloves and eye protection when handling vinegar.
 - Do not power spray or hose off machine. Electrical malfunction may occur.
 - Use Tennant supplied or equivalent replacement parts.
6. When loading/unloading machine onto/off truck or trailer:
 - Drain tanks before loading machine.
 - Turn off machine.
 - Use truck or trailer that will support the weight of the machine.
 - Block machine tires.
 - Lower scrub head and squeegee before tying down machine.
 - Tie machine down to truck or trailer.
 - Use a ramp that can support the machine weight and operator.
 - Do not operate the machine on a ramp incline that exceeds an 11 degree angle

The safety labels appear on the machine in the locations indicated. If these or any label becomes damaged or illegible, install a new label in its place.

BATTERY CHARGING LABEL - LOCATED ON THE SEAT PANEL



FLAMMABLE SPILLS LABEL - LOCATED ON THE SEAT PANEL



FOR SAFETY LABEL - LOCATED ON THE SEAT PANEL

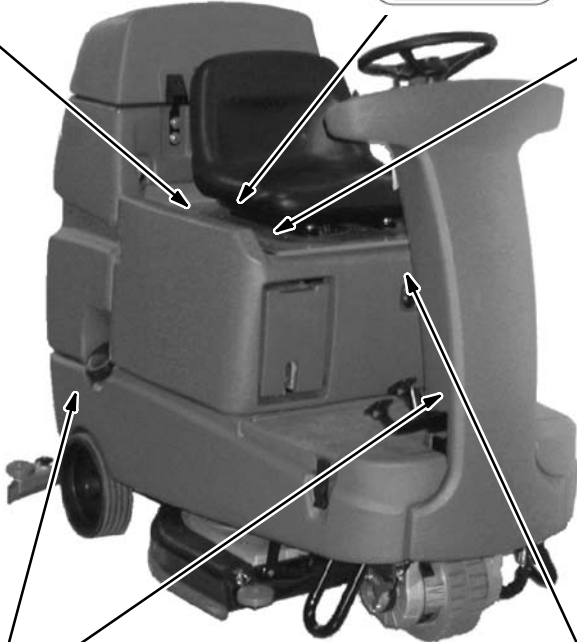

FLAMMABLE MATERIALS LABEL - LOCATED UNDER THE SOLUTION FILL PORT AND NEXT TO FOOT PEDALS



ELECTRICAL COMPONENTS, USE GROUNDING STRAP BEFORE OPENING PANEL LABEL - LOCATED ON ELECTRICAL PANEL UNDER THE SEAT

MACHINE COMPONENTS

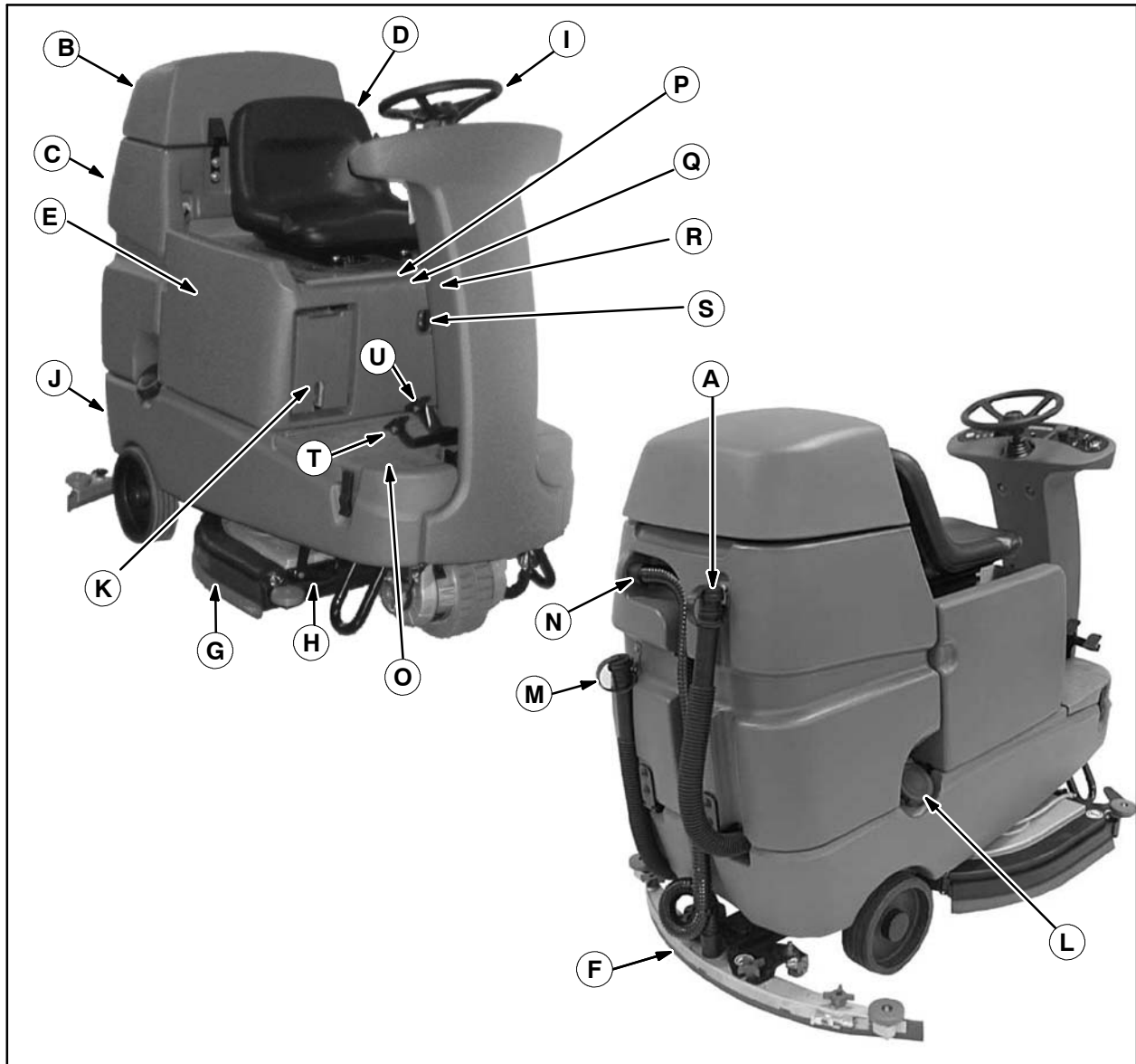

- A. Recovery tank drain hose
- B. Recovery tank cover
- C. Recovery tank
- D. Operator seat
- E. Batteries
- F. Rear squeegee
- G. Side squeegee
- H. Scrub head
- I. Steering wheel
- J. Solution tank
- K. Tool Box or optional FaST-PAK compartment
ec-H2O System Module (option)
- L. Solution tank fill cap

- M. Solution tank drain hose
- N. Squeegee hose
- O. Front solution tank cover
- P. Hour meter
- Q. Circuit breakers
- R. 100 A Fuse
- S. Battery charging connector
- T. Propel pedal
- U. Brake pedal

CONTROLS AND INSTRUMENTS

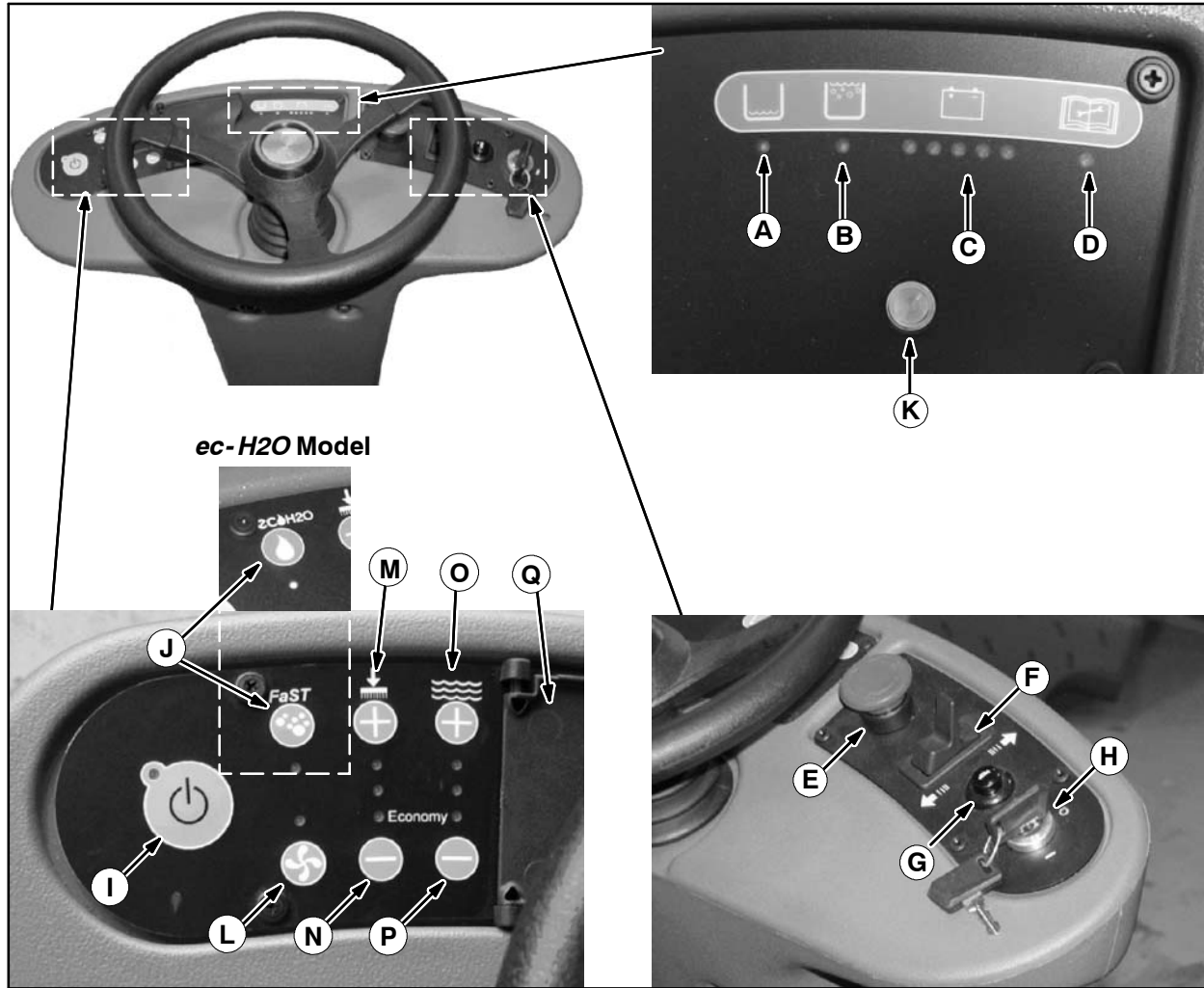

- A. Solution tank empty indicator
- B. Recovery tank full indicator
- C. Battery charge level indicators
- D. Fault indicator
- E. Emergency Stop Button
- F. Directional switch
- G. Horn button
- H. On/Off key switch
- I. One Step scrub button
- J. FaST button (option)
ec-H2O system on/off switch (option)
- K. *ec-H2O* system indicator light (option)
- L. Vacuum fan / squeegee button
- M. Brush Pressure increase button (+)
- N. Brush Pressure decrease button (-)
- O. Solution increase button (+)
- P. Solution decrease button (-)
- Q. Control panel cover

OPERATION

HOW THE MACHINE WORKS

The scrub components of the machine are a solution tank, scrub brushes or pads, a squeegee, a vacuum fan, and a recovery tank.

The buttons on the control panel control the machine scrubbing functions. The *One Step Scrub button* turns the preset scrub functions on and off. The *FaST button* (option) enables the FaST (Foam Scrubbing Technology) system. The *ec-H₂O button* (option) enables the *ec-H₂O* (electrically converted water) system. The *vacuum fan / squeegee button* turns the vacuum fan on/off and raises and lowers the squeegee. The *brush pressure buttons* control the scrub brush pressure, and the *solution buttons* control the solution flow.

The *steering wheel* controls the path of the machine travel. The *directional switch* controls the forward or reverse direction of the machine. The *propel pedal* controls the speed of the machine. The *brake pedal* slows and stops the machine.

There are two different types of scrub heads available, cylindrical and disk. Both scrub heads are available in two different widths. The Disk scrub head is available in 650 mm (26 in) wide and 800 mm (32 in) wide. The Cylindrical scrub head is available in 700 mm (28 in) wide and 800 mm (32 in) wide.

NOTE: The amount and type of soilage play an important role in determining the type of brushes or pads to use. For specific recommendations, see the BRUSH INFORMATION section of this manual or contact a Tennant representative.

CONVENTIONAL SCRUBBING

Water and detergent from the solution tank flow to the floor through a solution valve. The brushes use the detergent and water solution to scrub the floor clean. As the machine propels forward, the squeegee wipes the dirty solution from the floor. The suction created by the vacuum fan then draws the dirty solution from the squeegee into the recovery tank.

FOAM SCRUBBING SYSTEM (FaST MODEL)

Unlike conventional scrubbing, the optional FaST (Foam Scrubbing Technology) system operates by injecting the FaST-PAK concentrate agent into the system with a small amount of water and air. This mixture creates a large volume of expanded wet foam.

The expanded foam mixture is then dispersed onto the floor while the machine is scrubbing. When the squeegee picks up the mixture, the patented foaming agent has collapsed and is recovered into the recovery tank.



The Safe Scrubbing Alternative®

The FaST system can be used with all double scrubbing and heavy duty scrubbing applications.

Using the FaST system improves safety and can increase productivity by 30% by reducing your dump/fill cycle. It will also reduce chemical usage and storage space. One FaST-PAK of concentrated agent can scrub up to 90,000 m² (1 million square feet).

NOTE: Do not use the FaST system with conventional cleaning detergents in the solution tank. Drain, rinse and refill the solution tank with clear cool water before operating the FaST system. Conventional cleaning detergents may cause failure to the FaST system.

ec-H2O SCRUBBING (ec-H2O Model)

The *ec-H2O* (electrically converted water) system operates by producing electrically converted water for cleaning.

Normal water passes through a module where it is oxygenated and charged with an electric current. The electrically converted water changes into a blended acidic and alkaline solution forming a neutral pH cleaner. The converted water attacks the dirt, breaks it into smaller particles, and pulls it off the floor surface allowing the machine to easily scrub away the suspended soil. The converted water then returns to normal water in the recovery tank.

The *ec-H2O* system can be used with all double scrubbing applications.

NOTE: Do not enable the ec-H2O system with conventional cleaning detergents in the solution tank. Drain, raise and refill the solution tank with clear cool water only before operating the ec-H2O system. Conventional cleaning detergents/ restorers may cause failure to the ec-H2O solution system.

NOTE: Storage or transporting machines equipped with ec-H2O in freezing temperatures requires special procedures. Follow the freeze protection procedure located in the STORAGE INFORMATION section.

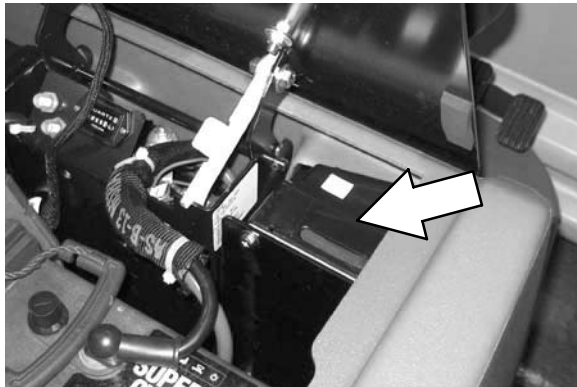

ecH2O™
ELECTRICALLY CONVERTED WATER

BRUSH INFORMATION

For best results, use the correct brush type for the cleaning application. The following are recommended brush applications.

Non-scuff polypropylene brush (Cylindrical and Disk) – This brush uses a softer, general purpose polypropylene bristle to lift lightly compacted soilage without scuffing high-gloss coated floors.

Nylon brush (Cylindrical and Disk) – Softer nylon bristles are recommended for scrubbing coated floors. Cleans without scuffing

Super abrasive bristle brush (Cylindrical and Disk) – Nylon fiber impregnated with abrasive grit to remove stains and soilage. Strong action on any surface. Performs well on buildup, grease, or tire marks.

Surface preparation pad – This maroon pad is for very aggressive floor stripping.

Heavy duty stripping pad – This black pad is for stripping floors. Cuts through old heavy finishes easier to prepare the floor for recoating.

Stripping pad – This brown pad is for stripping floors. Quickly and easily cuts through old finish to prepare the floor for recoating.

Scrubbing pad – This blue pad is for scrubbing floors. Removes dirt, spills, and scuffs. Leaves a clean surface ready for recoating.

Buffing pad – This red pad is for buffing floors. Quickly cleans and removes scuff marks while polishing the floor to a high gloss.

Polishing pad – This white pad is for polishing floors. Maintains a high gloss. Use for buffing very soft finishes and lower traffic areas, and polishing soft waxes on wood floors.

OPERATION

MACHINE SETUP

ATTACHING SQUEEGEE ASSEMBLY

1. Stop machine on a level surface.
2. Turn the machine *ON/OFF* key switch off.

FOR SAFETY: Before leaving or servicing machine, stop on level surface, and turn off machine.

3. Place the rear squeegee under the squeegee mount bracket and fasten with the two knobs.
4. Connect the vacuum hose to the squeegee assembly. Loop the hose as shown using the hose clip provided.

The squeegee deflection is set at the factory. If the squeegee blade needs adjustments, see **ADJUSTING REAR SQUEEGEE BLADE DEFLECTION** section of this manual.

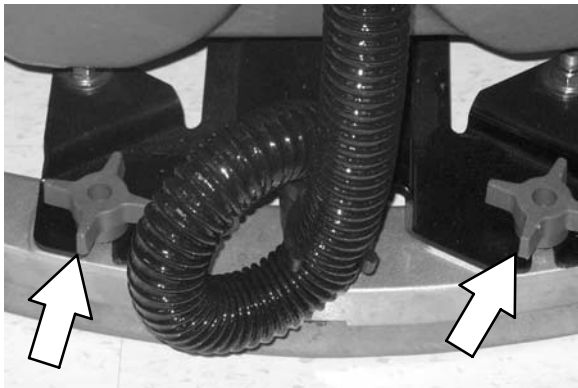

INSTALLING BRUSHES/PADS

To install the brushes or pad, see *REPLACING DISK SCRUB BRUSHES OR PAD DRIVER* or *REPLACING CYLINDRICAL SCRUB BRUSHES* section of this manual.

INSTALLING THE FaST-PAK (FaST Model)

1. Stop machine on a level surface.
2. Turn off the machine *ON/OFF* key switch.

FOR SAFETY: Before leaving or servicing machine, stop on level surface, and turn off machine.

3. Open the FaST-PAK compartment door and slide the empty FaST-PAK approximately half way out from the FaST-PAK compartment door.



4. Squeeze the button on the FaST supply hose connector, then pull the empty FaST-PAK out from the compartment.



5. Remove the perforated knock outs from the new FaST-PAK carton. Do Not remove the bag from the carton. Pull out the hose connector located on the bottom of the bag and remove the hose cap from the connector.

NOTE: The FaST-PAK Floor Cleaning Concentrate is specially designed for use with the FaST system scrubbing application. NEVER use a substitute. Other cleaning solutions may cause FaST system failure.

6. Insert the new FaST-PAK approximately half way into the FaST-PAK compartment.
7. Connect the FaST-PAK hose connector to the FaST supply hose connector, slide the FaST-PAK the rest of the way into the FaST-PAK compartment, and close the FaST-PAK compartment door.
8. When replacing an empty FaST-PAK carton, you must scrub with the FaST system for a few minutes before the detergent will reach its maximum foaming.

FILLING THE SOLUTION TANK

The machine is equipped with a fill port at the rear of the machine.

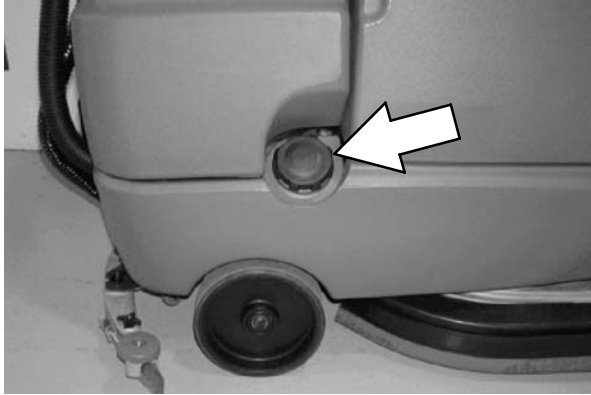

WARNING: Flammable materials can cause an explosion or fire. Do not use flammable materials in tank(s).

FOR CONVENTIONAL SCRUBBING: Open the solution tank fill port and partially fill it with water (not to exceed 60°C / 140°F). Pour the required amount of detergent into the solution tank according to mixing instructions on the bottle. Then continue filling the solution tank with warm water until the water level is just below the fill port.

FOR SAFETY: When using machine, follow mixing and handling instructions on chemical containers.

FOR FaST or *ec-H2O* SCRUBBING: Use cool clean water only (less than 21°C / 70°F). Do not add any conventional floor cleaning detergents, system failure may result.

NOTE: When filling the solution tank with a bucket, make sure that the bucket is clean. Do not use the same bucket for filling and draining the machine.

ATTENTION: For Conventional Scrubbing, only use recommended cleaning detergents. Machine damage due to improper detergent usage will void the manufacturer's warranty.

MACHINE OPERATION

PRE-OPERATION CHECKLIST

- Check the battery fluid and charge level.
- Check the tank cover seals for damage and wear.
- Clean the vacuum fan inlet filter.
- Check the condition of the scrubbing brushes. Remove any string, banding, plastic wrap, or other debris wrapped around them.
- Cylindrical brushes: Check that the debris tray is empty and clean.
- Check the squeegees for damage, wear and for deflection adjustment.
- Check the vacuum hose for debris or blockage.
- Drain and clean the recovery tank.
- Check the brakes and steering for proper operation.
- Check the service records to determine maintenance requirements.
- FaST Scrubbing:** Check the FaST-PAK (option) concentrate agent level. Replace carton as needed. See the INSTALLING THE FaST-PAK AGENT section of the manual.
- For FaST or *ec-H2O* Scrubbing:** Ensure that all conventional cleaning agents are drained and rinsed from the solution tank.
- For FaST or *ec-H2O* Scrubbing:** Ensure that the solution tank is filled with **clear cool water only**.

BEFORE OPERATING

Pick up oversized debris before scrubbing. Pick up pieces of wire, string, twine, etc., that could become wrapped around the scrub brush.

Plan the scrubbing in advance. Try to arrange long runs with minimum stopping and starting. Do an entire floor or section at one time.

Pre-sweep the area to prevent streaking.

OPERATION

SETTING SCRUB MODES

Before scrubbing, select the type of scrubbing will be used, FaST (option), *ec-H2O* (option) or conventional scrubbing. Then set the preferred brush pressure and solution flow settings.

SETTING FaST BUTTON

The FaST button enables the FaST system to come on when the One Step Scrub button is on. The light next to the button will come on when it is in this mode.

NOTE: The solution flow cannot be adjusted when the machine is in the FaST mode.

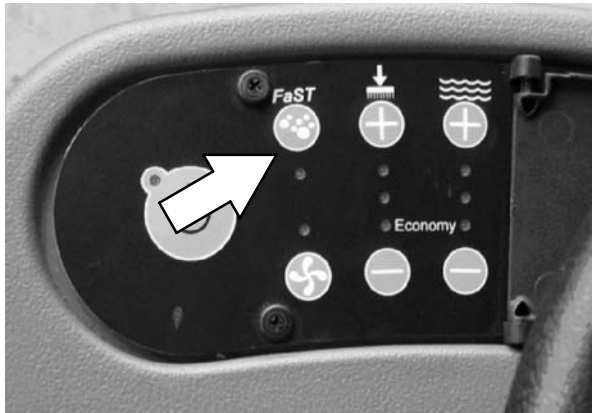

SETTING BRUSH PRESSURE

Under normal conditions, the brush pressure should be set to the minimum setting (the bottom light). Under heavy grime conditions, the brush pressure should be set to the maximum setting (the top light). Travel speed and floor conditions will affect scrubbing performance.

With the *One Step Scrub* button on, press either the *Brush Pressure increase* button (+) or the *Brush Pressure decrease* button (-) to set the scrubbing pressure for the surface being cleaned. The new pressure setting will default to this setting when the machine is powered on or off.

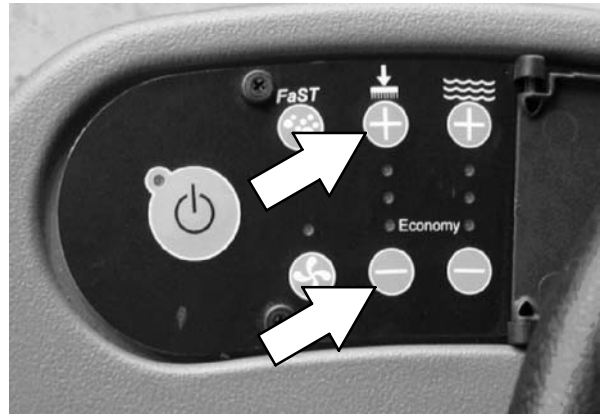

SETTING *ec-H2O* BUTTON

The *ec-H2O* button enables the *ec-H2O* system to come on when the One Step Scrub button is on. The light next to the button will come on when it is in this mode.

*NOTE: The *ec-H2O* system indicator light will not turn on until the machine starts scrubbing (See page 15).*

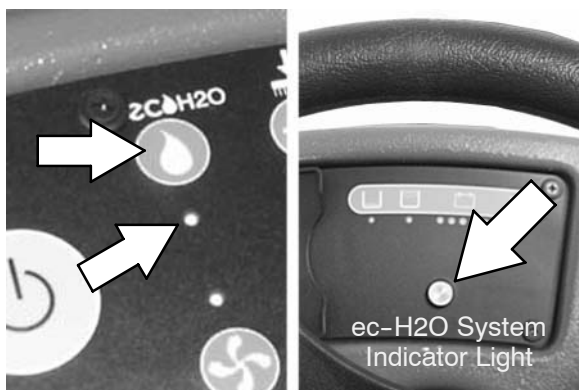

SETTING SOLUTION FLOW (CONVENTIONAL SCRUBBING ONLY)

*NOTE: The solution flow cannot be adjusted when the machine is set for FaST or *ec-H2O* scrubbing.*

Under normal soilage conditions the solution flow level should be set to the lowest setting (the bottom light). Under heavy grime conditions, the solution flow level should be set to the higher settings (middle or top lights). Travel speed and floor conditions will affect scrubbing performance.

With the *One Step Scrub* button on, press either *Solution increase* button (+) or *Solution decrease* button (-) to set the solution flow level for the surface being cleaned. The new solution flow setting will default to this setting when the machine is powered on or off.

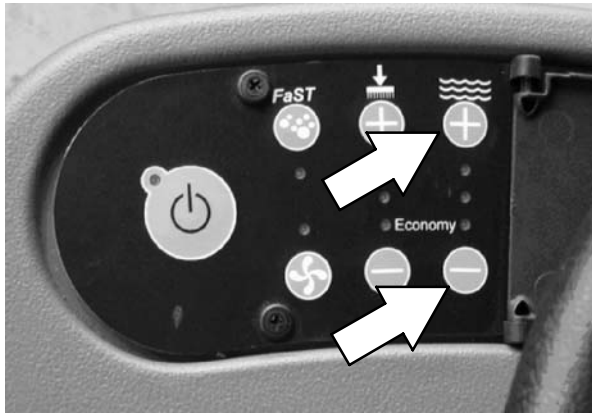

ECONOMY SETTING

The machine will operate for a longer time if the *Brush Pressure* and *Solution Flow* settings are in the *Economy* setting. The bottom lights of the *Brush Pressure* and *Solution Flow* settings are on when the machine is in the *Economy* setting.

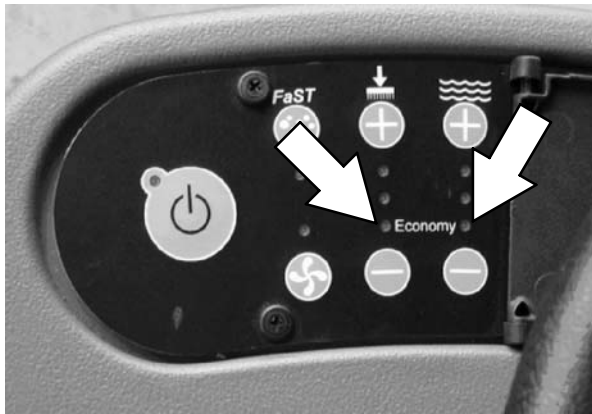

SCRUBBING

FOR SAFETY: Do not operate machine, unless operator manual is read and understood.

1. Turn the *On/Off* key switch on.
2. Select the preferred scrubbing settings (See SETTING SCRUB MODES).

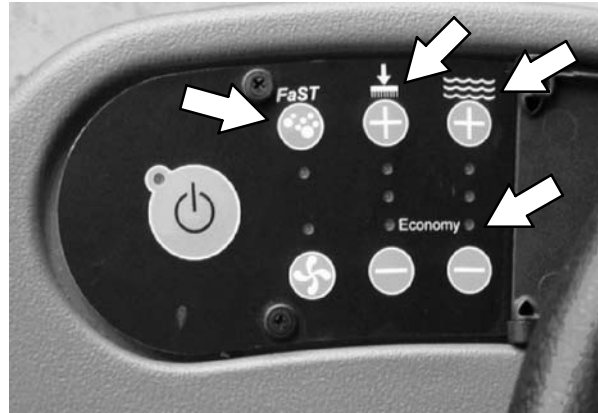

3. Press the *One Step Scrub* button. The light on the button is illuminated. All the preset scrubbing functions will turn on.

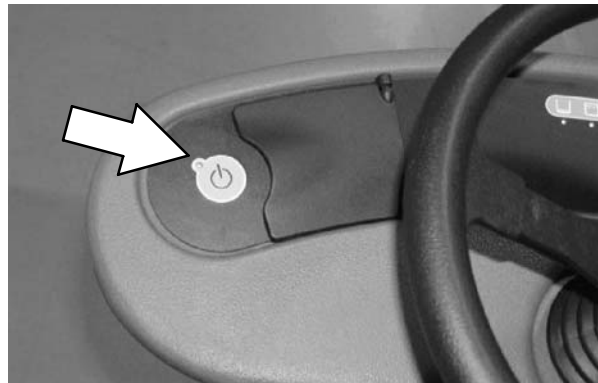

NOTE: Open the control panel cover to adjust the *Brush Pressure* and *Solution Flow* Setting while scrubbing if necessary.

NOTE: DO NOT turn the *ec-H2O/FaST* system on during conventional scrubbing. Conventional cleaning detergents/restorers may cause failure to the *FaST/ec-H2O* solution system. Drain, rinse and refill solution tank with cool clean water before operating the *FaST/ec-H2O* system.

4. Place the *directional* switch in the direction the machine is to be moved (forward or reverse).

NOTE: The machine can scrub in both forward or reverse. The horn will sound when in reverse.

OPERATION

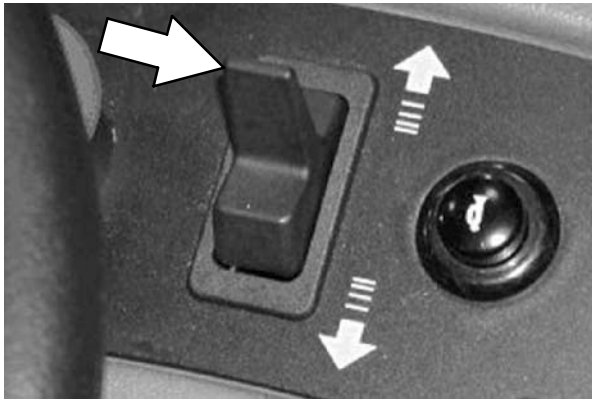

NOTE: The squeegee automatically raises when the machine is driven backwards. This prevents damaging the squeegee. When the machine is placed in reverse, the vacuum fan will shut off after a short delay.

5. Press the *propel pedal* to begin scrubbing.



WARNING: Flammable materials or reactive metals can cause an explosion or fire. Do not pick up.

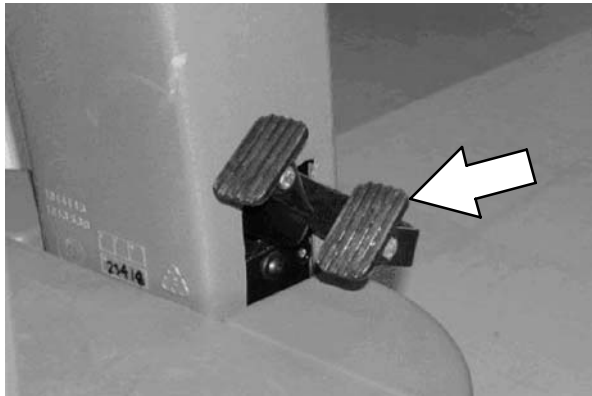

6. Release the *propel pedal* to stop the machine. Scrubbing functions stop and the automatic *park brake* will engage when the machine stops.
7. The *Brake pedal* can be used to control the machine if quicker stopping is needed or if operating on an incline. Do not operate machine on inclines exceeding 7% (4°) when scrubbing.

FOR SAFETY: When using machine, go slow on inclines and slippery surfaces.

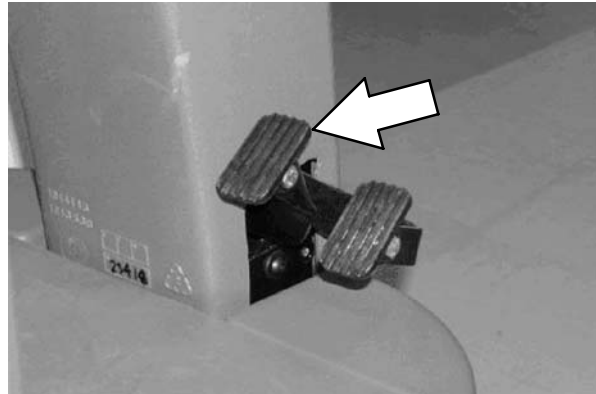

8. Press the *One Step Scrub button* to stop scrubbing. The light next to the *One Step Scrub button* will turn off and the scrubbing functions will turn off after a short delay.

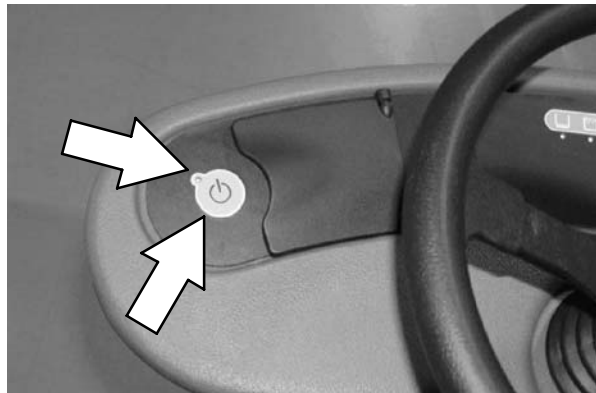

DOUBLE SCRUBBING

For heavily soiled areas, use the double scrubbing method.

Double scrubbing can be performed using the FaST SCRUBBING SYSTEM (option), ec-H₂O SCRUBBING SYSTEM (option) or CONVENTIONAL SCRUBBING methods.

Disk brushes: Before double scrubbing, remove the side squeegees to keep them from channeling water while double scrubbing. To remove the side squeegees, lower the scrub head, then pull the pins on the front and rear ends of the squeegees. If the machine is equipped with the accessory basket, you may hang the side squeegees from the hooks.

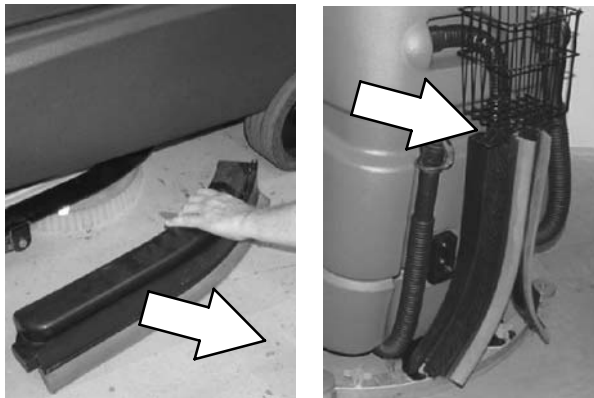

Place the side squeegees back on to the machine before scrubbing the floor the second time.

NOTE: It is easier to put the side squeegees back on to the machine with the scrub head partially lowered. This allows clearance to install the pins.

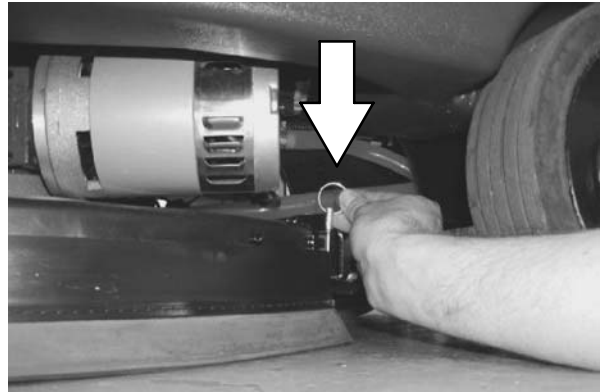

Press the *vacuum fan button* again to lower the squeegee and to turn on the vacuum fan. The light above the *vacuum fan button* will come on. Then scrub the floor a second time picking up the cleaning solution.

⚠ WARNING: Flammable materials or reactive metals can cause an explosion or fire. Do not pick up.

To double scrub, press the *One Step Scrub button*, then the *vacuum fan button*. The light above the *vacuum fan button* will turn off, the squeegee will raise and the vacuum fan will stop operating. Then scrub the area.

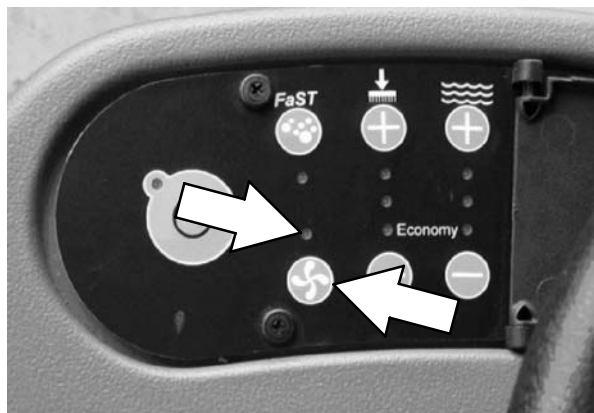

Let the cleaning solution set on the floor for 3-5 minutes.

OPERATION

WATER PICKUP MODE (NO SCRUBBING)

The machine can be used to pick up water or non-flammable liquid spills without scrubbing.

To pick up water or non-flammable liquid spills, check to make sure that the *One Step Scrub button* is not activated. The light next to the *One Step Scrub button* must be off.

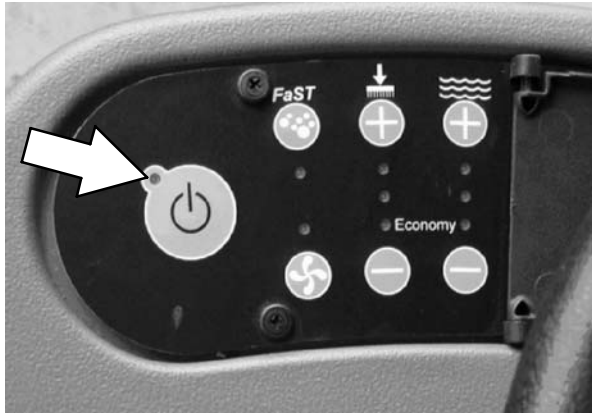

WARNING: Flammable materials or reactive metals can cause an explosion or fire. Do not pick up.

Then press the *vacuum fan button*. The light above the *vacuum fan button* will turn on, the squeegee will lower and the vacuum fan will start operating. Then pick up the water or non-flammable liquid spill.

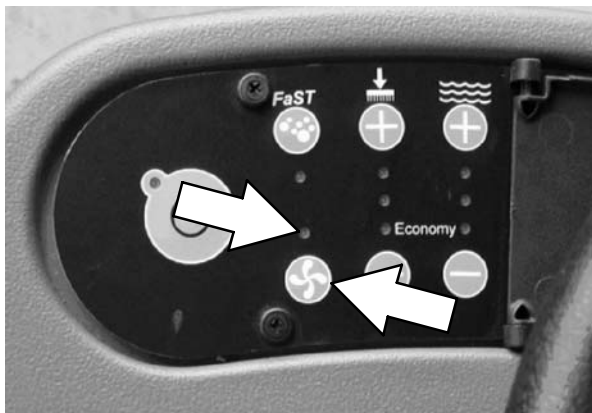

WHILE OPERATING THE MACHINE

Drive as straight a path as possible. Avoid bumping into posts or scraping the sides of the machine. Overlap the scrub paths by several centimeters (a few inches).

Avoid turning the steering wheel too sharply when the machine is in motion. The machine is very responsive to the movement of the steering wheel. Avoid sudden turns, except in emergencies.

When scrubbing dead end aisles, start at the closed end of the aisle and scrub out towards the opening.

Adjust the machine speed, brush pressure, and solution flow as required when scrubbing. Use the minimal brush pressure and solution flow settings as possible.

Keep the machine moving to prevent damaging floor finishes.

If poor scrubbing performance is observed, stop scrubbing and refer to *MACHINE TROUBLESHOOTING*.

Conventional Scrubbing: Pour a recommended foam control solution into the recovery tank if excessive foam appears.

ec-H2O SCRUBBING: If an alarm sounds and the *ec-H2O* system indicator light begins to blink red, the *ec-H2O* module must be flushed to resume *ec-H2O* operation (See *ec-H2O* MODULE FLUSH PROCEDURE on page 37)

NOTE: When the alarm sounds and the light blinks red, the machine will bypass the ec-H2O system. To continue scrubbing, turn the ec-H2O switch off and change over to conventional scrubbing.

Change or rotate pads as necessary.

Observe the battery discharge indicator to ensure there is adequate charge for machine operation.

Observe the solution tank indicator to ensure the solution tank is not empty. Always empty recovery tank before refilling the solution tank.

Observe the recovery tank indicator to ensure the recovery is not full.

Remove the key when leaving the machine unattended.

Perform the Daily Maintenance Procedures after scrubbing (see *MACHINE MAINTENANCE*).

EMERGENCY STOP BUTTON

The *Emergency Stop Button* halts all power to the machine in case of an emergency. Press the button to halt the machine power. To restart the machine, turn the *Emergency Stop Button* to the right. Then turn the on/off switch to the off position and then to the on position.

NOTE: This button should not be used for normal stopping as premature wear to the parking brake may occur.

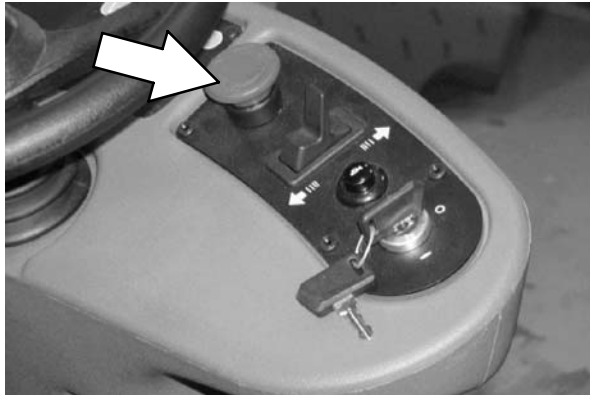

HOUR METER

The *hour meter* records the number of hours the machine has been powered on. This information is useful for servicing the machine. It is located under the seat.

ec-H2O SYSTEM INDICATOR LIGHT

The *ec-H2O system indicator light* will not turn on until the machine starts scrubbing.

ec-H2O SYSTEM INDICATOR LIGHT CODE	CONDITION
Solid green	Normal operation
Blinking red	Flush <i>ec-H2O</i> module
Solid red	Contact Service Center



ec-H2O SCRUBBING: If an alarm sounds and the *ec-H2O* system indicator light begins to blink red, the *ec-H2O* module must be flushed to resume *ec-H2O* operation (See *ec-H2O* MODULE FLUSH PROCEDURE on page 37)

*NOTE: When the alarm sounds and the light blinks red, the machine will bypass the *ec-H2O* system. To continue scrubbing, turn the *ec-H2O* switch off and change over to conventional scrubbing.*

SOLUTION TANK EMPTY INDICATOR

The *solution tank empty indicator* comes on when the solution tank is empty. When this happens, the scrub functions are disabled. If necessary, press the *ONE STEP Scrub button* for an additional minute of operation to pick up standing water or solution.

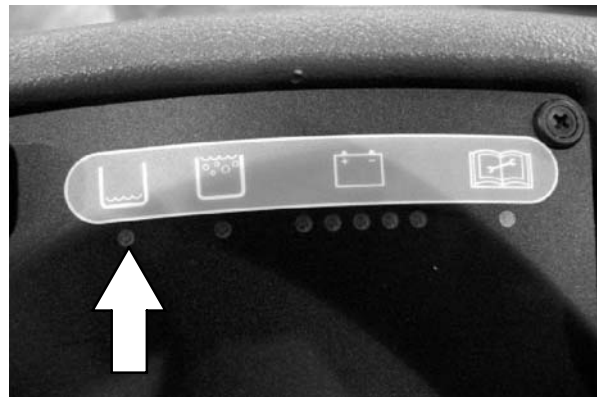

RECOVERY TANK FULL INDICATOR

The *recovery tank full indicator* comes on when the recovery tank is full. When this happens, the scrub functions are disabled. If necessary, press the *ONE STEP Scrub button* for an additional minute of operation to pick up standing water or solution.

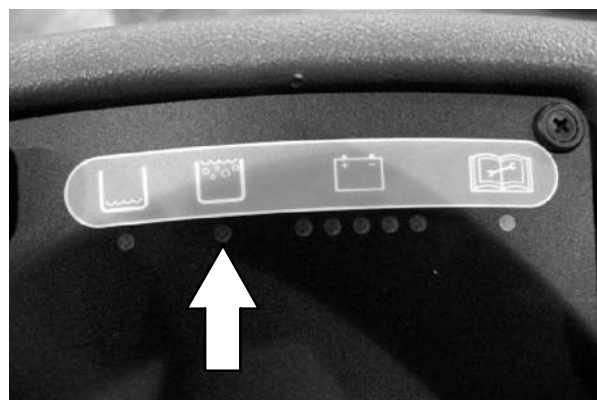

OPERATION

BATTERY DISCHARGE INDICATOR

The *battery discharge indicator* shows the charge level of the batteries.

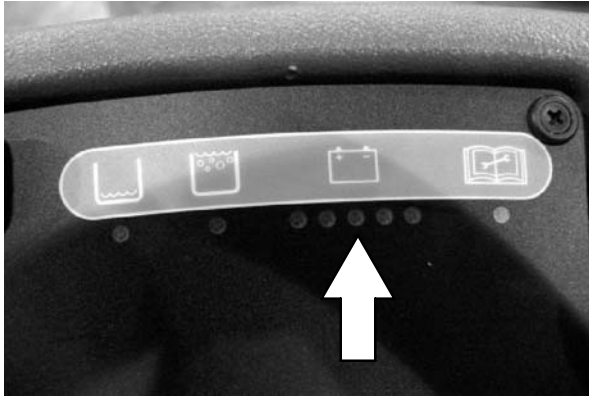

When the batteries are fully charged, all five lights are lit. As the batteries discharge, the lights go out until only the left light is blinking.

When the left light blinks, the scrubbing functions will shut off to alert the operator of the battery condition. The machine will still propel when the light is blinking. Recharge the batteries when the light blinks. If necessary, press the *ONE STEP Scrub button* for an additional minute of operation to pick up standing water or solution.

NOTE: Do not charge batteries more often than necessary. Excessive charging could reduce the life of the batteries. It is best to charge the batteries only when the left light indicates that the battery needs charging. See BATTERIES in the MAINTENANCE section.

NOTE: The blinking left battery discharge light will not reset from blinking until the batteries are fully charged.

FAULT INDICATOR

The *fault indicator* light (shown in upper right) comes on when there a fault is detected in the propelling motor, vacuum fan motor, or brush motors.

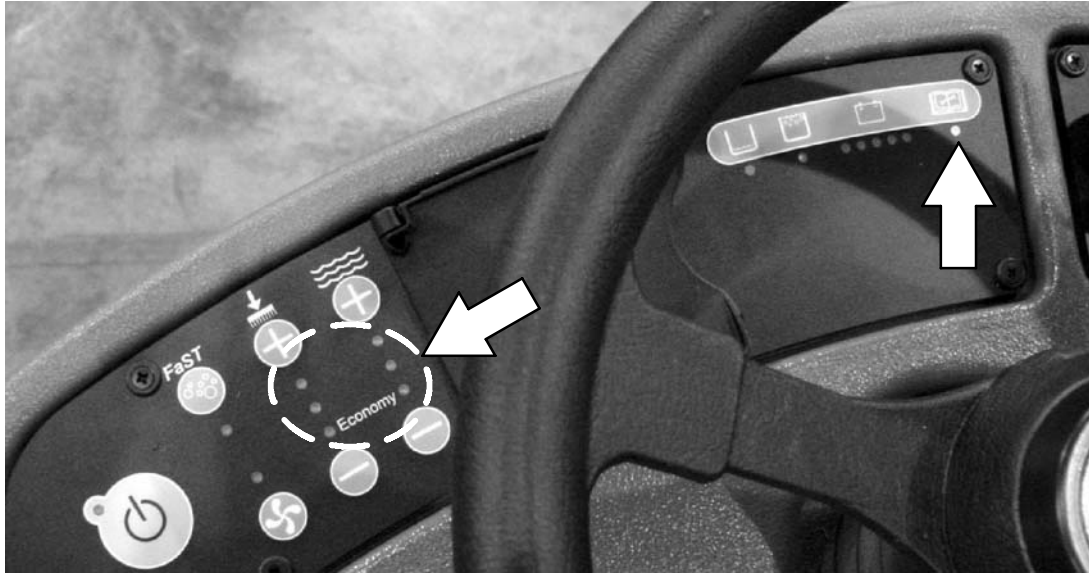

Refer to the table below to determine the cause for the fault or failure.

Indicator(s)	Cause(s)	Remedy
Fault Light blinks	Propel motor is overloaded	Contact Tennant service representative
Fault Light and top Brush Pressure Light both blink	The right or rear Brush Motor is overloaded (possibly from string or banding wrapped around motor)	Remove string / banding from motor or Contact Tennant service representative
Fault Light and bottom Brush Pressure Light both blink	The left or front Brush Motor is overloaded (possibly from string or banding wrapped around motor)	Remove string / banding from motor or Contact Tennant service representative
Fault Light and Vacuum Fan Light both blink	Vacuum Fan Motor is overloaded	Contact Tennant service representative

OPERATION

CIRCUIT BREAKERS

Circuit breakers are resettable electrical circuit protection devices that stop the flow of current in the event of a circuit overload. Once a circuit breaker is tripped, allow breaker to cool and then press the reset button to manually reset the breaker.

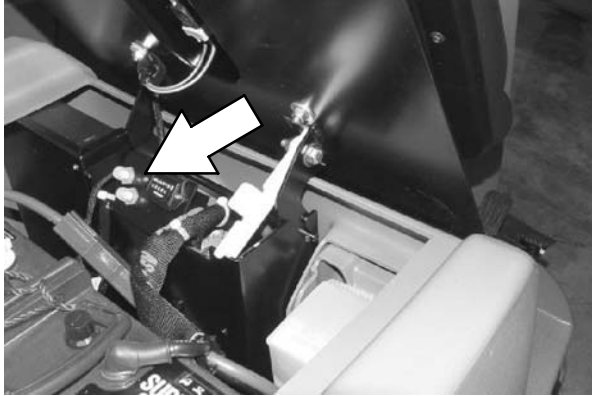

If the overload that caused the *circuit breaker* to trip is still there, the *circuit breaker* will continue to stop current flow until the problem is corrected.

The *circuit breakers* are located inside the battery compartment next to the hour meter.

The chart shows the *circuit breakers* and the electrical components they protect.

Circuit Breaker	Rating	Circuit Protected
CB1	5 A	Instrument Panel - power
CB2	15 A	Accessories

FUSES

The *fuse* is a one-time protection device designed to stop the flow of current in the event of a circuit overload. The 100 A fuse is located inside the battery compartment near the hourmeter. It protects the propel circuit.

NOTE: Always replace the fuse with a fuse of the same amperage.

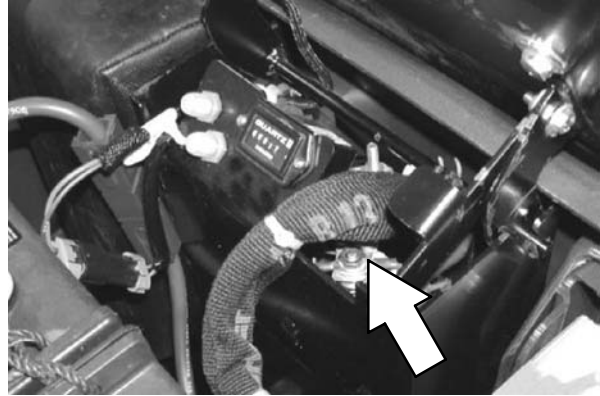

HAZARD LIGHT SWITCH (OPTION)

The Hazard Light Switch operates the optional hazard light.

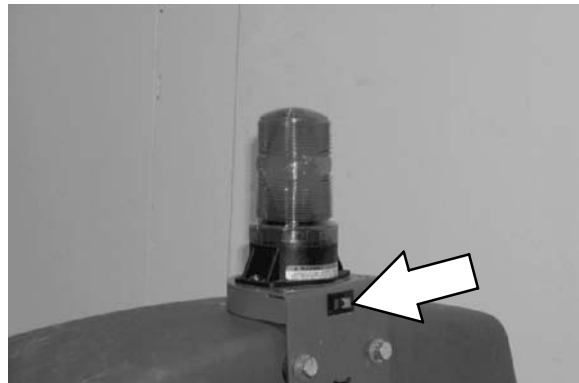

DRAINING AND CLEANING THE TANKS

When cleaning is finished, or when the recovery tank full indicator comes on, the recovery tank should be drained and cleaned. The solution tank then can be filled again for additional cleaning.

1. Drive the machine to a solution disposal drain.
2. Turn the machine *ON/OFF* key switch off.

FOR SAFETY: Before leaving or servicing machine, stop on level surface, and turn off machine.

3. Tilt the operator seat forward and hook the seat latch into place to hold up the seat.

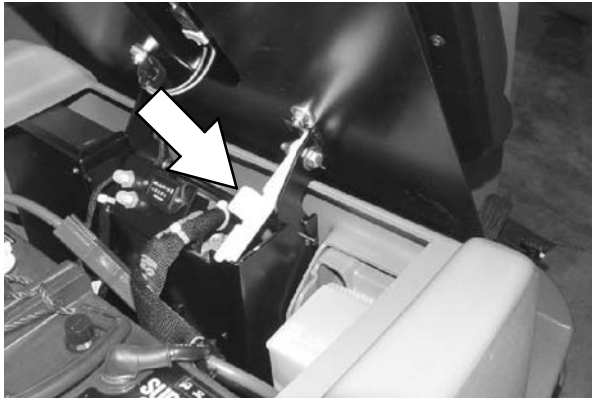

4. Remove the recovery tank drain hose. While holding the hose up, remove the plug, then slowly lower the drain hose to the floor drain or sink.

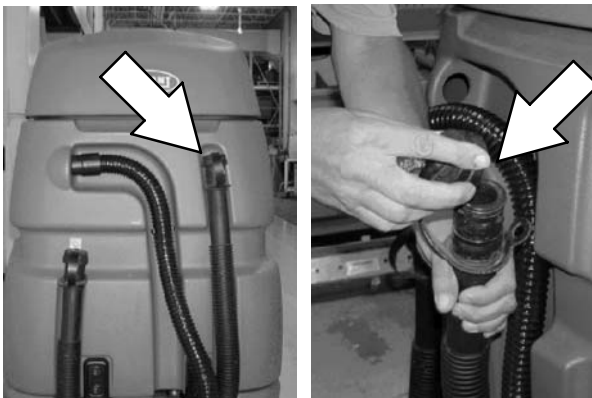

5. Lift the recovery tank cover. Flush the inside of the recovery tank with clean water.

⚠ WARNING: Flammable materials can cause an explosion or fire. Do not use flammable materials in tank(s).

NOTE: DO NOT use steam to clean tanks. Excessive heat can damage tanks and components.

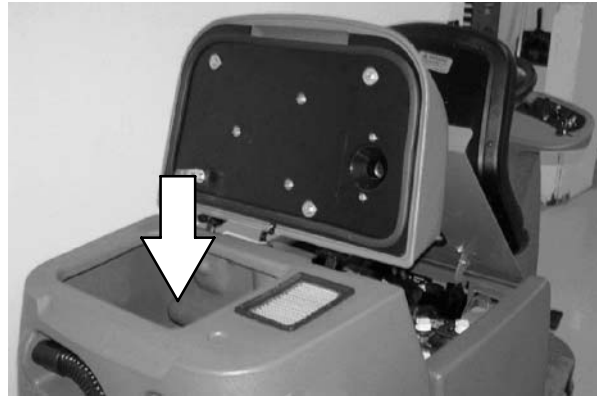

6. Rinse the float sensor located inside the recovery tank.

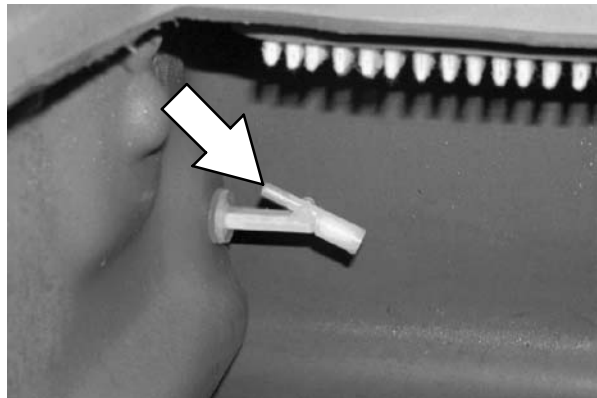

7. Replace the recovery tank drain hose cap and mount the drain hose back onto the mounting clip after the tank is drained.

8. Remove and clean the vacuum fan filter. Clean the filter with a damp cloth or low pressure water hose if dirty. Allow the vacuum fan filter to dry completely before reinstalling it in the machine.



OPERATION

9. Close the recovery tank cover.
10. Remove the solution tank drain hose. While holding the hose up, remove the plug, then slowly lower the drain hose to the floor drain or sink.

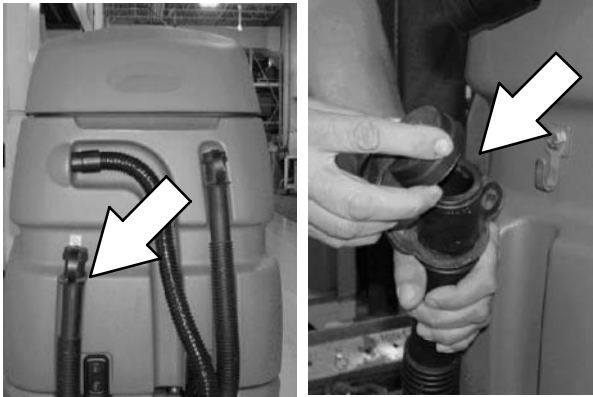

11. Tilt the recovery tank back to access the solution tank. Make sure the recovery tank is empty before tilting.



12. Flush the solution tank and rinse the float sensor located inside the back part of the solution tank. Rinse the screen filter on the bottom of the tank.

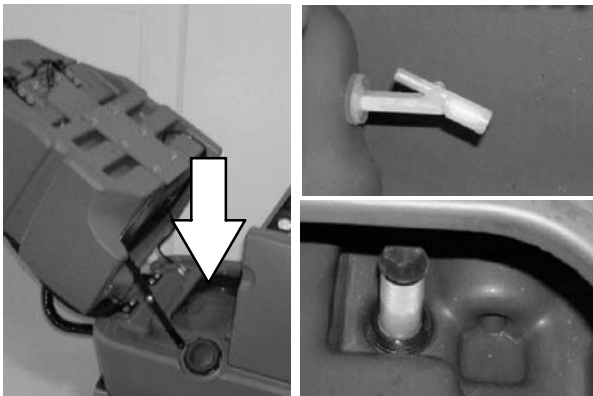

13. Carefully push the recovery tank forward to close the solution tank.

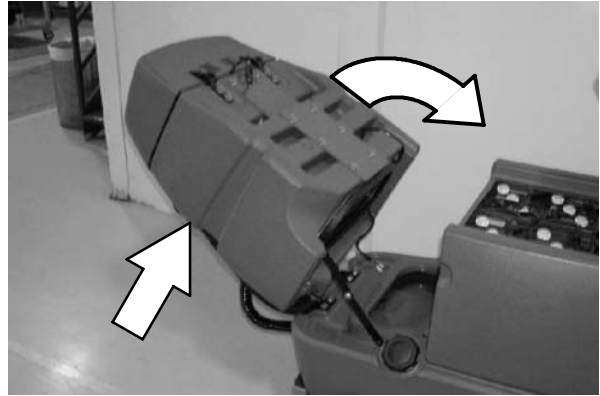

14. Unhook the seat latch and lower the operator seat.

15. Clean the front of the solution tank through the front access port located under the front solution tank cover. Wipe the bottom of the cover and the tank seal before replacing the cover.



16. Cylindrical scrub head: Remove and clean the debris tray. Place the tray back in the scrub head when finished.

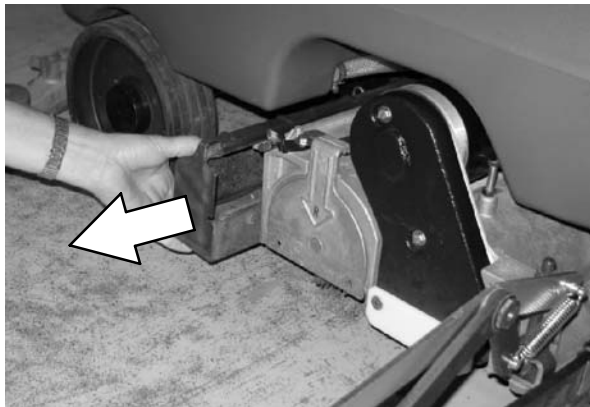

17. Replace the solution tank drain hose cap and mount the drain hose back onto the mounting clip after the tank is drained.

PROPEL SYSTEM TROUBLESHOOTING

The audio alarm (horn) will sound and/or warning lights will come on when a propelling system fault or failure is detected. The machine will stop propelling when this happens. Refer to the table below to determine the cause for the fault or failure.

Indicator(s)	Cause(s)	Remedy
Horn repeatedly beeps 2 times	Propel pedal depressed without operator in seat	Sit in seat when operating machine
Horn repeatedly beeps 4 times	ON/OFF key switch is turned on while propel pedal is engaged	Release the propel pedal before turning key on
Horn repeatedly beeps 5 times	Failure in the Throttle system has occurred	Contact Tennant service representative
Horn repeatedly beeps 6 times	Failure in the Brake system has occurred	Contact Tennant service representative
Horn repeatedly beeps 7 times	Failure in the Parking Brake system has occurred	Contact Tennant service representative
Horn repeatedly beeps 8 times	Emergency Stop Button is engaged	Reset Emergency Stop Button
Horn repeatedly beeps 9 times	ON/OFF key switch is turned on while battery charger is plugged into machine	Unplug battery charger before starting machine
Fault Light blinks	Propel motor is overloaded	Contact Tennant service representative

OPERATION

MACHINE TROUBLESHOOTING

Problem	Cause	Remedy
Trailing water-poor or no water pickup	Vacuum fan turned off	Turn vacuum fan on
	Worn squeegee blades	Rotate or replace squeegee blades
	Squeegee out of adjustment	Adjust squeegee
	Vacuum hose clogged	Flush vacuum hoses
	Vacuum fan filter dirty	Clean vacuum fan filter
	Vacuum fan cover seals worn	Replace seals
	Debris caught on squeegee	Remove debris
	Vacuum hose to squeegee or recovery tank disconnected or damaged	Reconnect or replace vacuum hose
	Recovery tank cover not completely closed	Check for obstructions and close cover
Vacuum fan will not turn on	Vacuum fan switch turned off	Turn vacuum switch on
	Recovery tank full	Drain recovery tank
	Foam filling recovery tank	Empty recovery tank
		Use less detergent
Recovery tank sensor dirty or stuck	Clean or replace sensor	
Little or no solution flow to the floor (Conventional Scrubbing Mode)	Solution tank empty	Fill solution tank
	Solution flow turned off	Turn solution flow on
	Solution supply lines plugged	Flush solution supply lines
	Clogged solution tank filter	Drain solution tank. remove solution tank filter, clean and reinstall
Poor scrubbing performance	One Step Scrub button not on	Turn One Step Scrub button on
	Improper detergent or brushes used	Contact Tennant service representative
	Recovery tank full	Empty recovery tank
	Solution tank empty	Fill solution tank
	Debris caught on scrub brushes or pads	Remove debris
	Worn scrub brush	Replace scrub brush
	Broken or loose brush drive belt (Cylindrical models)	Replace or tighten belt
	Brush pressure set too light	Increase brush pressure
	Low battery charge	Charge batteries until the charger automatically turns off

Problem	Cause	Remedy
FaST System does not operate	FaST switch is turned off	Turn on the FaST switch
	Accessory circuit breaker tripped	Reset circuit breaker
	Clogged FaST-PAK supply hose and/or connector	Soak connector and hose in warm water and clean
	FaST-PAK carton is empty or not connected	Replace FaST-PAK carton and/or connect supply hose
	FaST system is not primed	To prime, operate the FaST solution system for a few minutes
	Clogged solution tank filter	Drain solution tank. remove solution tank filter, clean and reinstall
	Clogged detergent injector	See FaST SYSTEM MAINTENANCE
	Faulty solution pump	Replace solution pump
ec-H2O Model: ec-H2O system indicator light blinking red	Mineral deposit build-up in module	Flush module (See <i>ec-H2O</i> MODULE FLUSH PROCEDURE on page 37)
ec-H2O Model: Alarm sounds		
ec-H2O Model: ec-H2O system indicator light solid red	Defective module	Contact Service Center
ec-H2O Model: ec-H2O system indicator light does not turn on	Defective light or module	Contact Service Center
ec-H2O Model: No water flow	Clogged module	Contact Service Center
	Defective solution pump	Replace solution pump

MAINTENANCE

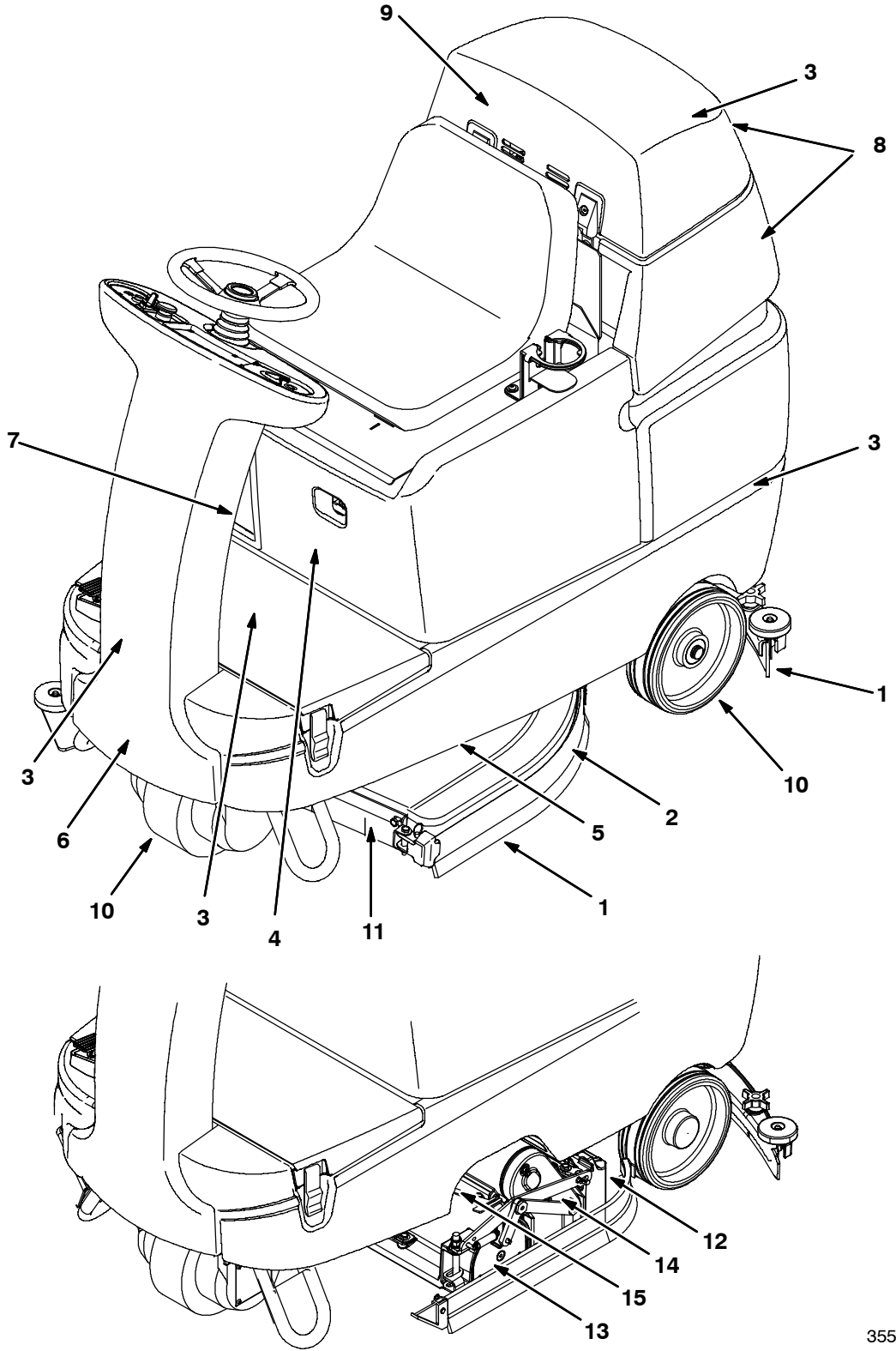

355033

MAINTENANCE CHART

Interval	Key	Description	Procedure	Lubricant/ Fluid	No. of Service Points
Daily	1	Side and rear squeegees	Check for damage and wear	-	3
			Check deflection and leveling	-	6
	2	Scrub brushes / pads	Check for damage, wear, debris	-	2
	8	Recovery tank	Clean tank, screen filter, and float sensor	-	1
	9	Vacuum fan filter	Clean	-	1
	7	FaST-PAK supply hose and connector (option)	Clean and connect hose to storing plug when not in use	-	1
50 Hours	12	Debris tray (Cylindrical brushes)	Clean	-	1
	4	Battery cells (Lead acid batteries)	Check electrolyte level	DW	3
	11	Disk scrub head floor skirt	Check for damage and wear	-	2
100 Hours	13	Cylindrical brushes	Check taper and rotate front to rear	-	2
	3	Vacuum Fan and tank seals	Check for damage and wear	-	3
200 Hours	14	Cylindrical brush drive belts	Check tension	-	2
	4	Battery terminals and cables	Check and clean	-	12
500 Hours	9	Vacuum fan motor(s)	Check motor brushes	-	1
	5	Scrub brush motors	Check motor brushes	-	2
	6	Propelling motor	Check motor brushes	-	1
	10	Tires	Check for damage and wear	-	3
1000 Hours	15	FaST water and air filters (option)	Replace	-	1

LUBRICANT/FLUID

DW Distilled water

BATTERIES

The batteries are designed to hold their power for long periods of time. The lifetime of the batteries is limited to number of charges the batteries receive. To get the most life from the batteries, recharge them immediately when the battery discharge indicator begins to blink.



FOR SAFETY: When servicing machine, wear protective gloves when handling batteries or battery cables. Avoid contact with battery acid.

After every 200 hours of use check for loose battery connections and clean the surface of the batteries, including terminals and cable clamps, using a strong solution of baking soda and water. Brush the solution sparingly over the battery tops. Do not allow any baking soda solution to enter the batteries. Use a wire brush to clean the terminal posts and the cable connectors. Wipe off all cleaning solution residue. After cleaning, apply a coating of clear battery post protectant to the terminals and the cable connectors. Keep the tops of the batteries clean and dry.

Objects made of metal can potentially short circuit the batteries. Keep all metallic objects off the batteries. Replace any worn or damaged wires. Replace any defective batteries. To dispose of batteries, contact a battery dealer or your Tennant Service representative.

GEL BATTERIES

The Gel batteries are maintenance free and do not need to have the electrolyte level checked.

LEAD ACID BATTERIES

Check the electrolyte level in each battery cell before and after charging, and after every 50 hours of operation. Never add acid to the batteries. Add distilled water *only*. Always keep the battery caps on, except when adding water or taking hydrometer readings.

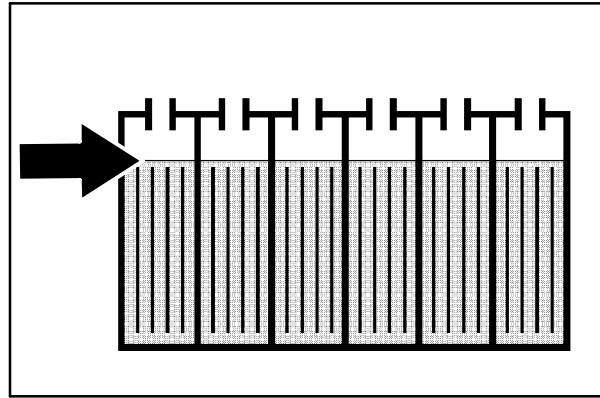

Using a hydrometer, measure the specific gravity to determine the charge level and condition of the batteries. If one or more of the battery cells test lower than the other battery cells (0.050 or more), the cell is damaged, shorted, or is near failure. Completely recharge the batteries and then retest.

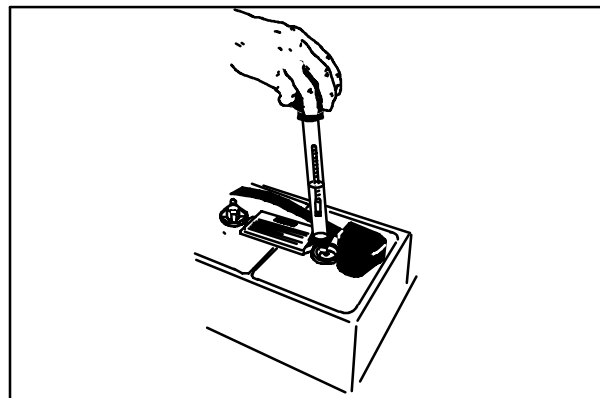

0438C

NOTE: Do not take readings immediately after adding distilled water. If the water and acid are not thoroughly mixed, the readings may not be accurate. Check the hydrometer readings against the following chart to determine the remaining battery charge level:

SPECIFIC GRAVITY at 27° C (80° F)	BATTERY CHARGE
1.265	100% Charged
1.223	75% Charged
1.185	50% Charged
1.148	25% Charged
1.110	Discharged

NOTE: If the readings are taken when the battery electrolyte is any temperature other than 27° C (80° F), the reading must be temperature corrected. Add or subtract to the specific gravity reading 0.004, 4 points, for each 6° C (10° F) above or below 27° C (80° F).

CHARGING THE BATTERIES WITH OFF-BOARD CHARGER

1. Drive the machine to a flat, dry surface.

NOTE: Make sure the area is well ventilated.

2. Turn the machine ON/OFF key switch off.

FOR SAFETY: Before leaving or servicing machine, stop on level surface, and turn off machine.

3. Tilt the operator seat forward and hook the seat latch into place to hold up the seat



4. Lead acid batteries: Check the water level in all battery cells. If the level is low, add just enough distilled water to cover the plates. **DO NOT OVERFILL.** The batteries can overflow during charging due to expansion.

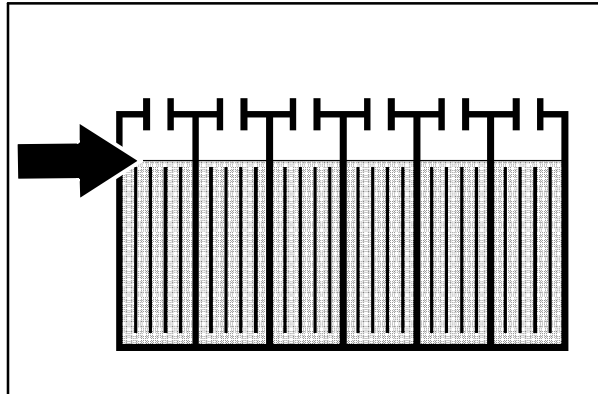

NOTE: Make sure the battery caps are in place while charging.

FOR SAFETY: When servicing machine, wear protective gloves when handling batteries or battery cables. Avoid contact with battery acid.

5. Plug the charger connector into the machine battery charging connector.

WARNING: Batteries emit hydrogen gas. Explosion or fire can result. Keep sparks and open flame away. Keep covers open when charging.

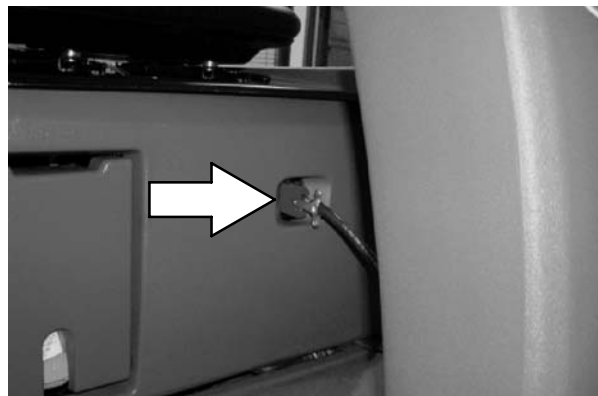

MAINTENANCE

6. Plug the battery charger into the wall outlet.

NOTE: If the red “ABNORMAL CYCLE” lamp lights when the TENNANT charger is plugged into a wall outlet, the charger cannot charge the battery and there is something wrong with the battery.

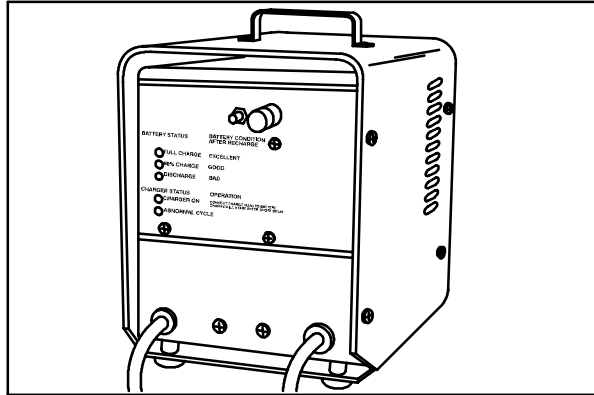

7. The TENNANT charger will start automatically. When the batteries are fully charged, the TENNANT charger will automatically turn off.

NOTE: Do not disconnect the charger's DC cord from the machine's battery charging connector when the charger is operating. Arcing may result. If the charger must be interrupted during charging, disconnect the AC power supply cord first.

8. After the charger has turned off, unplug the charger from the machine battery charging connector.
9. Lead acid batteries: Check the electrolyte level in each battery cell after charging. If needed, add distilled water to raise the electrolyte level to about 12 mm (0.4 in) below the bottom of the sight tubes.
10. Unhook the seat latch and lower the operator seat.

CHECKING ON-BOARD BATTERY CHARGER SETTINGS

If your machine is equipped with the on-board charger, the charger settings must be set for your battery type before charging. Failure to properly set will result in battery damage.

To determine your battery type, see battery label. Contact your battery supplier if not specified.

To verify the setting of the charger, connect the charger cord into an electrical receptacle. The charger will display a sequence of codes. One of the codes will either read “GEL” or “Acid”.

GEL = Set for sealed/maintenance free batteries.
Acid = Set for wet/lead acid batteries.

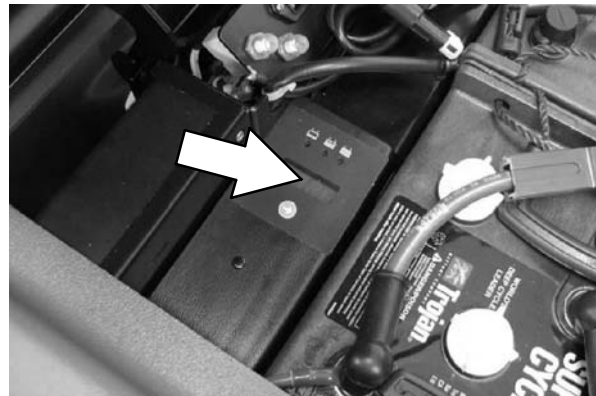

To change the settings to use a different type of battery, contact your Tennant Service representative.

CHARGING THE BATTERIES WITH THE ON-BOARD CHARGER

NOTE: If your machine is equipped with the on-board battery charger, make sure that the charger is properly set for your battery type before charging (See CHECKING ON-BOARD BATTERY CHARGER SETTINGS).

1. Drive the machine to a flat, dry surface.

NOTE: Make sure the area is well ventilated.

2. Turn the machine ON/OFF key switch off.

FOR SAFETY: Before leaving or servicing machine, stop on level surface, and turn off machine.

3. Tilt the operator seat forward and hook the seat latch into place to hold up the seat

WARNING: Batteries emit hydrogen gas. Explosion or fire can result. Keep sparks and open flame away. Keep covers open when charging.

4. Connect the charger's AC power supply cord into a properly grounded wall outlet.

5. The charger will display a sequence of codes once the cord is connected.

Three-digits + the following code:

- A = Charging current
- U = Battery Voltage
- h = Charging time
- C = Charging ampere-hours [Ah]
- E = Energy used [Kwh]

6. Press the arrow button to review the codes.

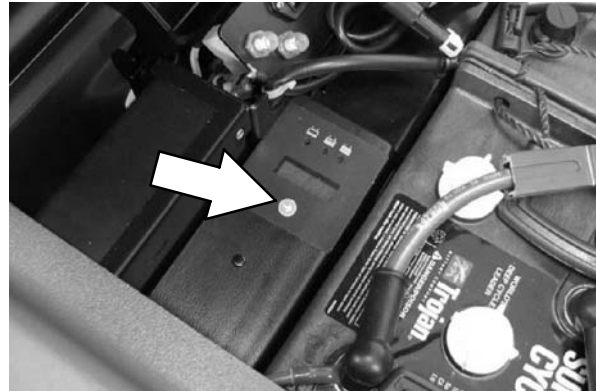

Once the charging cycle begins, the indicator lights will progress from red, yellow to green. When the green indicator light comes on, the charging cycle is done. Unplug the charger cord.

If the charger detects a problem, the charger will display an error code. See *ON-BOARD BATTERY CHARGER ERROR CODES*.

ON-BOARD BATTERY CHARGER ERROR CODES

DISPLAY CODE	FAULT	SOLUTION
bat	Loose or damaged battery cable	Check battery cable connections.
	Battery exceeded maximum voltage level.	No action necessary.
E01	Exceeded maximum battery voltage allowed.	No action necessary.
E02	Safety thermostat exceeded maximum internal temperature.	Check if the charger vents are obstructed.
E03	Exceeded maximum time for charging phase leaving the batteries undercharged due to a sulfated or faulty battery.	Repeat the charging cycle and if the error code E03 reappears check battery or replace it.
SCt	Safety timer exceeded maximum charging time. Interrupts charging cycle.	Replace battery.
Srt	Possible internal short circuit.	Contact Service Center.

MAINTENANCE

ELECTRIC MOTORS

The carbon brushes on the vacuum fan motor, the propelling motor, and the scrub brush motors should be inspected after the initial 500 hours of machine operation and then every 100 hours after the initial 500 hours.

BELTS (Cylindrical Models)

The two brush drive belts are located on the cylindrical brush scrub head. The belts drive the cylindrical brushes. Proper belt tension is a 6 mm (0.25 in) deflection from a force of 2.3 to 2.5 kg (5.0 to 5.4 lb) at the belt midpoint.

Check and adjust the belt tension every 100 hours of operation.

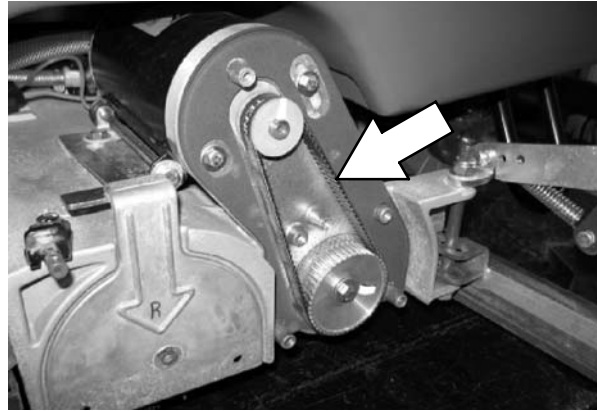

SCRUB BRUSHES AND PADS

The machine can be equipped with either *disk* or *cylindrical* scrub brushes, or cleaning pads. Check scrub brushes daily for wire or string tangled around the brush or brush drive hub. Also check for brushes damage and wear.

DISK BRUSHES

The scrub brushes should be replaced if a large number of bristles are missing or if bristle length is less than 10 mm (0.38 in).

Cleaning pads must be placed on pad drives before they are ready to use. The cleaning pad is held in place by a pad holder.

Cleaning pads need to be cleaned immediately after use with soap and water. Do not wash the pads with a pressure washer. Hang pads, or lie pads flat to dry.

NOTE: Always replace brushes and pads in sets. Otherwise one brush or pad will be more aggressive than the other.

REPLACING DISK BRUSHES OR PAD DRIVER

1. Stop machine on a level surface. Make sure the scrub head is in the raised position.
2. Turn the machine *ON/OFF* key switch off.

FOR SAFETY: Before leaving or servicing machine, stop on level surface, and turn off machine.

3. Pull the pin from the side squeegee retainer pivot.

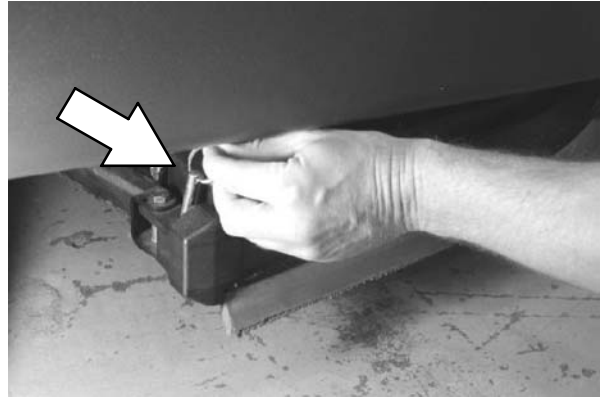

4. Open the side squeegee retainer pivot toward the front of the machine, then pull the side squeegee toward the rear of the machine to access the scrub brushes or pads.



MAINTENANCE

5. Pull the scrub brush/pad driver downward to remove it from the drive hub.

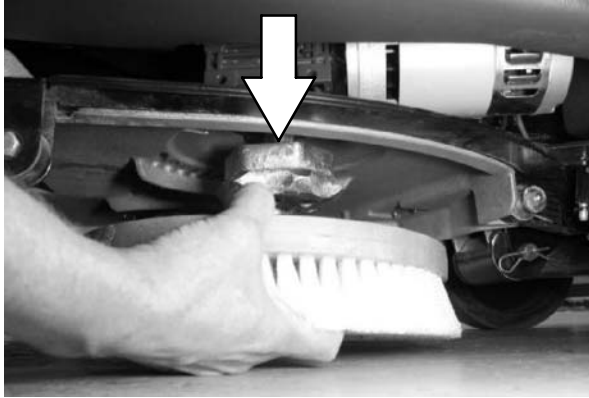

6. Place the new scrub brush/pad driver onto the drive hub. Ensure that it is securely mounted onto the brush drive hub.

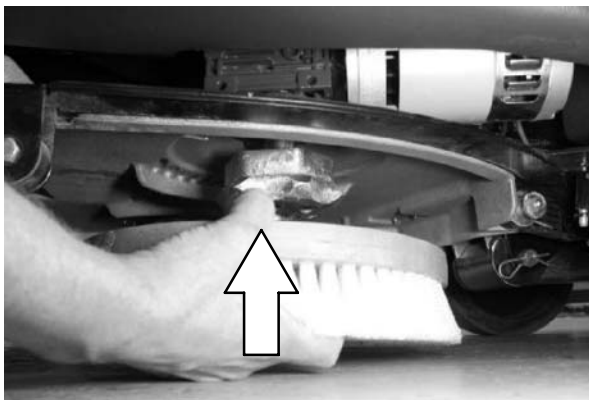

7. Close the side squeegee and the retainer pivot, then insert the pin.

NOTE: Be sure the pin is inserted completely through the bottom.

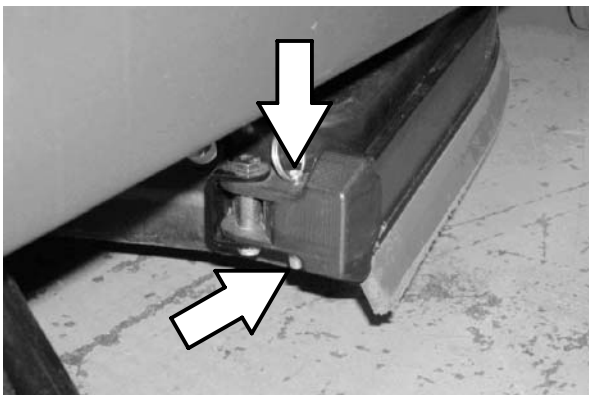

REPLACING DISK PADS

1. Remove the pad driver from the machine.
2. Squeeze the spring clip together to remove the center disk.

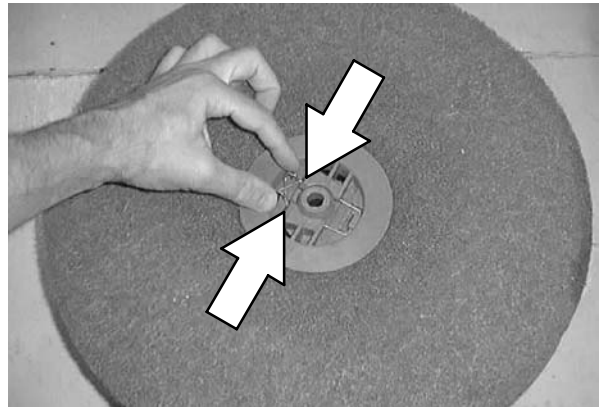

3. Flip or replace the scrub pad, center the scrub pad on the pad driver. Then reinstall the center disk to secure the pad in place on the pad driver.

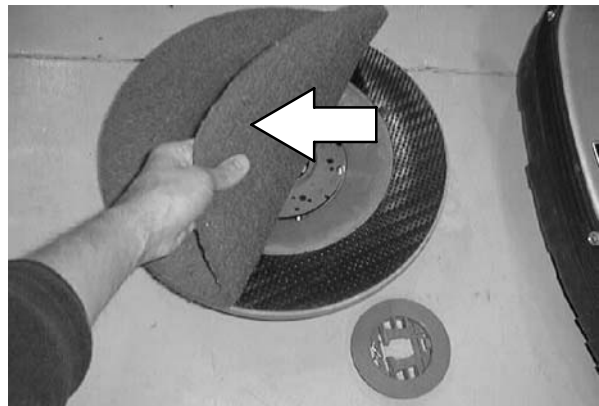

4. Reinsert the pad driver into the machine.

CYLINDRICAL BRUSHES

Check the brush taper and rotate the brushes from front-to-rear every 50 hours of machine operation for maximum brush life and best scrubbing performance.

The cylindrical brushes should be replaced if large amounts of bristles are missing, or if the remaining bristle length is less than 15 mm (0.62 in).

NOTE: Replace worn brushes in pairs. Scrubbing with brushes of unequal bristle length will result in diminished scrubbing performance.

REPLACING OR ROTATING CYLINDRICAL BRUSHES

1. Stop machine on a level surface. Make sure the scrub head is in the raised position.
2. Turn the machine *ON/OFF* key switch off.

FOR SAFETY: Before leaving or servicing machine, stop on level surface, and turn off machine.

3. Remove the cotter pin that holds the side squeegee in place. Swing the squeegee away from the scrub head.

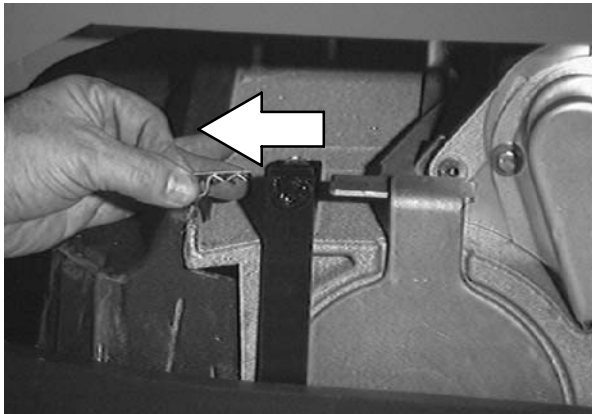

4. Remove idler plate from the scrub head by pressing the spring tab downward.

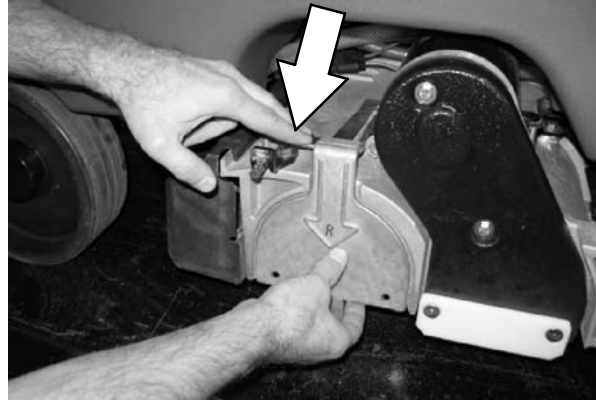

5. Pull the old brush out of the scrub head.
6. Attach the idler plate to the new or rotated brush on the end that has the double row of bristles. Install the brush.

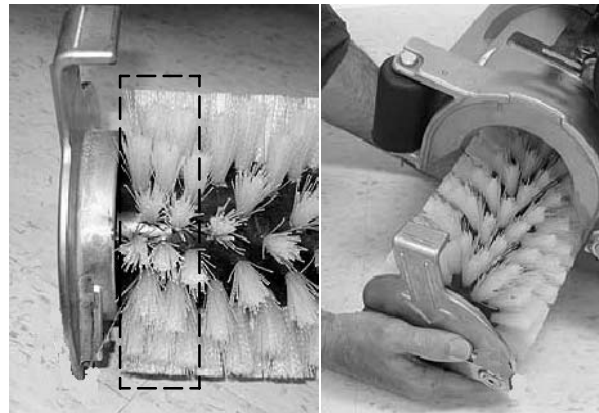

7. Push down on the door to catch the door in the scrub head, then pull up on the door to latch it into the spring.
8. Repeat for the other brush on the other side of the scrub head

NOTE: Each side of the scrub head is stamped with a letter. The idler door of that side of the scrub head is stamped with the same letter. Make sure the letter on the door matches the letter on the scrub head when replacing the doors.

MAINTENANCE

CHECKING CYLINDRICAL BRUSH PATTERN

1. Apply chalk, or a similar marking material, to a smooth and level section of the floor.

NOTE: If chalk or other material is not available, allow the brush to spin on the floor for two minutes. A polish mark will remain on the floor.

2. Raise the scrub head, then position the brushes over the chalked area.
3. Block the front or rear wheels to prevent the machine from moving.
4. Lower the scrub head in the chalked area and slowly press the propel pedal until the scrub brushes start spinning. Allow the machine to scrub in the same place for 15 to 20 seconds.
5. Raise the scrub head and drive the machine away from the chalked area.

FOR SAFETY: Before leaving or servicing machine, stop on level surface, and turn off machine.

6. Observe the brush patterns. If the brush pattern is the same width across the entire length of each brush and both brushes are the same width, no adjustment is necessary.

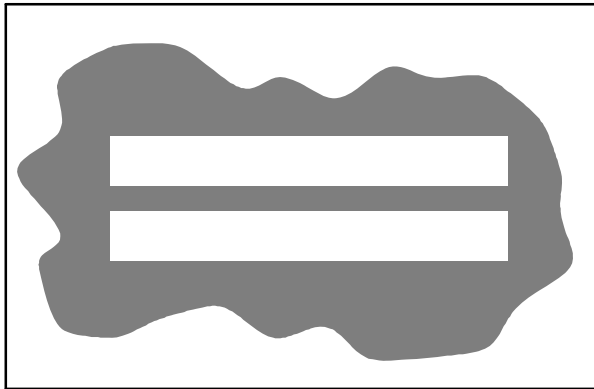

10355

7. If the brush patterns are tapered, see *ADJUSTING CYLINDRICAL BRUSH TAPER* section of this manual.

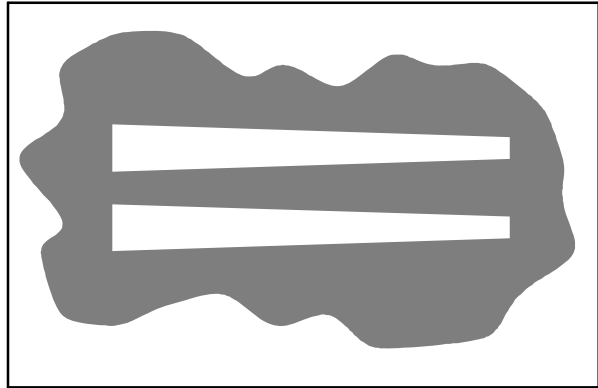

10652

8. If the width of the brushes is not the same, see *ADJUSTING CYLINDRICAL BRUSH WIDTH* section of this manual.

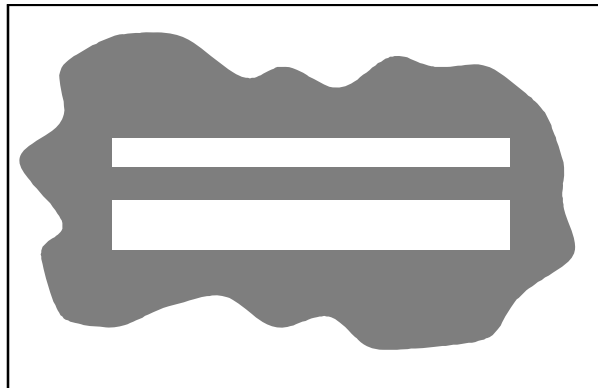

10653

ADJUSTING CYLINDRICAL BRUSH TAPER

FOR SAFETY: Before leaving or servicing machine, stop on level surface, and turn off machine.

1. Stop machine on a level surface. Make sure the scrub head is in the raised position.
2. Turn the machine *ON/OFF* key switch off.

FOR SAFETY: Before leaving or servicing machine, stop on level surface, and turn off machine.

3. Remove the cotter pin that holds the side squeegee in place. Swing the squeegee away from the scrub head.

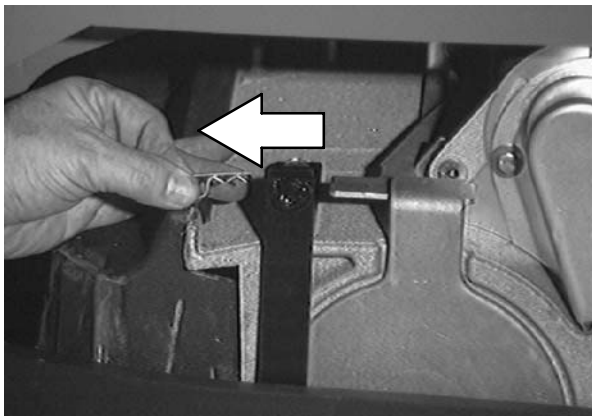

4. Remove idler plate from the scrub head by pressing the spring tab downward.

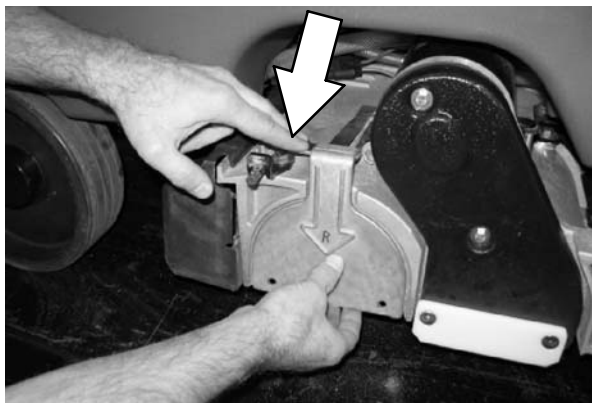

5. While holding the flat end of the idler shaft with a wrench, loosen the mounting screw on the outside of the idler door.

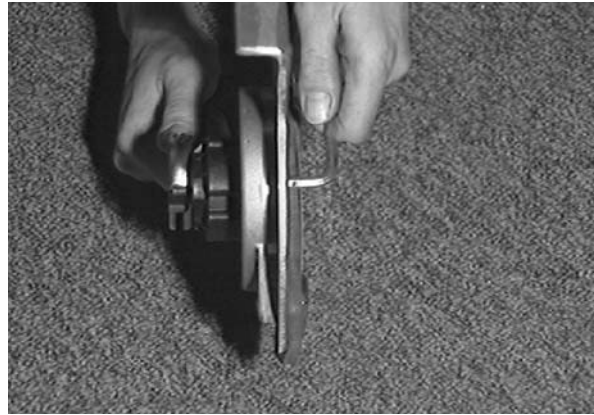

6. Turn the idler shaft to raise or lower the end of the brush as needed to straighten the brush pattern. Tighten the mounting screw.

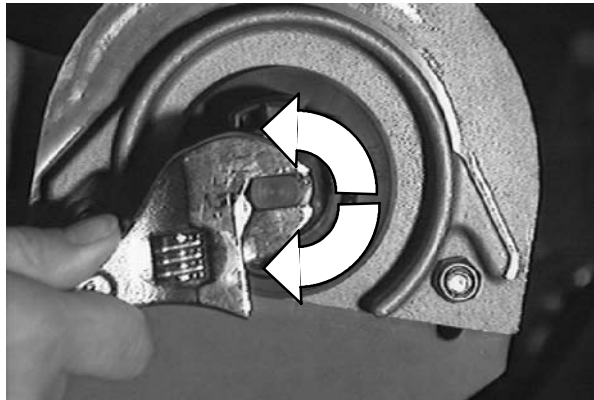

7. Check the brush patterns again and readjust as necessary until both patterns are the same.

MAINTENANCE

ADJUSTING CYLINDRICAL BRUSH WIDTH

1. Stop machine on a level surface. Make sure the scrub head is in the lowered position.
2. Turn the machine *ON/OFF* key switch off.

FOR SAFETY: Before leaving or servicing machine, stop on level surface, and turn off machine.

3. Loosen the two scrub head mounting screws.

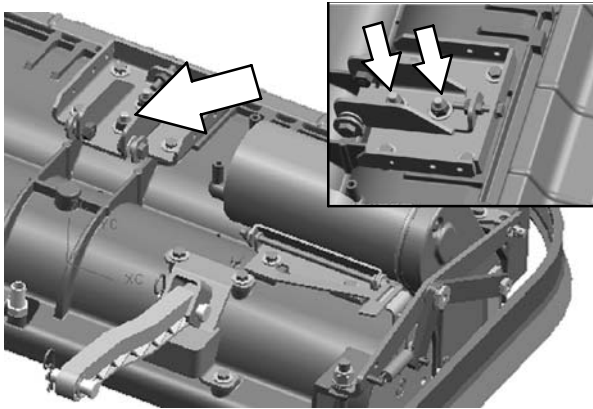

4. Loosen the jam nut, then adjust the brush width adjustment screw. Tighten the jam nut and the two scrub head mounting screws when finished.

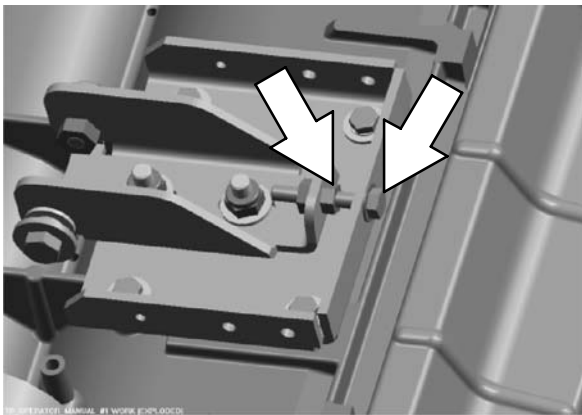

5. Check the brush patterns again and readjust as necessary until both brush patterns are the same.

FaST SYSTEM MAINTENANCE (FaST Model)

Every 1000 hours replace the water filter and air filter located in the FaST detergent injector. Order filter kit p/n 9003009.

1. To access the detergent injector assembly, lower the scrub head. The injector assembly is located on top of the scrub head.

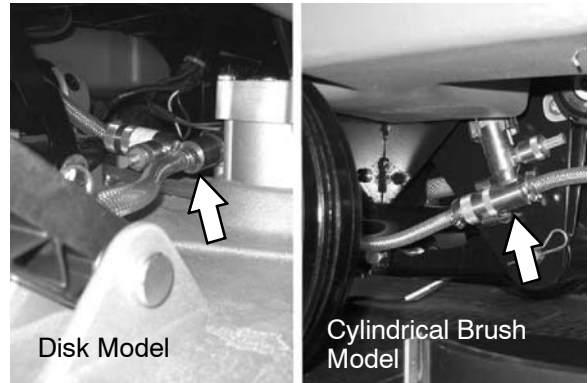

2. Remove the injector assembly from the pinch clamps.
3. Replace the water and air filter. An 8mm hex wrench is required to install the new water filter.



FaST SUPPLY HOSE CONNECTOR

The FaST supply hose connector is located below the FaST-PAK holder. Soak the connector in warm water if detergent buildup is visible. When a FaST-PAK carton is not installed, store the supply hose connector on the storing plug to prevent the hose from clogging.

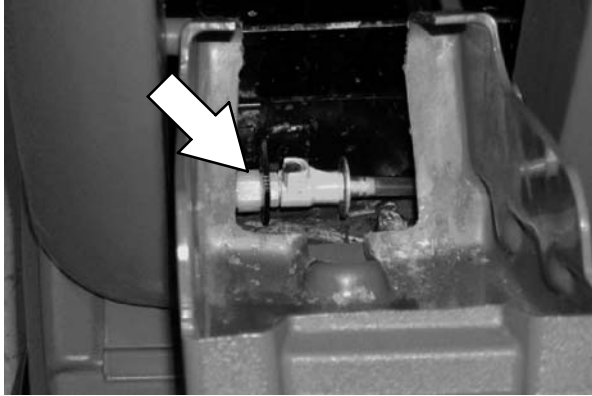

FOR SAFETY: When servicing machine, wear protective gloves and eye protection when handling vinegar.

3. Disconnect the black connector fitting at the scrub head and place the hose into a bucket.

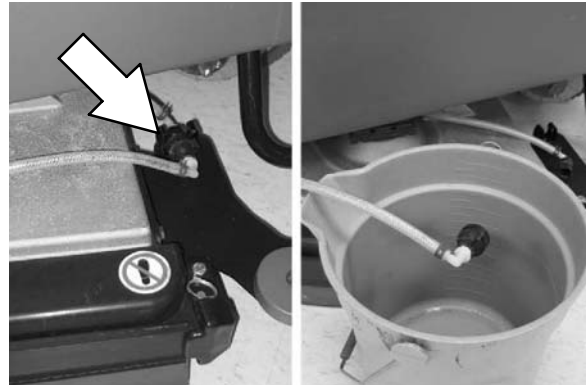

ec-H2O SYSTEM (ec-H2O Model)

ec-H2O MODULE FLUSH PROCEDURE

This procedure is only required when an alarm sounds and the ec-H2O system indicator light begins to blink red.

1. Drain the solution tank and recovery tank of all water.
2. Pour 2 gallons (8 liters) of white or rice vinegar into the solution tank at full strength. Do not dilute. Use the rear fill port when adding vinegar. Do not use the front fill port.

NOTE: Use **white or rice vinegar** only. The acidity level should be between 4-8%. **Do not** use other acids for this procedure.

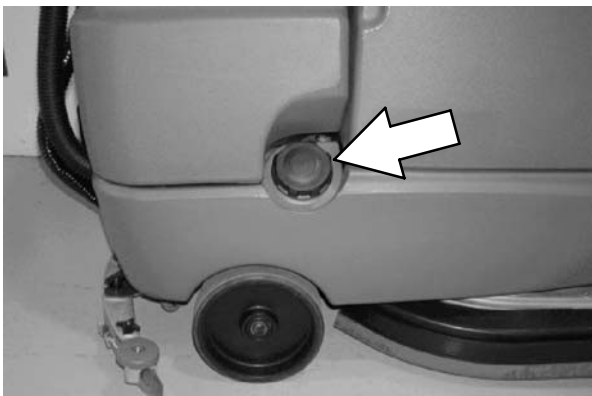

4. Turn the key to the on position.
5. Press and release the ec-H2O module flush switch to start the flush cycle. The module is located under the seat

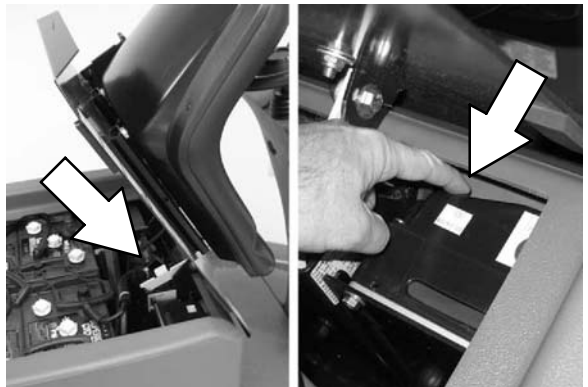

NOTE: The module will automatically shut off when the flush cycle is complete (approx. 7 minutes). The module must run the full 7 minute cycle in order to reset the system indicator light and alarm.

6. After the 7 minute flush cycle, drain, rinse and fill solution tank with clean water. Then press the flush switch again to rinse out any remaining vinegar from module. After 1-2 minutes, press the flush switch to turn off the module.

Repeat flush procedure if the ec-H2O module does not reset. If module fails to reset, contact an Authorized Service Center.

SQUEEGEE BLADES

The side squeegees control water spray and channel water into the path of the rear squeegee. The side squeegee blades are not adjustable.

The rear squeegee assembly channels water into the vacuum fan suction. The front blade channels the water and the rear blade wipes the floor.

Check the squeegee blades daily for damage and wear. Rotate or replace the squeegee blades if the leading edge is torn or worn half-way through the thickness of the blade. Replace the side squeegee deflectors if they become worn.

The rear squeegee can be adjusted for leveling and deflection. The deflection and leveling of the squeegee blades should be checked daily, or when scrubbing a different type of floor.

The rear squeegee assembly can be removed from the squeegee pivot to prevent damage during transport of the machine.

REPLACING (OR ROTATING) THE REAR SQUEEGEE BLADES

1. Stop machine on a level surface. Make sure the scrub head is in the raised position.
2. Turn the machine *ON/OFF* key switch off.

FOR SAFETY: Before leaving or servicing machine, stop on level surface, and turn off machine.

3. Remove the squeegee suction hose from the rear squeegee assembly. Then loosen both rear squeegee assembly mounting knobs.

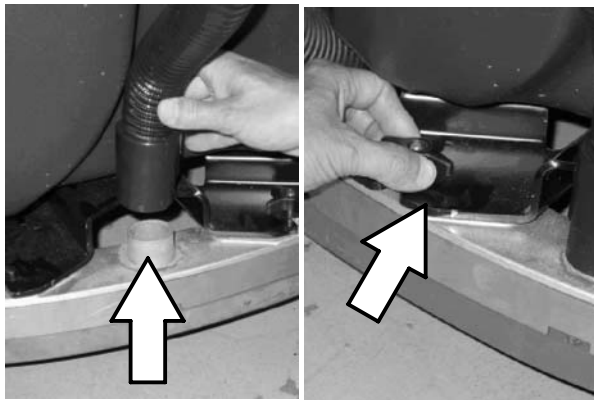

4. Pull the rear squeegee assembly from the machine.

5. Loosen the rear squeegee retaining band tension latch and remove the retaining band.

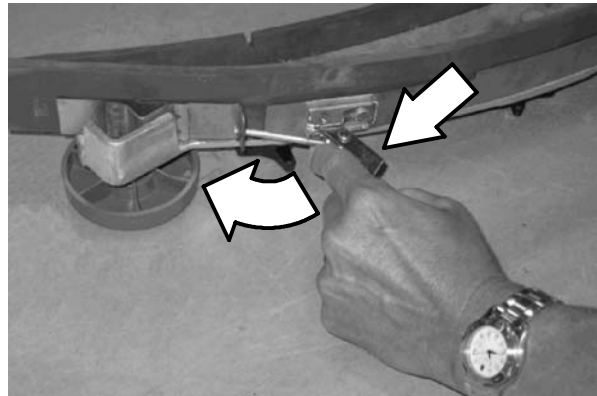

6. Remove rear squeegee blade from the rear squeegee assembly.

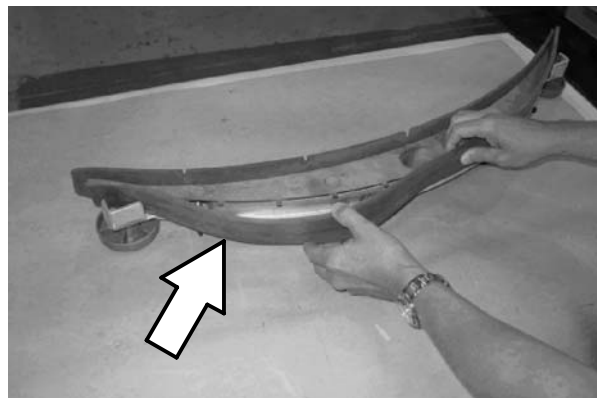

7. Loosen the two outer knobs on the rear squeegee assembly. Remove the front squeegee blade from the squeegee assembly.

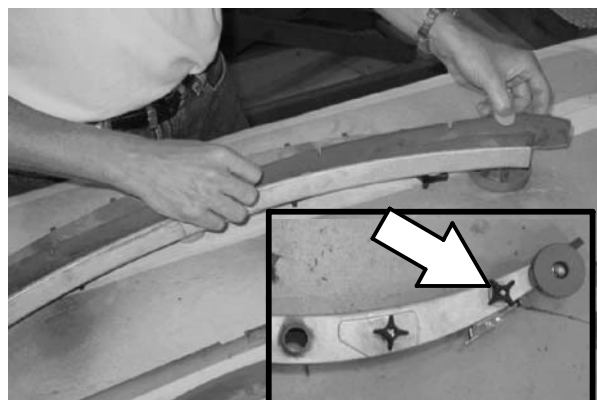

8. Install the new front squeegee blade or rotate the existing blade to the new edge. Be sure the holes in the front squeegee blade are hooked onto the tabs on the front blade clamp.

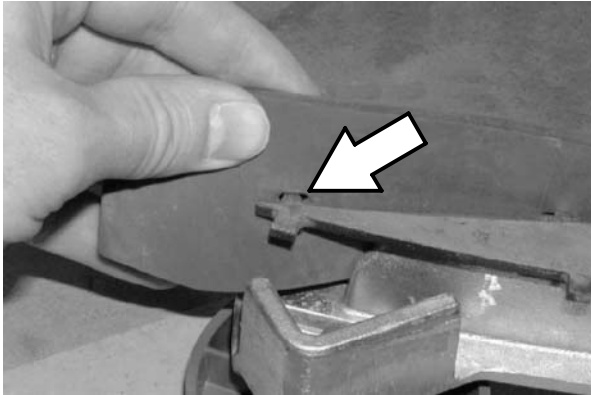

9. Lightly tighten the two outer knobs.
10. Install the new rear squeegee blade or rotate the existing blade to the new edge. Be sure the holes in the squeegee blade are hooked onto the tabs on the squeegee assembly.

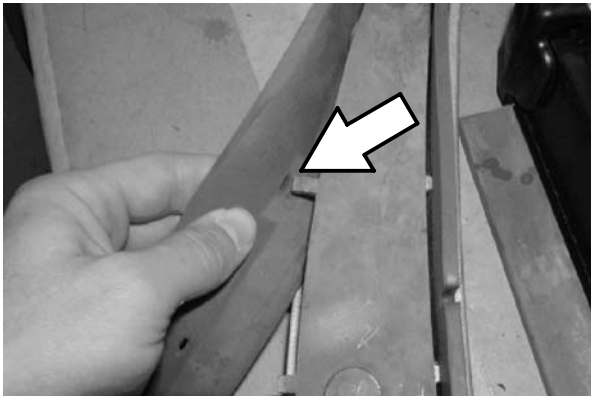

11. Reinstall the rear squeegee retaining band onto the squeegee assembly. Be sure each of the flanges on the retaining band are seated in the cut outs in the rear squeegee assembly.

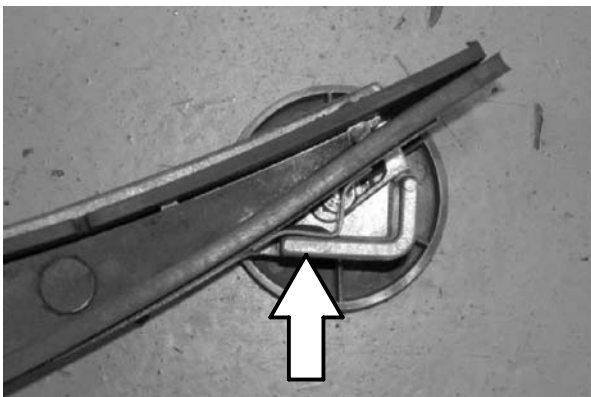

12. Tighten the rear squeegee retaining band tension latch.

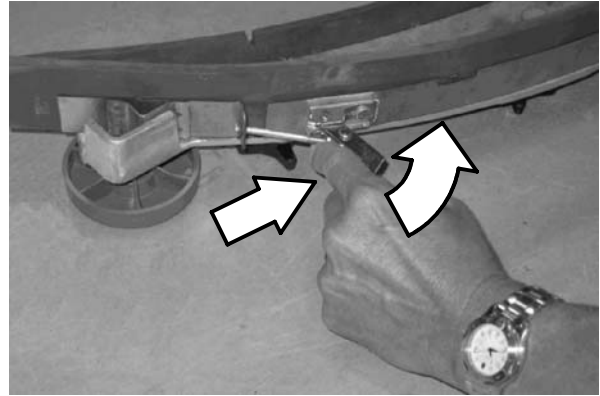

13. Reinstall the rear squeegee under the squeegee mount bracket and tighten all four knobs.

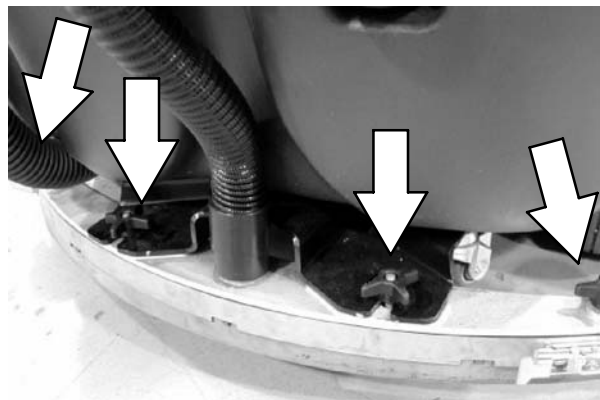

14. Reinstall the squeegee suction hose onto the rear squeegee assembly.

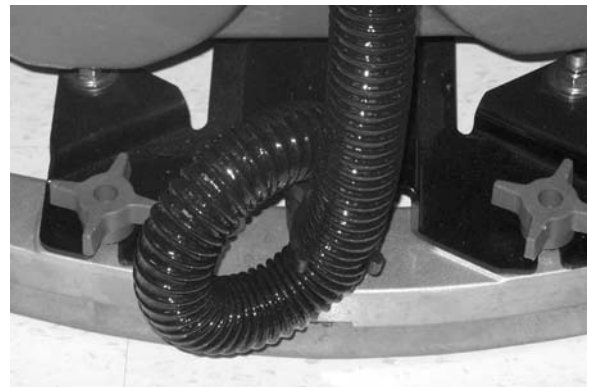

MAINTENANCE

REPLACING SIDE SQUEEGEE BLADES

1. Open the side squeegee.
2. Pull the old side squeegee blade from the side squeegee retainer. Slide the new blade onto the retainer.

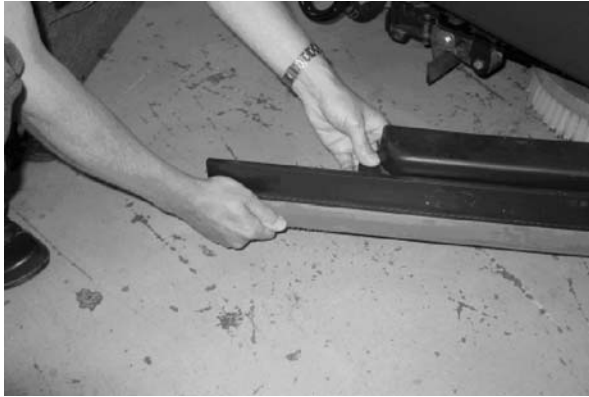

3. Close the side squeegee.

ADJUSTING THE SQUEEGEE GUIDE ROLLER

The squeegee guide rollers are located on both ends of the rear squeegee. The rollers guide the squeegee blade end along a wall. Loosen the nut located at the top of the guide roller and move the roller in or out to adjust how close the end of the squeegee blade is to the wall. The squeegee blade end should be further away from the wall when the floor curves up into the wall.

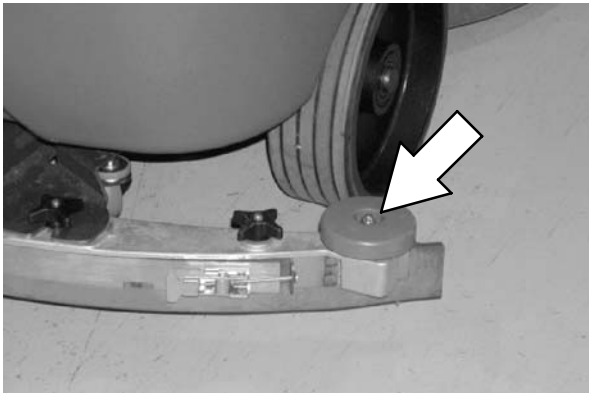

LEVELING THE REAR SQUEEGEE

Leveling of the squeegee assures the entire length of the squeegee is in even contact with the surface being scrubbed. Perform this adjustment on an even and level floor.

1. Lower the squeegee and drive the machine forward a few feet.
2. Turn off the machine *ON/OFF key switch*.

FOR SAFETY: Before leaving or servicing machine, stop on level surface, and turn off machine.

3. Look at the deflection of the squeegee over the full length of the squeegee blade.
4. If the deflection is not the same over the full length of the blade, turn the squeegee leveling bolt to make adjustments.

The squeegee leveling bolt is located directly behind the squeegee suction hose. **DO NOT disconnect the suction hose from the squeegee frame when leveling squeegee.**

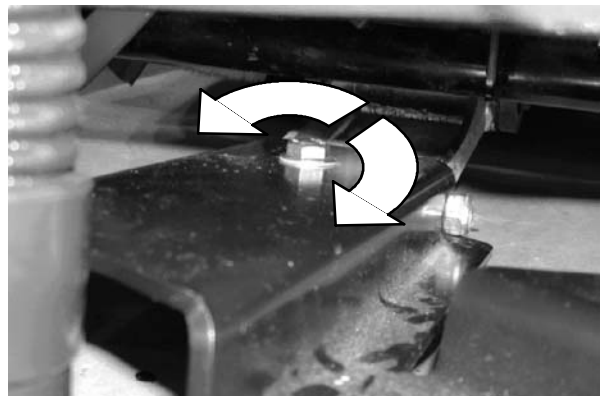

Turn the squeegee leveling bolt counter-clockwise to increase the deflection at the ends of the squeegee.

Turn the squeegee leveling bolt clockwise to decrease the deflection at the ends of the squeegee blade.

5. Drive the machine forward with the squeegee down to recheck the squeegee blade deflection if adjustments were made.
6. Readjust the squeegee blade deflection if necessary.

ADJUSTING REAR SQUEEGEE BLADE DEFLECTION

Deflection is the amount of curl the overall squeegee blade has when the machine moves forward. The best deflection is when the squeegee wipes the floor dry with a minimal amount of deflection.

1. Lower the squeegee and drive the machine forward a few meters (feet).
2. Turn off the machine *ON/OFF key switch*.

FOR SAFETY: Before leaving or servicing machine, stop on level surface, and turn off machine.

3. Look at the amount of deflection or “curl” of the squeegee blade. The correct amount of deflection is 12 mm (0.50 in) for scrubbing smooth floors and 15 mm (0.62 in) for rough floors.

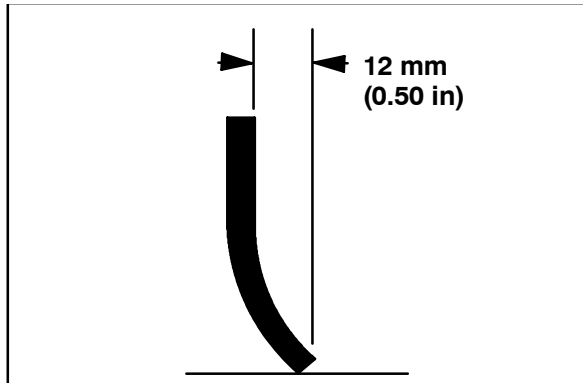

03719

4. If the overall squeegee blade deflection needs to be adjusted, loosen the jam nuts on the squeegee casters and adjust the height.

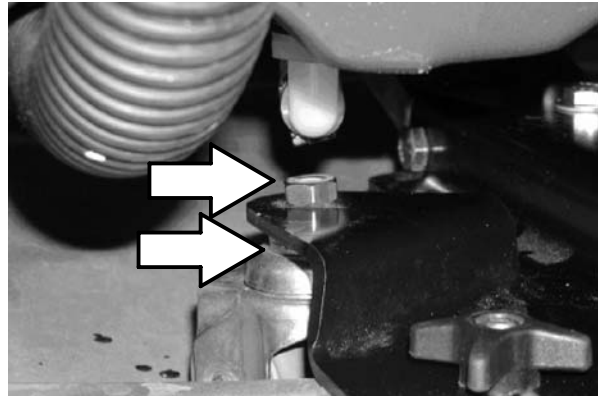

5. Drive the machine forward again to recheck the squeegee blade deflection after adjustments are made.
6. Readjust the squeegee blade deflection if necessary.

MAINTENANCE

SKIRTS AND SEALS

DISK SCRUB HEAD FLOOR SKIRT

The skirt is located in front of the disc brush scrub heads. Check the skirt for damage and wear after every 50 hours of operation.

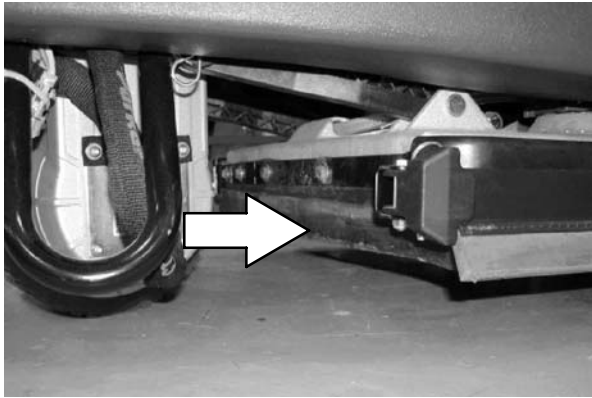

The skirts should clear the floor by 0 to 6 mm (0 to .25 in) when the scrub brushes are new and the scrub head is down.

RECOVERY TANK SEAL

The recovery tank seal is located on the bottom of the recovery tank cover. Check the seal for damage and wear after every 100 hours of operation.

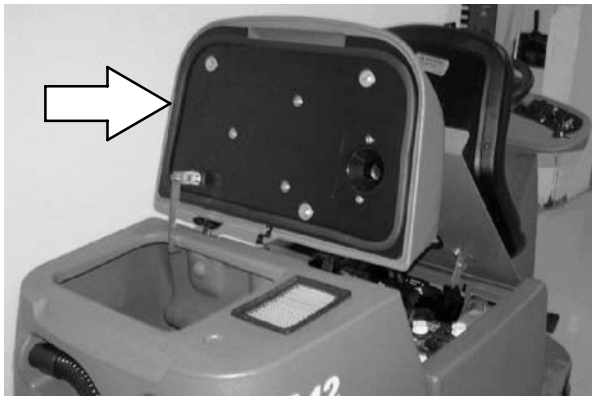

SOLUTION TANK SEALS

There are two solution tank seals. Check the seal for damage and wear after every 100 hours of operation.

A front seal is located on the bottom of the solution tank cover. A rear seal is located on the bottom of the recovery tank.

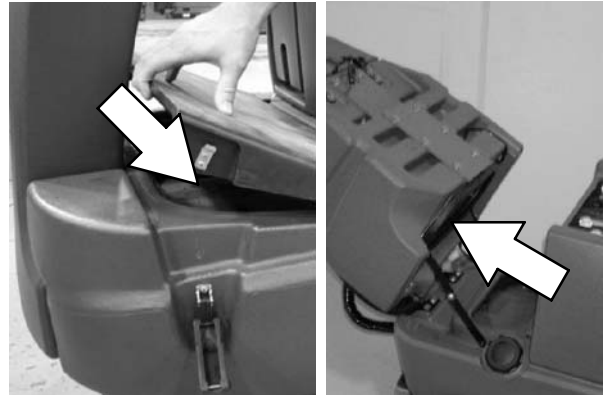

TIRES

The machine has three solid rubber tires: one tire is front and two are in the rear. Check the tires for damage and wear after every 500 hours of operation.

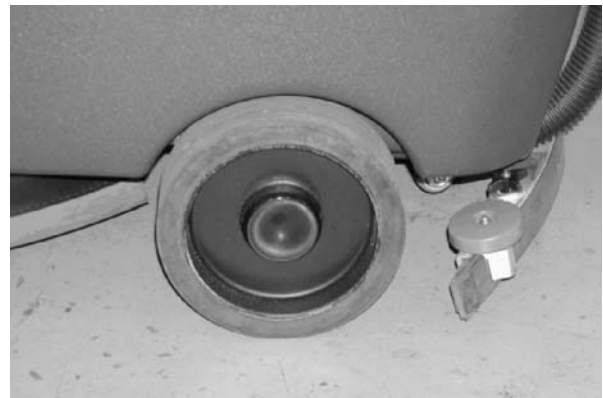

PUSHING, TOWING, AND TRANSPORTING THE MACHINE

PUSHING OR TOWING THE MACHINE

If the machine becomes disabled, it can be pushed from the front or rear, but only tow it from the front.

FOR SAFETY: When servicing machine, do not push or tow the machine on inclines with the brake disabled.

Before attempting to push or tow the machine, disengage the brake as described below.

To disengage the brake, insert the tip of a small screw driver between the electronic brake lever and the hub.

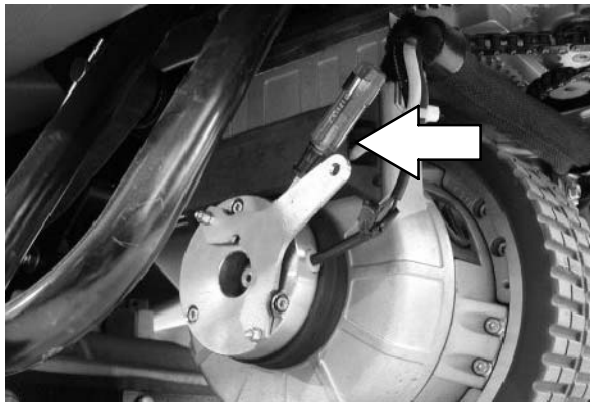

For models manufactured before serial number 10263298, the propel motor harness connector must also be disconnected.

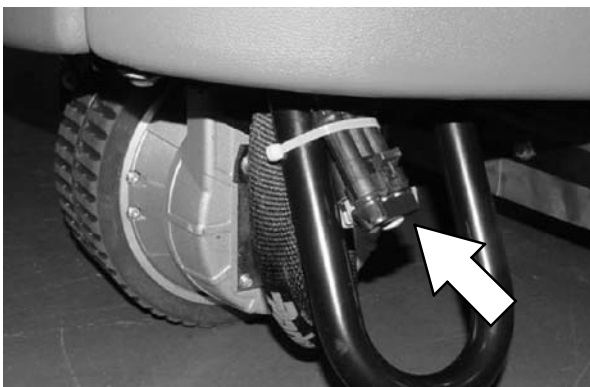

Only push or tow the machine on a level surface. Do not exceed 3.2 kp/h (2 mph). It is NOT intended to be pushed or towed at a high speed.

Immediately after pushing or towing the machine, remove the screw driver to enable the parking brake.

FOR SAFETY: Do not operate machine with the brake disabled.

TRANSPORTING THE MACHINE

When transporting the machine by trailer or truck, be certain to follow the tie-down procedure below:

1. Raise the squeegee and scrub head.
2. Load the machine using a ramp that can support the machine weight and operator. Do not operate the machine on a ramp incline that exceeds an 11 degree angle.

FOR SAFETY: When transporting machine, use a recommended ramp when loading/unloading into/off truck or trailer.

3. Position the front of machine against the front of the trailer or truck.
4. Lower the scrub head and squeegee after the machine is positioned on the trailer or truck.
5. Place a block behind each wheel to prevent the machine from rolling.
6. Route the front tie-down straps through the stabilizer arms and then secure the tie-downs to the trailer or truck to prevent the machine from tipping.

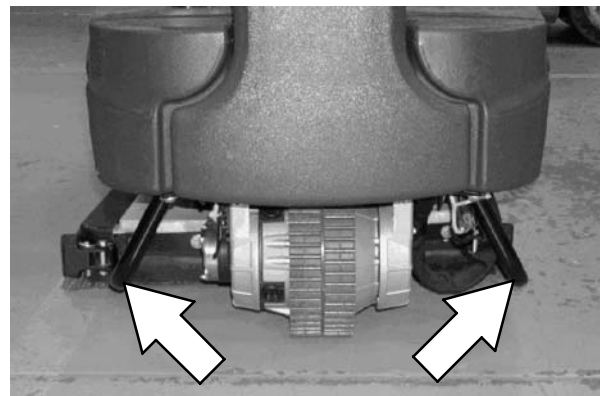

NOTE: It may be necessary to install tie-down brackets to the floor of the trailer or truck.

FOR SAFETY: When transporting machine, use tie-down straps to secure machine to truck or trailer.

7. Route the rear tie-down straps through the opening at the center part of the rear axle.

MACHINE JACKING

Empty the recovery and solution tanks before jacking the machine. Jack up the machine for service at the designated locations. Use a hoist or jack capable of supporting the weight of the machine. Always stop the machine on a flat, level surface and block the tires before jacking up the machine.

Front jacking locations are located on both sides of the machine.

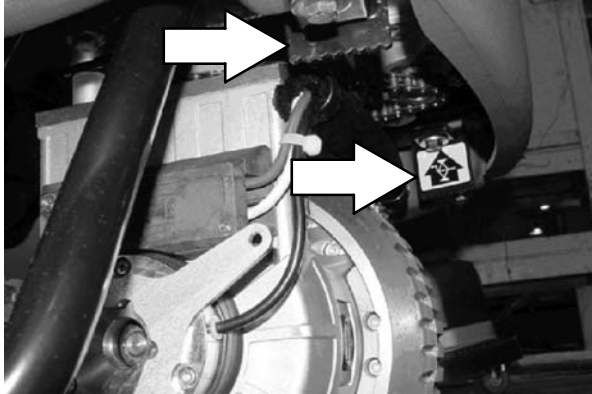

Rear jacking locations are located on both sides of the machine at the axles.

FOR SAFETY: Before leaving or servicing machine, stop on level surface.

FOR SAFETY: When servicing machine, block machine tires before jacking machine up. Use a hoist or jack that will support the weight of the machine. Jack machine up at designated locations only. Block machine up with jack stands.

STORAGE INFORMATION

The following steps should be taken when storing the machine for extended periods of time.

1. Drain and clean the solution and recovery tanks. Open the recovery tank cover to promote air circulation.
2. Park the machine in a cool, dry area. Do not expose the machine to rain. Store indoors.
3. Remove the batteries, or charge them every three months.

FREEZE PROTECTION

1. Drain the solution tank and recovery tank of all water.
2. Pour 2 gallons (8 liters) of Propylene Glycol Based / Recreational Vehicle (RV) antifreeze into the solution tank at full strength. Do not dilute.
3. FaST models: Remove the FaST-PAK and store in temperatures above freezing.

FOR SAFETY: Avoid eye contact with antifreeze. Wear safety glasses.

4. Turn the machine power on and operate the solution flow system. Turn the machine off when the antifreeze appears at the scrub head.

Continue with the freeze protection procedure if machine is equipped with the *ec-H2O* system.

***ec-H2O* Model:**

5. Press and release the flush switch on the *ec-H2O* module to cycle the antifreeze through *ec-H2O* system. When the antifreeze appears at the scrub head, press the switch again to turn off the module.

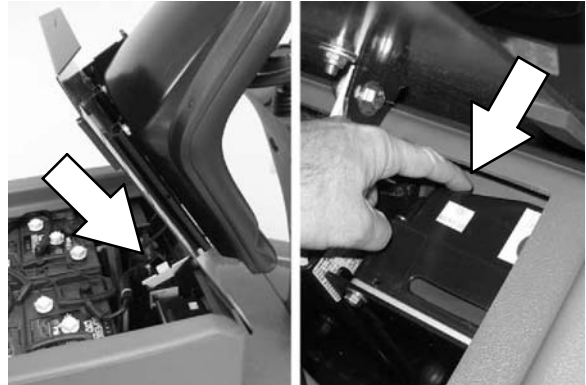

IMPORTANT: Before operating machine, the antifreeze must be flushed from the module as described below.

If the antifreeze is not properly flushed from the *ec-H2O* system, the *ec-H2O* module may detect an error and not function (*ec-H2O* switch indicator light will turn red). If this occurs, reset key and repeat the flush procedure as described below.

Flushing antifreeze from *ec-H2O* module:

1. Drain the antifreeze from the solution tank into a bucket.
2. Fill the solution tank with cool water until full (See FILLING THE SOLUTION TANK).
3. Disconnect the black connector fitting at the scrub head and place the hose into a bucket.

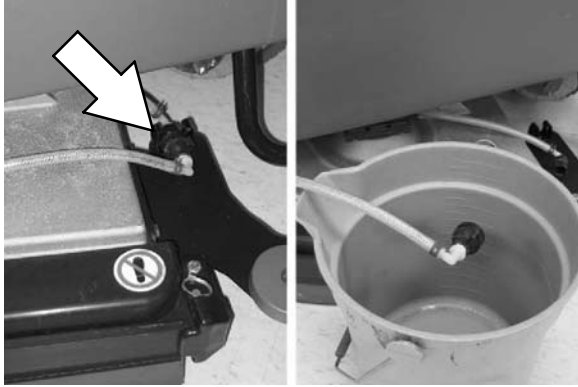

4. Press and release the *ec-H2O* module flush switch to start the flush cycle. The module is located under the seat.

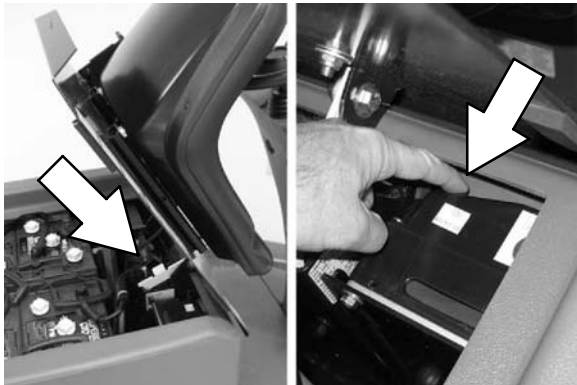

When the water turns clear, press the module switch again to stop the flush cycle.

Dispose the antifreeze in an environmentally safe way according to local waste disposal regulations.

5. The machine is now ready for scrubbing.

SPECIFICATIONS

SPECIFICATIONS

GENERAL MACHINE DIMENSIONS/CAPACITIES

Item	Disk 650 mm (26 in)	Cylindrical 700 mm (28 in)	Disk 800 mm (32 in)	Cylindrical 800 mm (32 in)
Length	1520 mm (60 in)			
Height	1270 mm (50 in)			
Width / frame	740 mm (29 in)	810 mm (31.7 in)	740 mm (29 in)	810 mm (31.7 in)
Width / machine with scrub head	800 mm (31.5 in)	830 mm (32.5 in)	910 mm (36 in)	930 mm (36.5 in)
Width / rear squeegee (roller to roller)	850 mm (33.25 in)	850 mm (33.25 in)	1000 mm (39.25 in)	1000 mm (39.25 in)
Brush diameter	330 mm (13 in)	150 mm (6 in)	410 mm (16 in)	150 mm (6 in)
Brush length	-	700 mm (28 in)	-	800 mm (32 in)
Scrubbing path width	650 mm (26 in)	700 mm (28 in)	800 mm (32 in)	800 mm (32 in)
Solution tank capacity	110 L (29 gallons)			
Recovery tank capacity	110 L (29 gallons)			
Weight/net less batteries	265 Kg (585 lbs)	287 kg (632 lbs)	265 Kg (585 lbs)	296 kg (653 lbs)
Weight/with standard battery package	386 Kg (850 lbs)	407 kg (897 lbs)	386 Kg (850 lbs)	416 kg (918 lbs)
Weight/with heavy duty battery package	443 Kg (975 lbs)	464 kg (1022 lbs)	443 Kg (975 lbs)	473 kg (1043 lbs)
GVWR	675 Kg (1485 lbs)			
Operating Sound Level At Operator Ear	67 dB(A)	69 dB(A)	67 dB(A)	69 dB(A)
Vibration level at steering wheel	0.2 m/s ²			

GENERAL MACHINE PERFORMANCE

Item	Measure
Aisle turnaround width for 650 mm (26 in) scrub head	1730 mm (68.5 in)
Aisle turnaround width for 800 mm (32 in) scrub head	1840 mm (72.5 in)
Travel Speed (maximum)	6.4 Km/h (4 mph)
Maximum rated climb and descent angle with full tanks	6°/10.5%
Maximum rated climb and descent angle with empty tanks	11°/19.25%
Maximum rated climb and descent angle when scrubbing	4°/7%

POWER TYPE

Type	Quantity	Volts	Ah Rating	Weight (Each)
Batteries (standard lead acid)	4	6	235 @ 20 hr rate	30.0 kg (66 lb)
Batteries (heavy duty aead acid)	4	6	335 @ 20 hr rate	44.5 kg (97.5 lb)
Batteries (Gel)	4	6	180 @ 20 hr rate	30.0 kg (66 lb)
Batteries (heavy duty Gel)	4	6	220 @ 20 hr rate	30.0 kg (66 lb)

Type	Use	VDC	kW (hp)
Electric Motors	Scrub brush (Disk)	24	0.45 kW (0.6 hp)
	Scrub brush (Cylindrical)	24	0.50 kW (0.75 hp)
	Vacuum fan	24	0.45 kW (0.6 hp)
	Propelling	24	0.85 kW (1.1 hp)

Type	VDC	amp	Hz	Phase	VAC
Chargers (Smart)	24	20	60	1	120
	24	25	60	1	120
Chargers (Gel/Agm)	24	20	60	1	120
	24	20	50 / 60	1	240
Chargers (On-Board)	24	25	50 / 60	1	115

TIRES

Location	Type	Size
Front (1)	Solid	90 mm wide x 260 mm OD (3.5 in wide x 10 in OD)
Rear (2)	Solid	80 mm wide x 260 mm OD (3.0 in wide x 10 in OD)

FaST SYSTEM (OPTION)

Item	Measure
Solution pump	24 Volt DC, 5A, 5.7 LPM (1.5 GPM) open flow, 70 psi bypass setting
Solution flow rate	1.1 LPM (0.30 GPM)
Detergent to water dilution ratio	1:1000
Detergent flow rate	1.35 CC/Minute (0.046 Ounces/Minute)

ec-H2O SYSTEM (OPTION)

Item	Measure
Solution pump	24 Volt DC, 5A, 5.7 LPM (1.5 GPM) open flow, 70 psi bypass setting
Solution flow rate*	1.1 L/min (0.30 gpm) Disk model
	1.5 L/min (0.40 gpm) Cylindrical brush model
	1.9 L/min (0.50 gpm) Optional

* If the optional solution flow rates are required, contact an Authorized Service Center.

SPECIFICATIONS

For 650 mm (26 in) and 700 mm (28 in) squeegee
800 mm (33.25 in)

For 800 mm (32 in) squeegee
1000 mm (39.25 in)

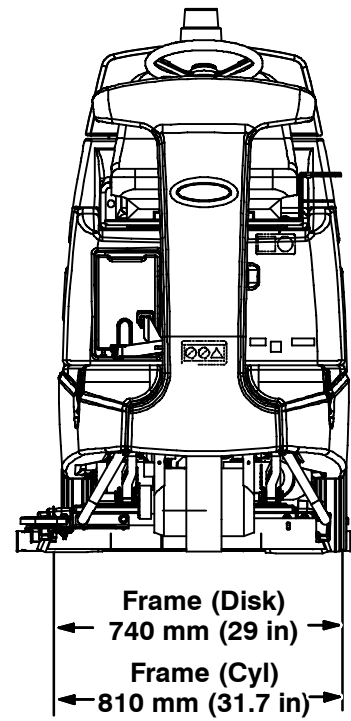
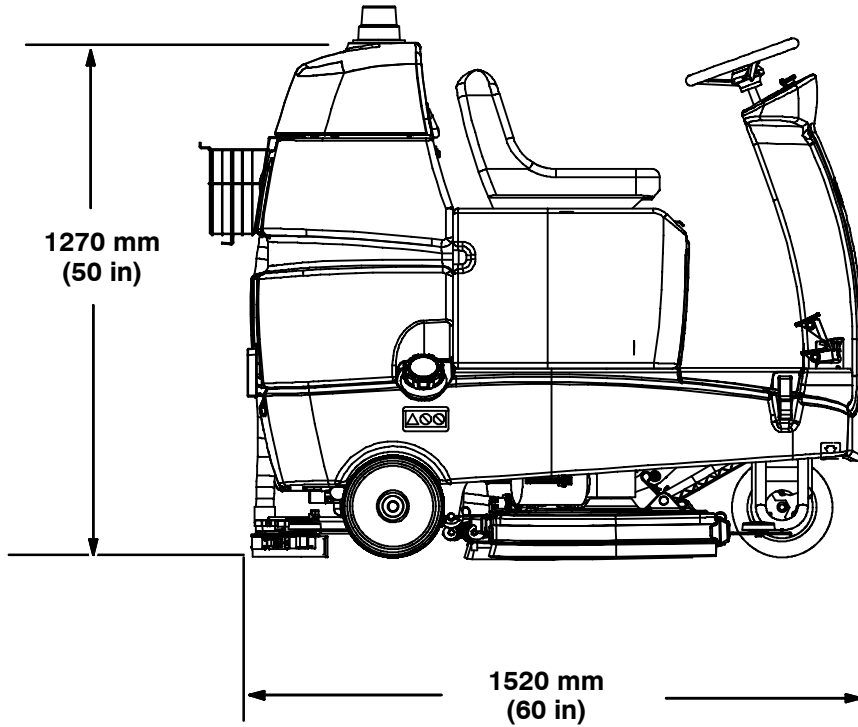
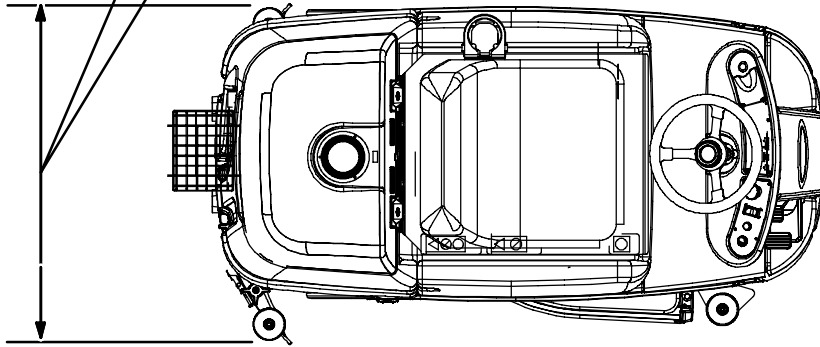

1014751

MACHINE DIMENSIONS

A

Adjusting cylindrical brush taper, 35
 Adjusting cylindrical brush width, 36
 Adjusting Rear Squeegee Blade Deflection, 41
 Adjusting the Squeegee Guide Roller, 40
 Attaching the Squeegee Assembly, 8
 Audio Alarms (Horn), 21

B

Batteries, 26
 Charging the Batteries, 27, 29
 Check Electrolyte Level, 26
 Clean Batteries, 26
 Disposing Batteries, 26
 Gel, 26
 Lead acid, 26
 Measure Specific Gravity, 26
 Specifications, 47
 Battery Charger, Error codes, 29
 Battery Discharge Indicator, 16
 Before Operating, 9
 Belts, 30
 Belts (Cylindrical Models), Inspect Belts, 30
 Brush Information, 7
 Available Scrub Head Widths, 6
 Brush pattern, Checking cylindrical , 34
 Brush taper, Adjusting cylindrical , 35
 Brush width, Adjusting cylindrical , 36
 Brush, Replacing, 31
 Brushes and Pads, 31

C

Capacities, 46
 Charger, Checking on-board charger settings, 28
 Charger error codes, 29
 Charger settings, 28
 Charging the Batteries, 27, 29
 Checking on-board charger settings, 28
 Check Electrolyte Level (Batteries), 26
 Check Specific Gravity (Batteries), 26
 Checking cylindrical brush pattern, 34
 Circuit Breakers, 18
 Clean Batteries, 26
 Contents, 1

Controls and Instruments, 5
 Conventional Scrubbing, 6
 Cylindrical brushes, 33

D

Debris tray, 9, 21
 Dimensions, 46
 Disk brushes, 31
 Disk Scrub Head Floor Skirt, 42
 Double Scrubbing, 13
 Draining and Cleaning the Tanks, 19

E

ec-H2O Scrubbing (ec-H2O Model), 7
 ec-H2O Button, 10
 ec-H2O Alarm, 14, 15
 ec-H2O System Indicator Light, 10, 15
 ec-H2O System Troubleshooting, 23
 ec-H2O System (ec-H2O Model), 37
 ec-H2O Module Flush Procedure, 37
 Economy Setting, 11
 Electric Motors, 30
 Inspect Electric Motors, 30
 Emergency Stop Button, 15
 Error codes, battery charger, 29

F

FaST Supply Hose Connector, 37
 FaST System, Specifications, 47
 FaST System Maintenance (FaST Model), FaST
 Supply Hose Connector, 37
 FaST System Maintenance (Fast Mode)
 FaST Detergent Injector Maintenance, 36
 Replacing the FaST-PAK (FaST Model), 36
 FaST-PAK (FaST Model), 8
 Fault Indicator, 17
 Filling the Solution Tank, 9
 For Conventional Scrubbing, 9
 For FaST or ec-H2O Scrubbing, 9
 Flushing ec-H2O System Module, 37
 Foam Scrubbing System (Fast Mode), 6
 Freeze protection, 44
 ec-H2O System, 44
 Fuses, 18

G

Gel Batteries, 26

H

Hazard Light Switch (Option), 18

Hour Meter, 15

How the Machine Works, 6

I

Indicators, 15

 Battery Discharge Indicator, 16

 Fault Indicator, 17

 Recovery Tank Full Indicator, 15

 Solution Tank Empty Indicator, 15

Installing brushes/pads, 8

Installing the FaST-PAK (FaST Model), 8

L

Labels, 3

Lead Acid Batteries, 26

Leveling the Rear Squeegee, 40

M

Machine components, 4

Machine Dimensions, 48

Machine Jacking, 44

Machine Operation, 9

 Battery Discharge Indicator, 16

 Before Operating, 9

 Circuit Breakers, 18

 Double Scrubbing, 13

 ec-H₂O System indicator Light, 15

 Emergency Stop Button, 15

 Fault Indicator, 17

 Fuses, 18

 Hazard Light Switch (Option), 18

 Hour Meter, 15

 Pre-Operation Checklist, 9

 Recovery Tank Full Indicator, 15

 Scrubbing, 11

 Setting Scrub Modes, 10

 Economy Setting, 11

 Setting Brush Pressure, 10

 Setting ec-H₂O Button, 10

 Setting FaST Button, 10

 Setting Solution Flow (Conventional Scrubbing Only), 10

 Solution Tank Empty Indicator, 15

 Water Pickup Mode (No Scrubbing), 14

 While Operating the Machine, 14

Machine Performance

 Aisle Turnaround width, 46

 Climb and Descent Angles, 46

 Travel Speed (Maximum), 46

Machine Setup, 8

 Attaching Squeegee Assembly, 8

 Filling the Solution Tank, 9

 For Conventional Scrubbing, 9

 For FaST or ec-H₂O Scrubbing, 9

Machine Specifications, 46 - 49

Machine Troubleshooting, 22

Maintenance, 24 - 48

 Adjusting cylindrical brush taper, 35 - 40

 Adjusting cylindrical brush width, 36 - 41

 Checking cylindrical brush pattern, 34 - 39

 Cylindrical brushes, 33 - 38

 Disk brushes, 31 - 36

 Replacing or rotating cylindrical brushes, 33 - 38

Maintenance Chart, 25

O

Off-board charger, 27

On-board charger, 29

Operating Sound Level, 46

Operation, 4 - 28

Options, FaST System Specifications, 47

P

Pad Driver, Replacing, 31

Pad, Replace, 32

Pads, Scrub, 7, 31

Pre-Operation Checklist, 9

Propel System Troubleshooting, 21

Pushing or Towing the Machine, 43

Pushing, Towing, and Transporting the Machine, 43

 Pushing or Towing the Machine, 43

 Transporting the Machine, 43

R

Rear Squeegee Blade, 38
 Adjusting Rear Squeegee Deflection, 41
 Leveling the Rear Squeegee, 40
 Replacing (or Rotating) the Rear Squeegee Blade, 38

Rear Squeegee Blade, Adjusting the Squeegee Guide Roller, 40

Recovery Tank Full Indicator, 15

Recovery Tank Seal, 42

Replacing (or Rotating) the Rear Squeegee Blades, 38

Replacing Disk Brushes or Pad Driver, 31

Replacing disk pads, 32

Replacing or rotating cylindrical brushes, 33

Replacing the Side Squeegee Blades, 40

Rotating cylindrical brushes, 33

S

Safety
 Labels, 3
 Precautions, 2

Screen, FaST System Filter Screen, 36

Scrub brushes
 Adjusting cylindrical brush taper, 35
 Adjusting cylindrical brush width, 36
 Checking cylindrical brush pattern, 34
 Cylindrical brushes, 33

Scrub Brushes and Pads, 31
 Disk brushes, 31
 Replacing Scrub Pads, 32

Scrub Brushes, Replacing, 31

Scrub Pads, 7

Scrubbing, 11

Setting Brush Pressure, 10

Setting FaST Button, 10

Setting ec-H₂O Button, 10

Setting Scrub Modes, 10

Setting Solution Flow (Conventional Scrubbing Only), 10

Side Squeegee Blades, 40
 Replacing Side Squeegee Blades, 40

Skirts and Seals, 42
 Disk Scrub Head Floor Skirt, 42
 Recovery Tank Seal, 42
 Solution Tank Seals, 42

Solution Tank Empty Indicator, 15

Solution Tank Seals, 42

Specifications, 46 – 49
 Battery Chargers, 47
 Electric Motors, 47
 FaST System, 47
 Machine Capacities, 46
 Machine Dimensions, 46
 Machine Performance, 46
 Operating Sound Level, 46
 Power Type, 47
 Tires, 47

Squeegee Blades, 38
 Adjusting the Rear Squeegee Blade Deflection, 41
 Adjusting the Squeegee Guide Roller, 40
 Leveling the Rear Squeegee, 40
 Replacing (or Rotating) the Rear Squeegee Blades, 38
 Replacing Side Squeegee Blades, 40

Squeegee, Attaching, 38
 Rear Squeegee, 38
 Side Squeegee, 40

Storage Information, 44
 Freeze protection, 44
 Storing the Machine, 44

T

Tires, 42
 Specifications, 47

Transporting the Machine, 43

W

Water Pickup Mode (No Scrubbing), 14

While Operating the Machine, 14