



Electronic Service Manuals

This electronic document is provided as a service to our customers. We do not create the contents of the information contained in this document. Should you have detailed questions pertaining to the information contained in this document, you may contact Michco, or the manufacturer which provided the original information in this electronic deliverable. Michco's only part in this electronic deliverable was the electronic assembly process. By providing this manual on line we are not guaranteeing parts availability.

You may contact Michco through the following methods:

Phone (517) 484-9312 or (800) 331-3339

2011 N. High St. -- Lansing, Michigan -- 48906

Fax: (517) 484-9836

Email: CustServe@Michco.com

Web site: www.Michco.Com

Parts Web site: www.FloorMachineParts.Com

Order Parts on Line at:

www.FloorMachineParts.Com

Directly to Parts & Service:

By Email: **Shop@Michco.com**

By Fax: (517) 702-2041

By Voice: Use numbers above.

Serving the Cleaning Industry Since 1922

Notice: All copyrighted material remains property of original owners, all trademarks are property of respective owners. Manuals are subject to Manufacturer's reproduction limitations. Originals or reproductions were provided by manufacturers through a request. We make no warranty as to the correctness of information provided in this document and you assume all risk. By placing these manuals on line we are not declaring our corporation to be an manufacturer authorized dealer or provider, please check our web site for authorized manufacturers we represent.



6100

(Electric)

Rider Sweeper Operator Manual

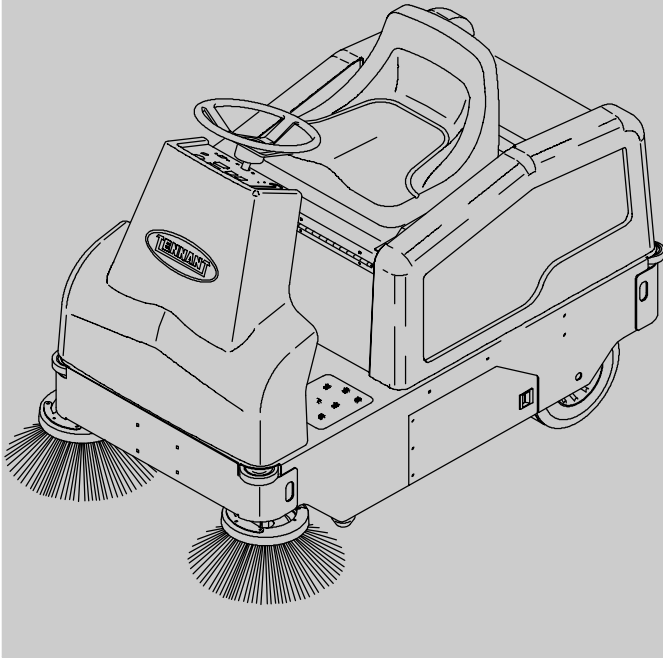

North America / International

www.tennantco.com

330250
Rev. 10 (08-2008)





This manual is furnished with each new model. It provides necessary operation and maintenance instructions.

Read this manual completely and understand the machine before operating or servicing it.

This machine will provide excellent service. However, the best results will be obtained at minimum costs if:

- The machine is operated with reasonable care.
- The machine is maintained regularly - per the machine maintenance instructions provided.
- The machine is maintained with manufacturer supplied or equivalent parts.

	PROTECT THE ENVIRONMENT Please dispose of packaging materials, old machine components such as batteries, hazardous fluids including antifreeze and oil, in an environmentally safe way according to local waste disposal regulations.
	Always remember to recycle.

MACHINE DATA	
Please fill out at time of installation for future reference.	
Model No. -	_____
Serial No. -	_____
Machine Options -	_____
Sales Rep. -	_____
Sales Rep. phone no. -	_____
Customer Number -	_____
Installation Date -	_____

Tennant Company
PO Box 1452
Minneapolis, MN 55440
Phone: (800) 553-8033 or (763) 513-2850
www.tennantco.com

InstantAccess, Quick Mop, and VCS are US registered and unregistered trademarks of Tennant Company.

Specifications and parts are subject to change without notice.

Original instructions, Copyright © 1998-2002, 2004, 2005, 2007, 2008 TENNANT Company, Printed in U.S.A.

CONTENTS

	Page		Page
SAFETY PRECAUTIONS	3	STEERING CASTOR PIVOT BEARING	
OPERATION	5	(For machines below serial	
OPERATOR RESPONSIBILITY	5	number 002363)	41
MACHINE COMPONENTS	6	STEERING CASTER PIVOT BEARING	
SYMBOL DEFINITIONS	7	(For machines serial number 002363	
CONTROLS AND INSTRUMENTS	8	and above)	41
OPERATION OF CONTROLS	9	BATTERIES	42
DIRECTIONAL PEDAL	9	CHARGING THE BATTERIES	43
BRAKE PEDAL	10	ELECTRIC MOTORS	46
PARKING BRAKE PEDAL	10	BELTS AND CHAINS	46
LARGE DEBRIS TRAP PEDAL	10	VACUUM FAN BELT	46
MAIN BRUSH LEVER	11	MAIN BRUSH BELT	46
MAIN BRUSH, VACUUM FAN AND		PROPELLING CHAIN (For machines below	
FILTER SHAKER SWITCH	11	serial number 002363)	46
POWER KILL SWITCH	11	STEERING GEAR CHAIN (For machines	
BATTERY DISCHARGE INDICATOR ..	12	below serial number 002363)	47
STEERING WHEEL	12	STEERING GEAR CHAIN (For machines	
HOURLMETER	12	serial number 002363 and above) ...	47
ON-OFF KEY SWITCH	13	STATIC DRAG CHAIN	47
HORN BUTTON	13	DEBRIS HOPPER	48
SIDE BRUSH LEVER	13	INSTANT ACCESS HOPPER FILTER ..	48
OPERATING LIGHTS SWITCH		REMOVING INSTANT ACCESS	
(OPTION)	14	FILTER	49
OPERATING/HAZARD LIGHTS SWITCH		BRUSHES	54
(OPTION)	14	MAIN BRUSH	54
FUSES	15	REPLACING MAIN BRUSH	54
CIRCUIT BREAKERS	15	CHECKING AND ADJUSTING MAIN	
OPERATOR SEAT	16	BRUSH PATTERN	55
ADJUSTABLE OPERATOR SEAT		SIDE BRUSH	57
(OPTION)	16	REPLACING SIDE BRUSH	58
OPERATOR SAFETY SWITCH	16	SIDE BRUSH GUARD	58
HOPPER	17	SKIRTS AND SEALS	59
HOW THE MACHINE WORKS	18	REAR SKIRT	59
PRE-OPERATION CHECKLIST	18	SIDE SKIRTS	59
STARTING THE MACHINE	19	LARGE DEBRIS TRAP SKIRT	60
OPERATION ON INCLINES	20	HOPPER SEALS	60
SWEEPING AND BRUSH		BRAKES AND TIRES	61
INFORMATION	21	BRAKES (For machines below serial	
SWEEPING	23	number 002363)	61
STOP SWEEPING	25	BRAKES (For machines serial number	
STOPPING THE MACHINE	26	002363 and above)	62
EMPTYING THE HOPPER	27	TIRES	63
POST-OPERATION CHECKLIST	28	PUSHING, TOWING, AND TRANSPORTING	
OPTIONS	29	THE MACHINE	64
VACUUM WAND	29	PUSHING OR TOWING THE MACHINE	64
QUICK MOP	31	TRANSPORTING THE MACHINE	64
ROLLOUT BATTERY	33	MACHINE JACKING	67
MACHINE TROUBLESHOOTING	37	STORING MACHINE	67
MAINTENANCE	38		
MAINTENANCE CHART	38		
LUBRICATION	40		
PROPELLING SYSTEM (For machines			
below serial number 002363)	40		
STEERING GEAR CHAIN (For machines			
below serial number 002363)	40		
STEERING GEAR CHAIN (For machines			
serial number 002363 and above) ...	40		

CONTENTS

	Page
SPECIFICATIONS	68
GENERAL MACHINE	
DIMENSIONS/CAPACITIES	68
GENERAL MACHINE PERFORMANCE ...	68
POWER TYPE	69
STEERING	69
BRAKING SYSTEM	69
TIRES	69
MACHINE DIMENSIONS	70
INDEX	71

SAFETY PRECAUTIONS

The following symbols are used throughout this manual as indicated in their description:



WARNING: To warn of hazards or unsafe practices that could result in severe personal injury or death.

FOR SAFETY: To identify actions that must be followed for safe operation of equipment.

The machine is suited to sweep disposable debris. Do not use the machine other than described in this Operator Manual. The machine is not designed for use on public roads.

The following information signals potentially dangerous conditions to the operator or equipment:



WARNING: Batteries emit hydrogen gas. Explosion or fire can result. Keep sparks and open flame away. Keep covers open when charging.



WARNING: Brush throws debris. Stop motor before lifting hopper.

FOR SAFETY:

1. **Do not operate machine:**
 - Unless trained and authorized.
 - Unless operation manual is read and understood.
 - In flammable or explosive areas unless designed for use in those areas.
 - In areas with possible falling objects unless equipped with overhead guard.
2. **Before starting machine:**
 - Make sure all safety devices are in place and operate properly.
 - Check brakes and steering for proper operation.
3. **When starting machine:**
 - Keep foot on brake and directional pedal in neutral.
4. **When using machine:**
 - Do not pick up burning or smoking debris, such as cigarettes, matches or hot ashes.
 - Use brakes to stop machine.
 - Go slowly on inclines and slippery surfaces.
 - Use care when reversing machine.
 - Do not carry riders on machine.
 - Always follow safety and traffic rules.
 - Report machine damage or faulty operation immediately.
5. **Before leaving or servicing machine:**
 - Stop on level surface.
 - Set parking brake.
 - Turn off machine and remove key.
6. **When servicing machine:**
 - Avoid moving parts. Do not wear loose jackets, shirts, or sleeves when working on machine.
 - Block machine tires before jacking up machine.
 - Jack up machine at designated locations only. Block machine up with jack stands.
 - Use hoist or jack that will support the weight of the machine.
 - Wear eye and ear protection if using pressurized air or water.
 - Disconnect battery connections before working on machine.
 - Avoid contact with battery acid.
 - Use cardboard to locate leaking hydraulic fluid under pressure.
 - Use Tennant supplied or equivalent replacement parts.
7. **When loading/unloading machine onto/off truck or trailer:**
 - Turn off machine.
 - Use truck or trailer that will support the weight of the machine.
 - Use winch. Do not drive the machine onto/off the truck or trailer unless the load height is 380 mm (15 in) or less from the ground.
 - Set parking brake after machine is loaded.
 - Block machine tires.
 - Tie machine down to truck or trailer.

SAFETY PRECAUTIONS

The following safety labels are mounted on the machine in the locations indicated. If these or any labels become damaged or illegible, install a new label in its place.

FOR SAFETY LABEL - LOCATED ON THE SIDE OF THE OPERATOR COMPARTMENT.

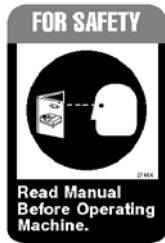

FLYING DEBRIS LABEL - LOCATED ABOVE HOPPER.

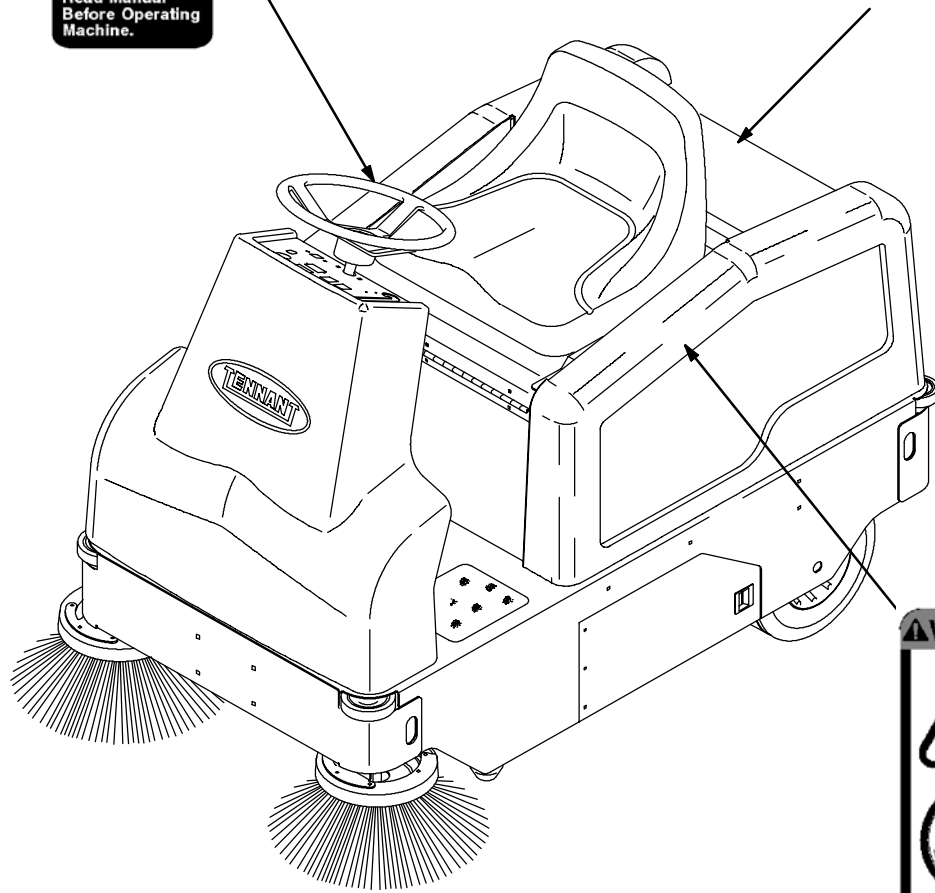

BATTERY CHARGING LABEL - LOCATED IN BATTERY COMPARTMENT.

OPERATION

OPERATOR RESPONSIBILITY

- The operator's responsibility is to take care of the daily maintenance and checkups of the machine to keep it in good working condition. The operator must inform the service mechanic or supervisor when the maintenance intervals are required as stated in the *MAINTENANCE* section of this manual.
- Read this manual carefully before operating the machine. View the operation video supplied with the machine.

FOR SAFETY: Do not operate machine, unless operation manual is read and understood.

- Check the machine for shipping damage. Check to make sure the machine is complete per shipping instructions.
- Keep your machine regularly maintained by following the maintenance information in this manual. We recommend taking advantage of a regularly scheduled service contract from your Tennant representative.
- Order parts and supplies directly from your authorized Tennant representative. Use the parts manual provided when ordering parts.
- After operation, follow the recommended daily and hourly procedures stated in the *MAINTENANCE CHART*.

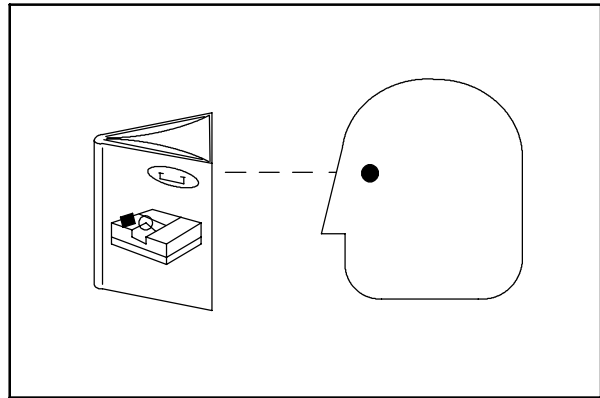

07324





















MACHINE COMPONENTS



- A. Instrument panel
- B. Steering wheel
- C. Operator pedals
- D. Operator seat
- E. Batteries
- F. Hopper
- G. Instant Access filter
- H. Brush door

SYMBOL DEFINITIONS

These symbols identify controls, displays, and features on the machine:

	On		Operating lights
	Off		Hazard light
	Main brush down		Start
	Main brush up		Vacuum Fan
	Circuit breaker #1		Main brush on
	Circuit breaker #2		Filter shaker
	Circuit breaker #3		Side brush down and on
	Circuit breaker #4		Side brush up and off
	Circuit breaker #5		Horn
	Circuit breaker #6		Battery charging system

OPERATION

CONTROLS AND INSTRUMENTS

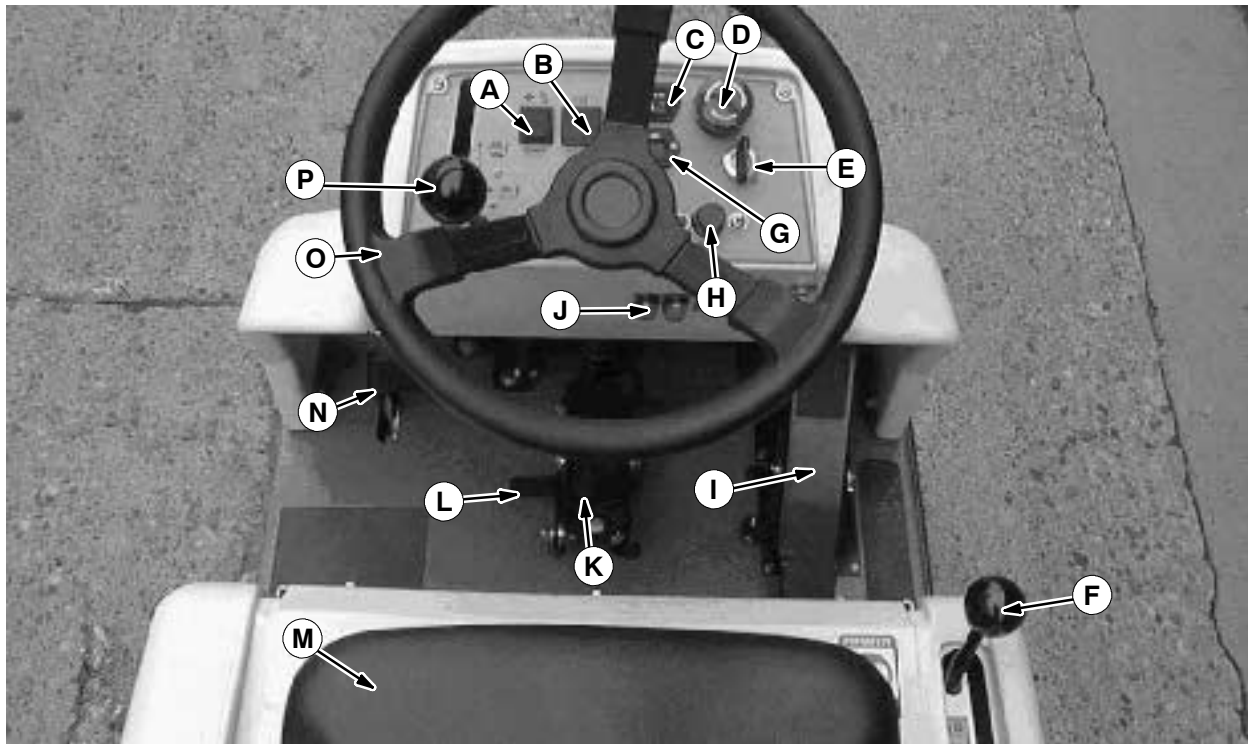

- A. Main brush, vacuum fan and filter shaker switch
- B. Operating/Hazard light switch (option)
- C. Hourmeter
- D. Power kill switch
- E. On/Off key switch
- F. Main brush lever
- G. Battery discharge indicator
- H. Horn button
- I. Directional pedal
- J. Circuit breaker panel
- K. Brake pedal
- L. Parking brake pedal
- M. Operator's seat
- N. Large debris trap pedal
- O. Steering wheel
- P. Side brush lever

OPERATION OF CONTROLS

DIRECTIONAL PEDAL

The *directional pedal* controls the direction of travel and the propelling speed of the machine. Change the speed of the machine with the pressure of your foot on the pedal; the harder you press the faster the machine travels.

Use the brake pedal to stop the machine.

Forward: Press the top of the directional pedal with the toe of your foot.

NOTE: The machine will not travel unless the operator is sitting in the operator's seat.



Reverse: Press the bottom of the directional pedal with the heel of your foot.



Neutral: Take your foot off the directional pedal and it will return to the **Neutral** position.

NOTE: The machine may coast when the foot is taken off the directional pedal. Be prepared to step on the brake pedal when removing foot from directional pedal.



OPERATION

BRAKE PEDAL

The *brake pedal* stops the machine.

Stop: Remove your foot from the directional pedal and let it return to the **Neutral** position. Step on the brake pedal to prevent the machine from rolling.

NOTE: Machine may roll a slight distance when turned off. Keep foot on brake until machine stops moving.

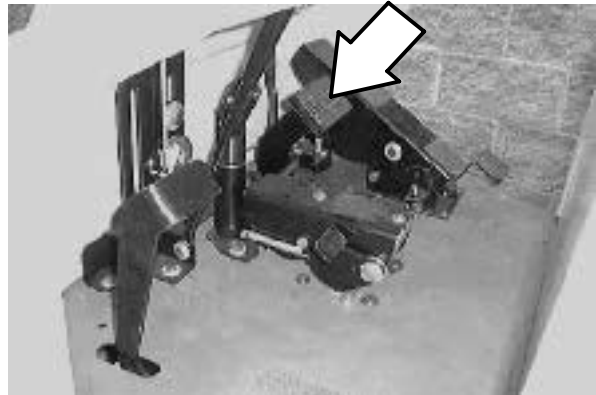

PARKING BRAKE PEDAL

The *parking brake pedal* sets and releases the front wheel brake.

Set: Hold the brake pedal with the right foot. Press on the parking brake pedal with the left foot to lock the parking brake pedal in place.

FOR SAFETY: Before leaving or servicing machine, stop on level surface, set parking brake, turn off machine, and remove key.

Release: Press down on the brake pedal until the parking brake releases.



LARGE DEBRIS TRAP PEDAL

The *large debris trap pedal* opens the trap flap in front of the main sweeping brush.

Open: Press on the trap pedal when sweeping up larger debris. The flap in front of the main sweeping brush will open.

Close: Release the pedal and the flap will close, trapping larger debris into the hopper.



MAIN BRUSH LEVER

The *main brush lever* controls the position of the main brush.

Main brush down: Pull the lever to the right and back into the **Main brush down** position.

Main brush up: Push the lever up and to the left into the **Main brush up** position.



MAIN BRUSH, VACUUM FAN AND FILTER SHAKER SWITCH

The *main brush, vacuum fan and filter shaker switch* controls the vacuum fan, rotation of the main brush and the VCS *Vibrating Comb Shaker* system filter shaker.

Vacuum and main brush on: Press the top of the switch to the **Main brush and vacuum fan on** position.

Vacuum and main brush off: Press the switch to the middle off position.

Activate VCS system filter shaker: Press the bottom of the switch and hold it for eight to ten seconds.



 **WARNING: Brush throws debris. Stop motor before lifting hopper.**

POWER KILL SWITCH

The *power kill switch* halts all power to the machine.

Halt: Push the power kill switch in.

Restart: Turn off the machine power. Turn the power kill switch to the right to release the switch. Turn on the machine power.



OPERATION

BATTERY DISCHARGE INDICATOR

The *battery discharge indicator* shows the charge level of the batteries. It displays the charge level when the machine is operating.

When the batteries are fully charged, the indicator on the far right is lit. As the batteries discharge, the indicator will move along the display to the left. Recharge the batteries when the indicator flashes.

NOTE: The reading on the battery discharge indicator is not accurate when the machine is first powered on. Operate the machine a few minutes before reading the charge level of the batteries.

NOTE: The battery discharge indicator will not reset from the flashing indicator unless the batteries have been fully charged.

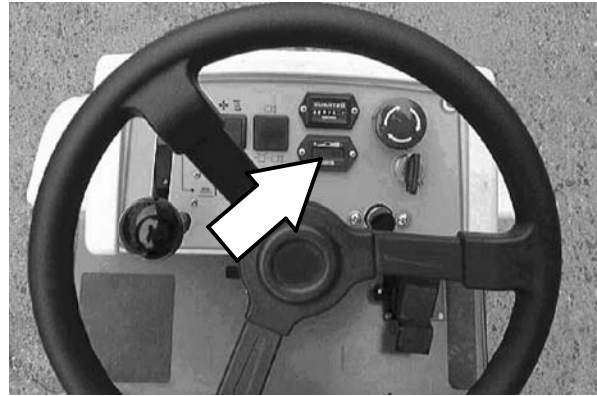

STEERING WHEEL

The *steering wheel* controls the machine's direction. The machine is very responsive to the steering wheel movements.

Left: Turn the steering wheel to the left.

Right: Turn the steering wheel to the right.

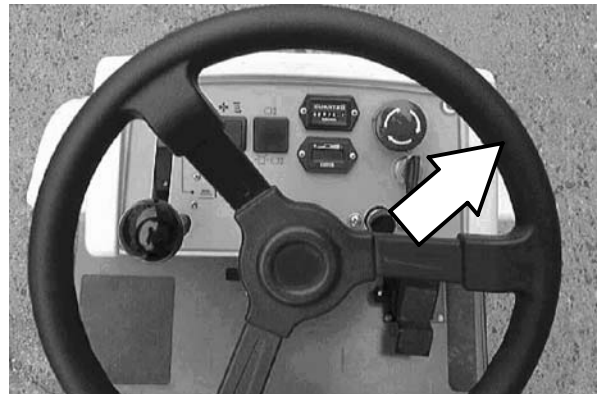

HOURMETER

The *hourmeter* records the number of hours the machine has been operated. The hourmeter displays the number of hours in tenths of an hour. Use this information to determine machine maintenance intervals.

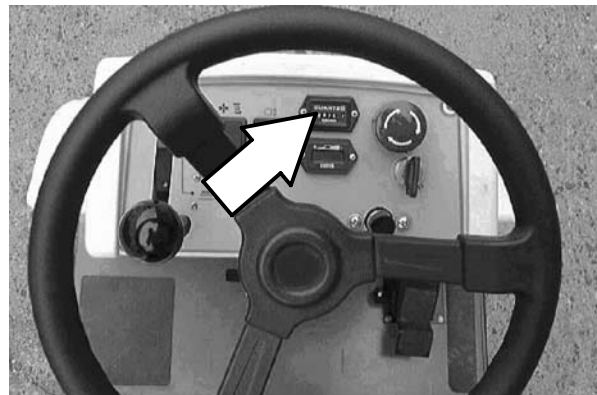

ON-OFF KEY SWITCH

The *on-off key switch* controls machine power with a key.

On: Turn the key clockwise all the way.

Off: Turn the key counterclockwise.

NOTE: The machine will not travel unless the operator is sitting in the operator's seat.

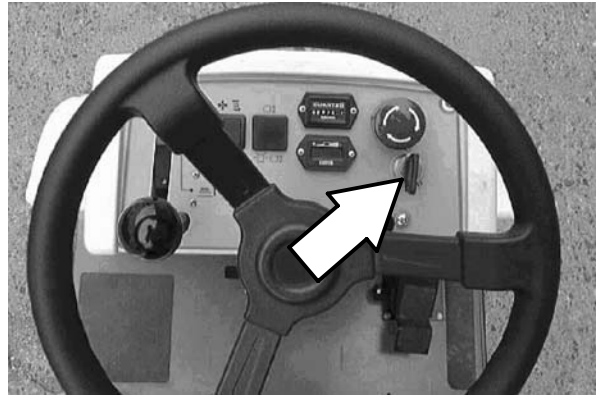

HORN BUTTON

The *horn button* operates the horn.

Sound: Press the button.

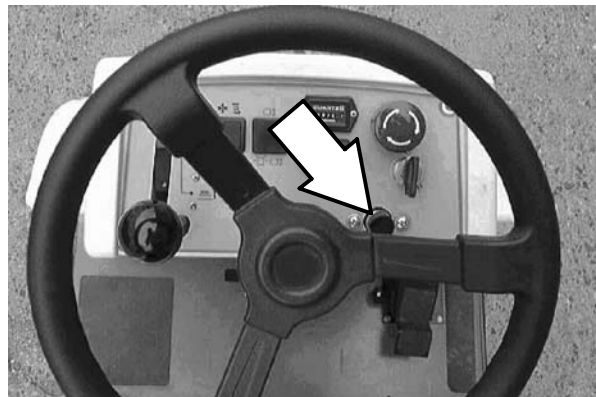

SIDE BRUSH LEVER

The *side brush lever* controls the position and the power of the side brush.

Side brush down and on: Pull the lever left and forward into the **Side brush down and on** position. The brush will automatically start rotating.

Side brush up and off: Pull the lever back and to the right into the **Side brush up and off** position.

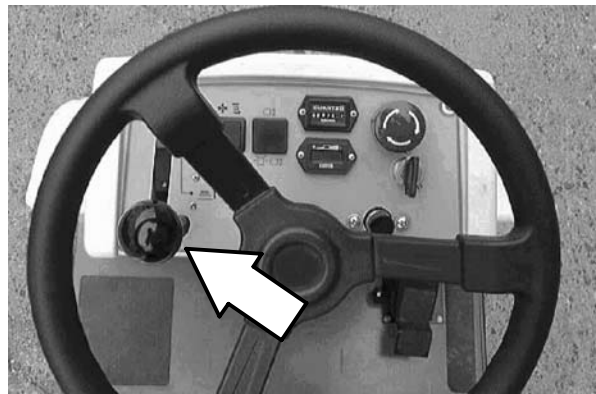

OPERATION

OPERATING LIGHTS SWITCH (OPTION)

The *operating lights switch* powers on and off the headlights and taillights option.

On: Press the top of the operating lights switch.

Off: Press the switch to the middle position.



OPERATING/HAZARD LIGHTS SWITCH (OPTION)

The *operating/hazard lights switch* powers on and off the headlights and taillights option and the hazard light option.

Operating lights on: Press the top of the operating/hazard lights switch.

Operating/Hazard lights on: Press the bottom of the operating/hazard lights switch.

Off: Press the operating/hazard lights switch in the middle position.



FUSES

Fuses are one-time protection devices designed to stop the flow of current in the event of a circuit overload. Never substitute higher value fuses than specified.

The fuse is located in the control box.

Fuse	Rating	Circuit Protected
FU-1	40 A	Main

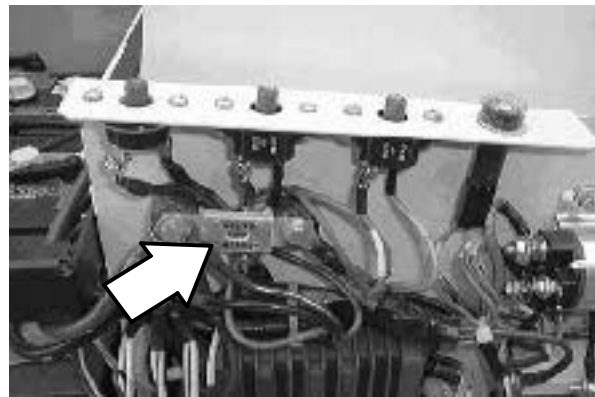

CIRCUIT BREAKERS

The *circuit breakers* are resettable electrical circuit protection devices. Their design stops the flow of current in the event of a circuit overload. Once a circuit breaker is tripped, it must be reset manually. Press the reset button after the breaker has cooled down. The circuit breakers will not reset until they have had a chance to cool down.

If the overload that caused the circuit breaker to trip is still there, the circuit breaker will continue to stop current flow until the problem is corrected.

Circuit breakers 1 through 6 are located above the foot pedals. Numbers 7 through 10 are located back under the left side panel.

The chart lists the circuit breakers and the electrical components they protect.

Circuit Breaker	Rating	Circuit Protected
CB-1	5 A	Main Power
CB-2	5 A	Main Power
CB-3	10 A	Sweeping
CB-4	10 A	Horn / Vac Wand
CB-5	15 A	Back Alarm / Lights
CB-6	15 A	Option
CB-7	10 A	Side Brush
CB-8	25 A	Main Brush
CB-9	25 A	Vac Fan Motor
CB-10	25 A	Vac Wand (Option)
CB-10	40 A	Dual Motor, Vac Wand (Option)

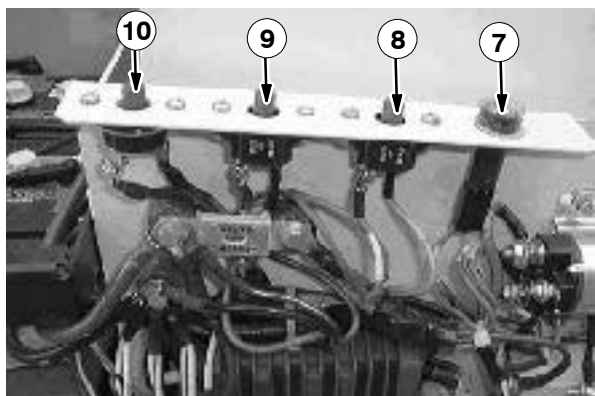
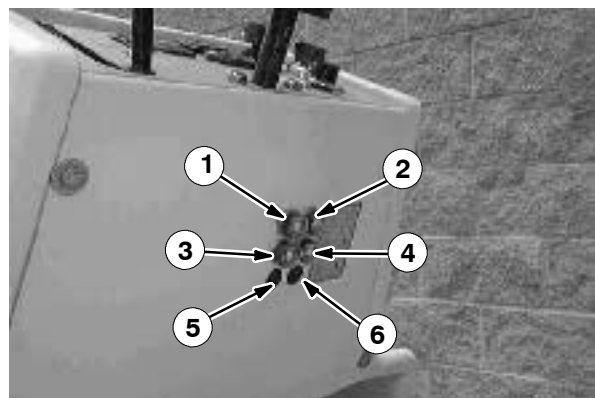

OPERATION

OPERATOR SEAT

The *operator seat* is a stationary fixed back style.



ADJUSTABLE OPERATOR SEAT (OPTION)

This *operator seat* is a fixed back style with a forward-backward adjustment.

Adjust: Pull the lever in, slide the seat backward or forward to the desired position, and release the lever to lock the seat in place.



OPERATOR SAFETY SWITCH

The operator seat has a safety switch that stops the machine from propelling unless the operator is sitting in the operator's seat.



HOPPER

The *hopper* is located in the rear of the machine under the battery compartment. The hopper rolls in and out of position and rests in grooves that hold the hopper in place.



The hopper is held in operating position with a retaining clip.

NOTE: Check that the hopper retaining clip is securely in place each time before operating machine.



OPERATION

HOW THE MACHINE WORKS

The steering wheel controls the direction of machine travel. The directional pedal controls the speed and forward/reverse direction. The brake pedal slows and stops the machine.

The side brush sweeps debris into the path of the main sweeping brush. The main brush sweeps debris from the floor into the hopper. The large debris trap pedal opens and closes the large debris trap, kicking large debris into the hopper. The vacuum system pulls dust and air into the hopper through the Instant Access filter.

When sweeping is finished, clean the Instant Access filter and empty the hopper.



PRE-OPERATION CHECKLIST

- Check the hydraulic fluid level. (if applicable)
- Check the battery fluid and charge level.
- Check the skirts and seals for damage and wear.
- Check the condition of the sweeping brushes. Remove any string, banding, plastic wrap, or other debris wrapped around them.
- Check the sweeping brush patterns for adjustment.
- Check the condition of the hopper dust filter and seals. Clean as required.
- Check the brakes and steering for proper operation.
- Empty the debris hopper.
- Check the service records to determine maintenance requirements.

STARTING THE MACHINE

1. Sit in the operator's seat and engage the brakes with the directional pedal in neutral.

FOR SAFETY: When starting machine, keep foot on brake and directional pedal in neutral.

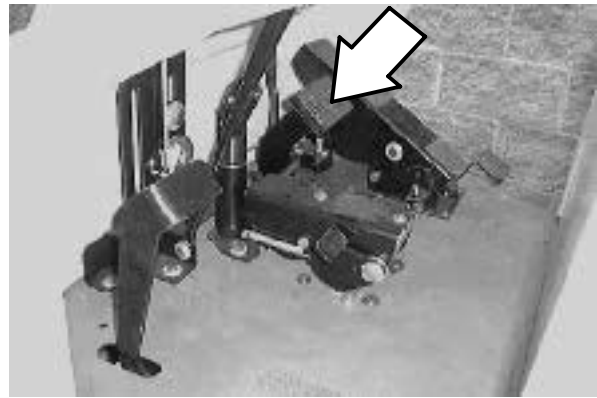

2. Turn the machine power on.



3. Release the machine parking brake.

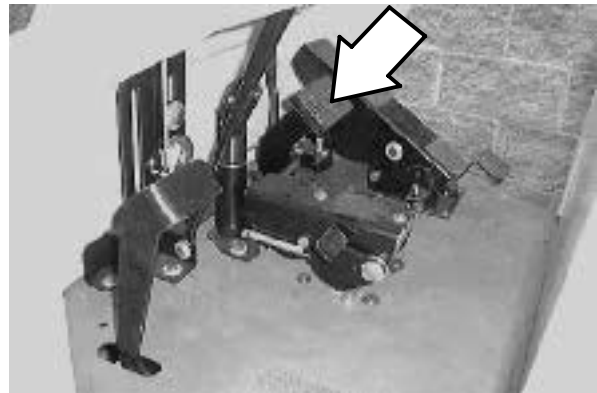

4. Drive the machine to the area to be cleaned.

NOTE: The machine will not travel unless the operator is sitting in the operator's seat.

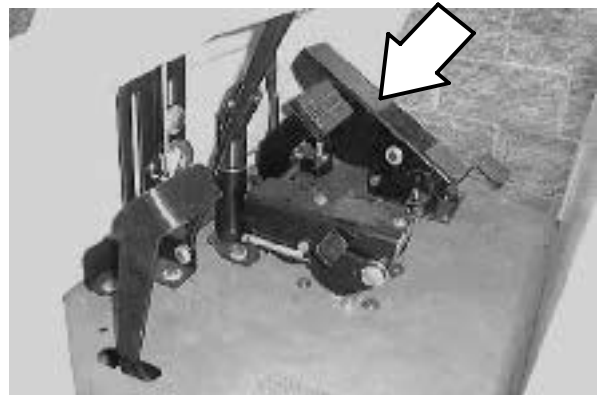

OPERATION ON INCLINES

Drive the machine slowly on inclines. Use the brake pedal to control machine speed when descending inclines.

The maximum rated incline is 8° with a full hopper and 10° with an empty hopper.

FOR SAFETY: When using machine, go slowly on inclines and slippery surfaces.

SWEeping AND BRUSH INFORMATION

Pick up oversized debris before sweeping. Flatten or remove bulky cartons from aisles before sweeping. Pick up pieces of wire, twine, string, etc., which could become entangled in the brush or brush plugs.

Plan the sweeping in advance. Try to arrange long runs with minimum stopping and starting. Do an entire floor or section at one time. Drive the straightest path possible. Avoid bumping into posts or scraping the sides of the machine. Overlap the brush paths.

Avoid turning the steering wheel too sharply when the machine is in motion. The machine is very responsive to the movement of the steering wheel. Avoid sudden turns, except in emergencies.

For best results, use the correct brush type for your sweeping application. The following are recommendations for main sweeping and side brush applications.

Polypropylene 8-single row main brush -

Superior pick-up of sand, gravel, and paper litter. Polypropylene retains its stiffness when wet and can be used indoors or outdoors with equal performance. Not recommended for high-temperature debris.

Natural Fiber main brush - The natural choice for cleaning fine debris on carpet and sweeping very heavy dust and other fine particles on hard surfaces. When cleaning carpet, check brush and perma filter panel regularly for carpet debris.

Sand wedge main brush - A fine brush that handles large quantities of dust and sand with ease.

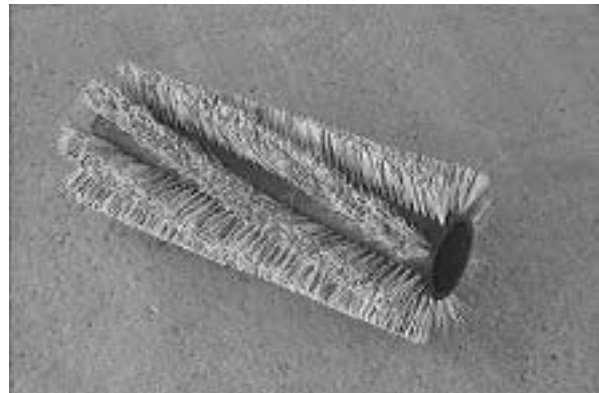

OPERATION

Side Brush (2 Row) - A good general purpose brush for sweeping of light to medium debris in both indoor and outdoor applications. This brush is recommended when bristles may get wet.

Side Brush (3 Row) - Improved sweeping performance of fine materials on smooth indoor surfaces.

Stiff Side Brush - A longer life, general purpose brush that is recommended for rough surfaces.



SWEEPING

1. Push the Main brush, vacuum fan and filter shaker switch to the **Main brush, vacuum fan on** position.



2. Lower the main brush with the main brush lever.

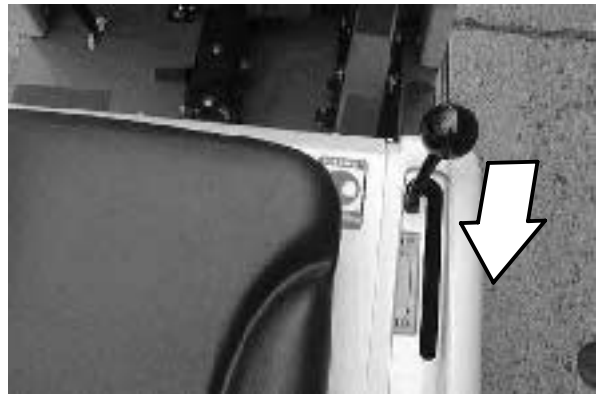

3. Lower and start the side brush with the side brush lever.



OPERATION

4. Begin sweeping.
5. Press down on the large debris trap pedal when sweeping **large debris**.



6. Release the pedal, and the flap will lower over the debris.
7. The flap will trap large debris back into the hopper.

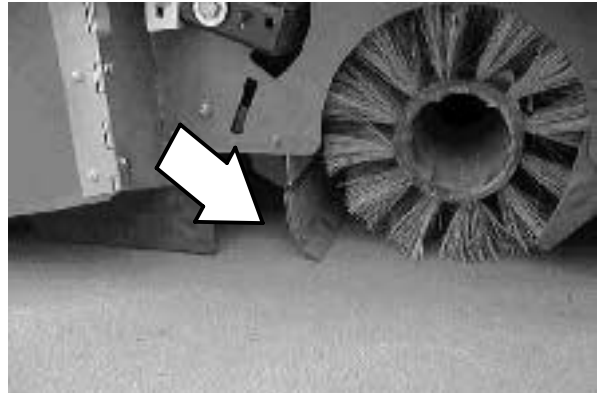

STOP SWEEPING

1. Raise and stop the side brush with the side brush lever.



2. Raise the main brush with the main brush lever.

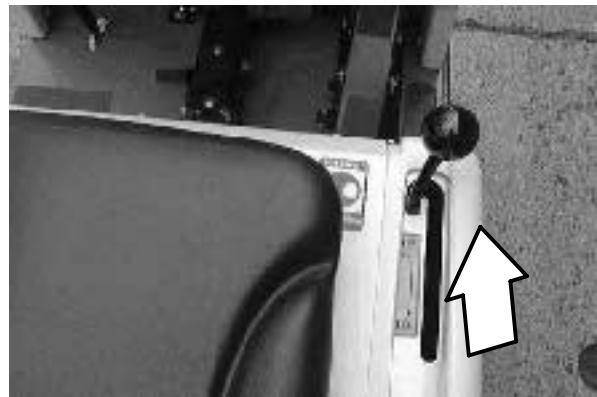

3. Press the main brush, vacuum fan and filter shaker switch to the middle off position.



4. Activate the filter shaker by **pressing down and holding** the bottom of the main brush, vacuum fan and filter shaker switch for eight to ten seconds.



OPERATION

STOPPING THE MACHINE

1. Stop sweeping. See the STOP SWEEPING section of the manual.
2. Take your foot off the directional pedal. Step on the brake pedal.

NOTE: The machine may coast for a short distance when your foot is removed from the directional pedal. Use the brake pedal to stop the machine.

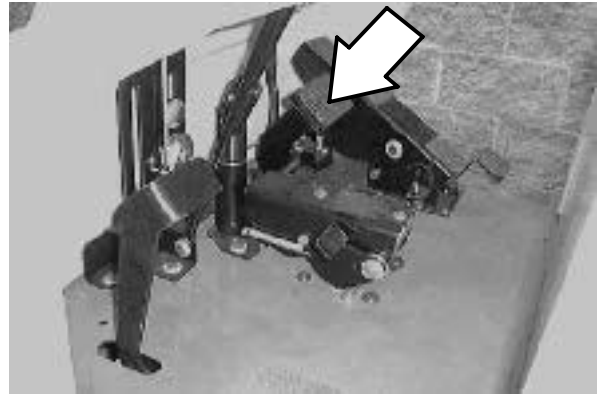

3. Set the machine parking brake.



4. Turn the machine power off. Remove the switch key.

FOR SAFETY: Before leaving or servicing machine, stop on level surface, set parking brake, turn off machine, and remove key.



EMPTYING THE HOPPER

1. Stop sweeping. See the STOP SWEEPING section of the manual.

⚠ WARNING: Brush throws debris. Stop motor before lifting hopper.

2. Drive the machine to the debris site or debris container.
3. Stop the machine. See the STOP THE MACHINE section of the manual.

FOR SAFETY: Before leaving or servicing machine, stop on level surface, set parking brake, turn off machine, and remove key.

4. Turn the hopper retaining clip up into the open position.
5. Firmly lift the hopper handle.



6. Pull back on the hopper handle. Roll the hopper out of machine.



7. Roll the hopper to debris container. Empty the hopper.

FOR SAFETY: Use care when emptying hopper. Hopper can hold up to 200lbs. Lifting heavy material improperly can result in back strain or other personal injury.



POST-OPERATION CHECKLIST

Check this list of items after you have finished sweeping:

- Check the hydraulic fluid level. (if applicable)
- Check the battery fluid and charge level.
- Check the skirts and seals for damage and wear.
- Check the condition of the sweeping brushes. Remove any string, banding, plastic wrap, or other debris wrapped around them.
- Check the sweeping brush patterns for adjustment.
- Check the condition of the hopper dust filter and seals. Clean as required.
- Check the brakes and steering for proper operation.
- Empty the debris hopper.
- Check the service records to determine maintenance requirements.

OPTIONS

VACUUM WAND

The vacuum wand uses a separate vacuum system to pick-up any debris that is out of reach of the machine.



1. Turn machine on.

NOTE: The main brush, vacuum fan and filter shaker switch does not have to be turned on for the vacuum wand system to operate.



2. Turn the cam knob counterclockwise to release the vacuum wand rod handle.

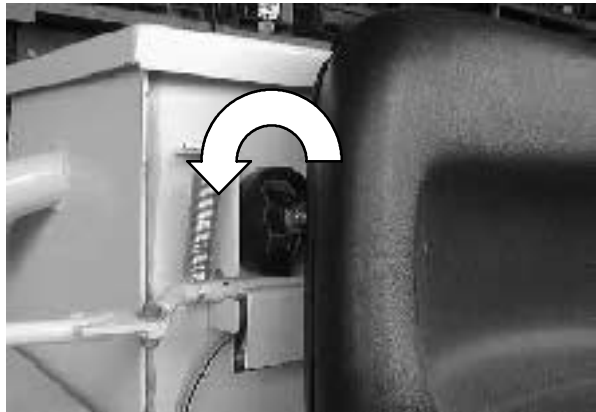

OPERATION

3. Wand On: Raise the vacuum wand from the storage position. The vacuum will turn on automatically.
4. Wand Off: Return the vacuum wand back to storage position and the vacuum will turn off.

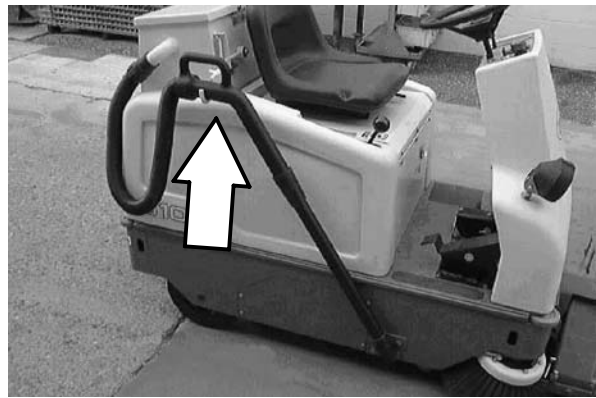

5. Turn the cam knob clockwise to secure vacuum wand rod handle.

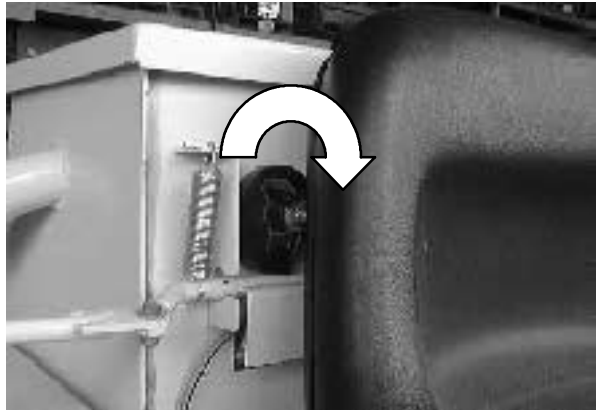

6. Replace full vacuum bags whenever wand begins to lose power or when bags are full.



QUICK MOP

The *QuickMop* is a front end sweeping attachment that widens the machine's sweeping path.

1. Drive the machine close to QuickMop attachment.
2. Set the machine parking brake and turn the machine power off.

FOR SAFETY: Before leaving or servicing machine, stop on level surface, set parking brake, turn off machine, and remove key.



3. Connect the QuickMop attachment to the mounting bracket on the front of the machine.

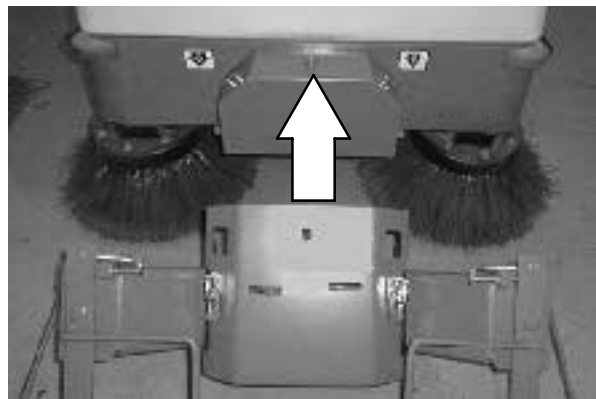

4. On older machines, hand tighten the threaded connector knob on the front of the mounting bracket. Release the parking brake and drive to the designated area to be swept.

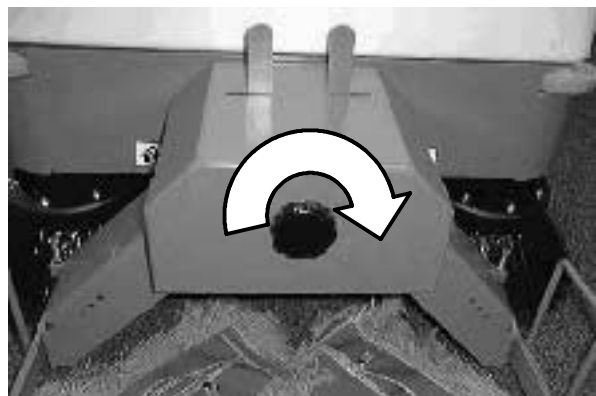

OPERATION

5. On newer machines, fasten the latches on the front of the mounting bracket. Release the parking brake and drive to the designated area to be swept.



6. Pull the release lever to raise or lower each side of the QuickMop.



7. Turn the vacuum and brushes on, lower brushes and begin sweeping.



8. Remove and refasten the QuickMop head covers with the easy to remove snaps. Remove the head covers to rotate, shake and clean at regular intervals.

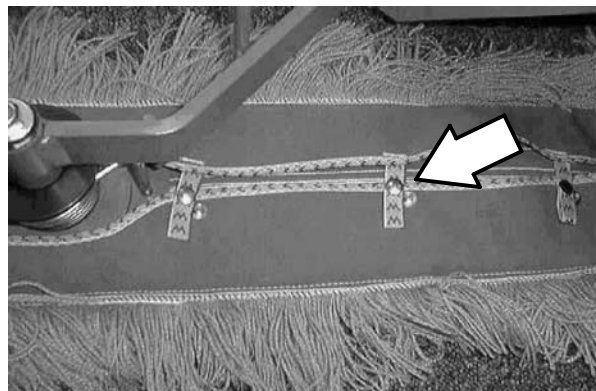

ROLLOUT BATTERY

The rollout battery allows the operator a quick and easy way to remove and replace the batteries from the machine.

1. Drive the machine to a flat, dry surface.
2. Turn the machine off and set the parking brake.

FOR SAFETY: Before leaving or servicing machine, stop on level surface, set parking brake, turn off machine, and remove key.

3. Lift the operator seat to access the batteries. The support arm automatically engages when the seat is lifted all the way up.
4. Unplug the machine connector from the batteries.

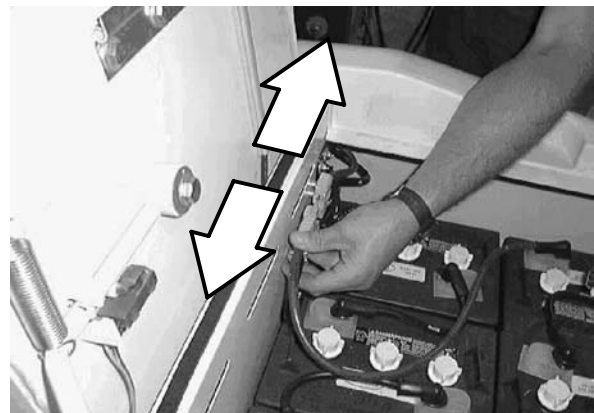

5. Remove the left side panel and push the battery cart to the left side of the machine. Line up the battery cart locks and the slots on the machine. Push the battery cart forward.

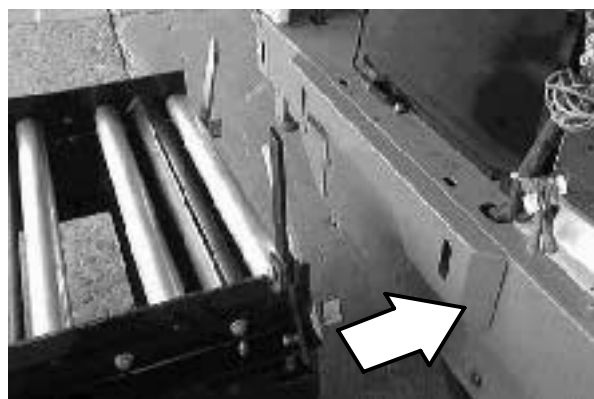

OPERATION

6. Lock the battery cart to the machine by pulling the battery cart locks towards the outside of the battery cart.



7. Set the battery cart floor lock by stepping down on the left side of the floor lock.



8. Adjust the battery cart rollers before rolling out the batteries. The battery cart rollers must be the same height as the machine battery rollers.

Raise the battery cart rollers: With a wrench, loosen the jam nut and turn the bolt clockwise. Tighten the jam nuts.

Lower the battery cart rollers: With a wrench, loosen the jam nut and turn the bolt counter-clockwise. Tighten the jam nuts.

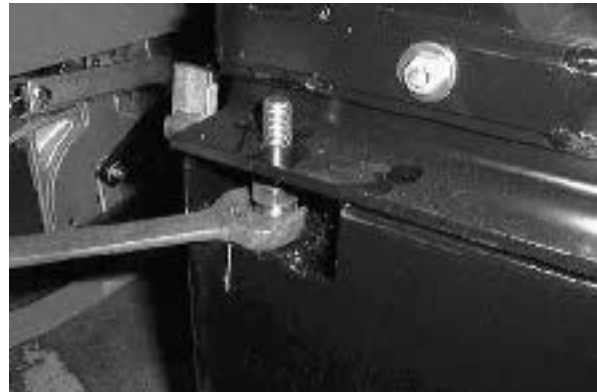

9. Turn the knob on the machine's battery stop arm counter-clockwise until it stops turning.



10. Raise the machine's battery stop arm all the way to the horizontal position.

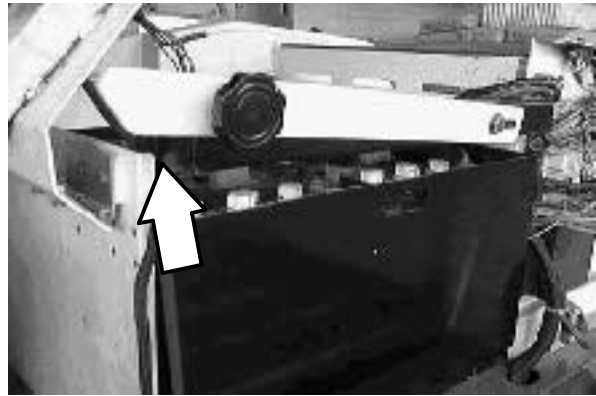

11. Raise the cart's battery stop bar by pushing down on the handle.



12. Grab the battery case slot and pull the battery case onto the battery cart.



13. Lower the cart's battery stop bar by pulling up on the handle. This will keep the batteries from rolling off the cart when moving.

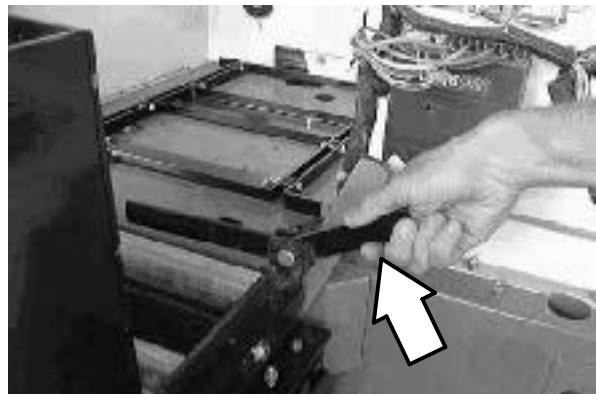

OPERATION

14. Release the battery cart from the machine by pushing the battery cart locks towards the inside of the battery cart.

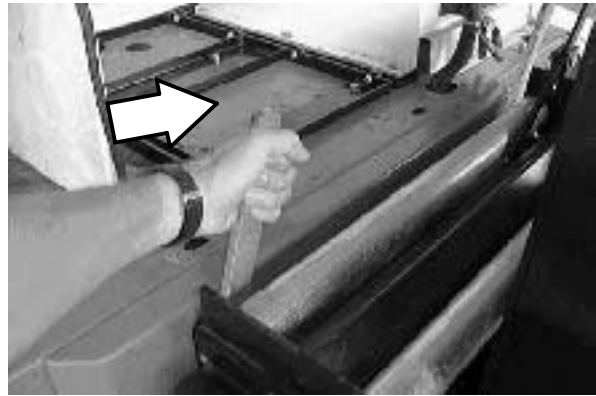

15. Release the battery cart floor lock. To release the floor lock, step down on the right side of the floor lock.

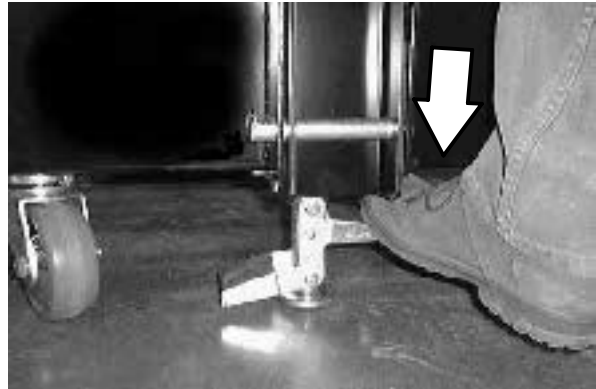

16. Pull the battery cart away from the machine.

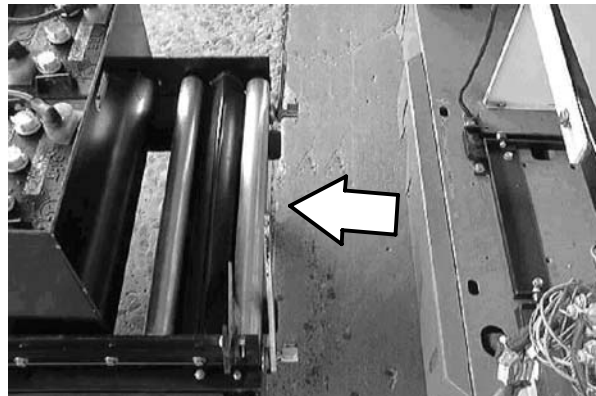

17. Reverse the previous steps to re-install the batteries in the machine.

MACHINE TROUBLESHOOTING

Problem	Cause	Remedy
Excessive dusting	Vacuum fan off	Press the main brush, vacuum and filter shaker switch to the on position
	Brush skirts and dust seals worn, damaged, out of adjustment	Replace or adjust brush skirts or dust seals
	Hopper dust filter clogged	Shake and/or clean or replace dust filter
	Vacuum hose damaged	Replace vacuum hose
	Vacuum fan failure	Contact Tennant service personnel
Poor sweeping performance	Brush bristles worn	Replace brushes
	Main and side brushes not adjusted properly	Adjust main and side brushes
	Debris caught in main brush drive mechanism	Remove debris from drive mechanism
	Main brush drive failure	Contact Tennant service personnel
	Side brush drive failure	Contact Tennant service personnel
	Hopper full	Empty hopper
	Hopper lip skirts worn or damaged	Replace lip skirts
	Wrong sweeping brush	Contact Tennant representative for recommendations
	Large debris trap damaged	Repair or replace large debris trap
No machine power	Power kill switch on	Turn kill switch clockwise until it pops up. Turn machine off and on.
	Low battery power	Check and charge batteries
	Hopper dust filter clogged	Shake and/or clean or replace dust filter
Low machine power	Low battery power	Check and charge batteries.
Machine does not propel	Power kill switch on	Turn kill switch clockwise until it pops up. Turn machine off and on.
	Low or dead batteries	Check and charge batteries
	Operator not in seat	Sit in operator seat
Vacuum Wand does not come on	Auto switch not adjusted	Adjust switch
	Low battery power	Check and charge batteries
	Wand holding bracket bent	Straighten bracket

MAINTENANCE

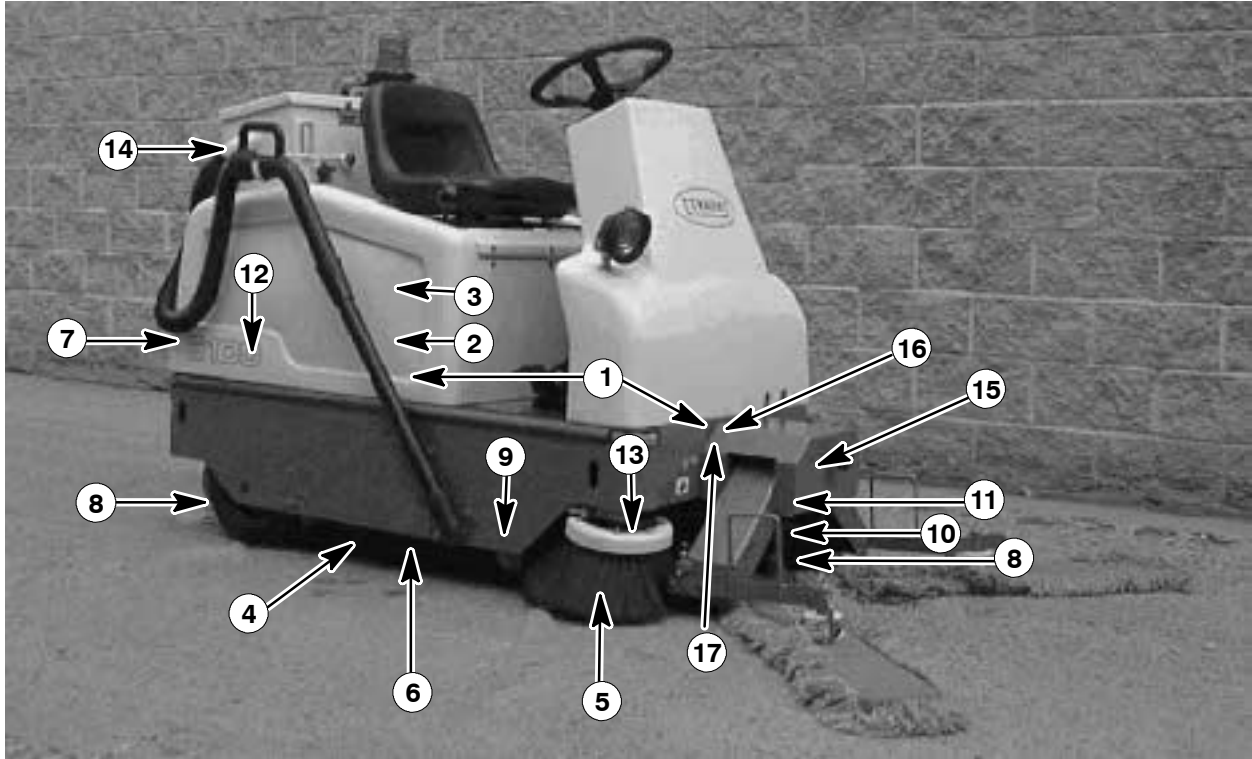

MAINTENANCE CHART

Interval	Key	Description	Procedure	Lubricant/ Fluid	No. of Service Points
Daily	6	Brush compartment skirts	Check for damage, wear, and adjustment	-	6
	4	Main brush	Check for damage or wear	-	1
	5	Side brush(es)	Check for damage or wear	-	1 (2)
			Check brush pattern	-	1 (2)
	7	Hopper dust filter	Shake	-	1
3	Batteries	Check and charge batteries	-	6 (3)	
50 Hours	4	Main brush	Rotate end-for-end	-	1
			Check brush pattern	-	1
	3	Batteries	Check electrolyte level	DW	6 (3)
	14	Vacuum wand bag (Option)	Check or change vacuum bag	-	-
		Vacuum wand fan(s) (Option)	Check for damage or wear	-	2
15	QuickMop broom (Option)	Rotate or wash sweep heads	-	2	

Interval	Key	Description	Procedure	Lubricant/ Fluid	No. of Service Points
100 Hours	7	Hopper dust filter	Check for damage, clean or replace	-	1
	8	Tires	Check for damage or wear	-	3
	9	Large Debris Trap Flap	Check for damage or wear	-	1
	10	Propelling chain (S/N 000000-002362)	Lubricate and check tension	EO	1
	12	Hopper seals	Check for damage or wear	-	4
	17	Steering castor pivot bearing	Lubricate and check for wear	SPL	1
200 Hours	11	Brake	Check adjustment	-	1
	13	Side brush(es) guard	Check for damage or wear	-	1 (2)
	2	Vacuum fan belt	Check tension and wear	-	1
	3	Main brush belt	Check for wear	-	1
	16	Steering gear chain	Lubricate	EO	1
800 Hours	1	Electric motors	Check carbon brushes	-	3

LUBRICANT/FLUID

DW Distilled water

EO SAE 30 Engine oil

SPL . . . Special lubricant, Lubriplate EMB grease (TENNANT part no. 01433-1)

NOTE: More frequent intervals may be required in extremely dusty conditions.

LUBRICATION

PROPELLING SYSTEM (For machines below serial number 002363)

The front wheel chain drive/support propels the front wheel to drive the machine. Check the propelling system and chain tension every 100 hours. Proper chain tension is 3 mm (.125 in) from slight tension applied at the midpoint of the longest span. Lubricate the propelling chain with SAE 30-weight engine oil after every 100 hours of operation.

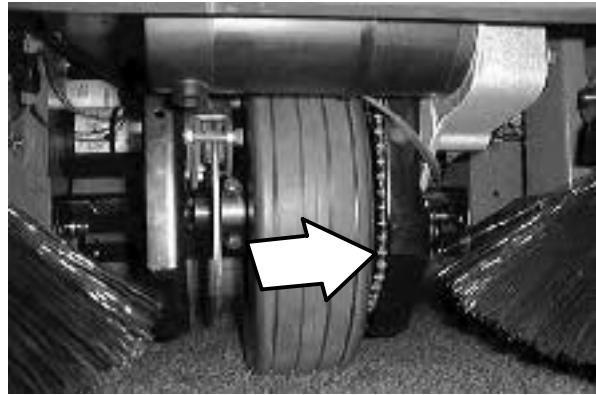

STEERING GEAR CHAIN (For machines below serial number 002363)

The steering chain turns the front wheel as the steering wheel is turned. Lubricate the steering chain with SAE 30-weight engine oil every 200 hours of operation.

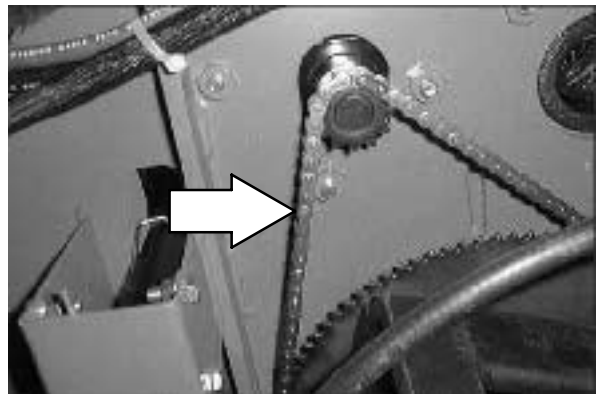

STEERING GEAR CHAIN (For machines serial number 002363 and above)

The steering gear chain is located directly above the front tire.

Lubricate with SAE 90 weight gear lubricant every 200 hours of use.

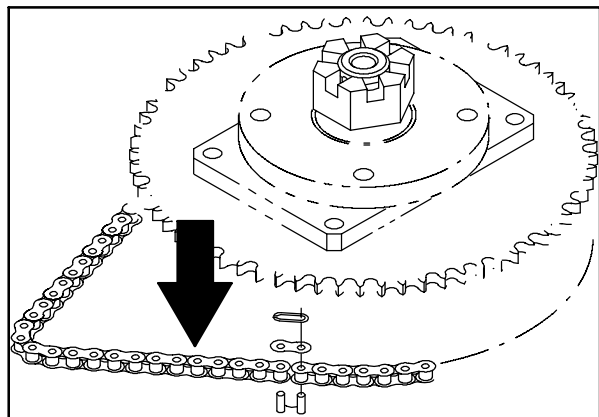

STEERING CASTOR PIVOT BEARING (For machines below serial number 002363)

The steering castor bearing is located under the front wheel housing. Lubricate the bearing with Lubriplate EMB grease (TENNANT part no. 01433-1) every 100 hours.



STEERING CASTER PIVOT BEARING (For machines serial number 002363 and above)

The steering caster bearing is located on the floorplate. Lubricate with Lubriplate EMB grease (TENNANT part no. 01433-1) every 100 hours.

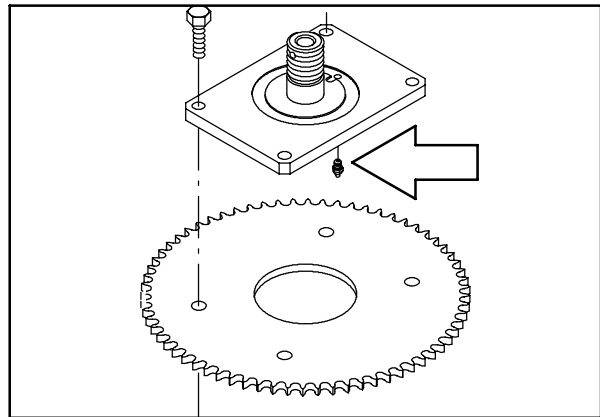

BATTERIES

The batteries are unique in that they hold their power for long periods of time. The lifetime of the batteries is limited by the number of charges the batteries receive. To get the most life from the batteries, charge them when the last battery discharge indicator segment flashes (20% charge left). Use an automatic charger with the proper rating for the batteries.

Periodically clean the top surface of the batteries and the terminals, and check for loose connections. Use a strong solution of baking soda and water. Brush the solution sparingly over the battery tops, terminals, and cable clamps. Do not allow any baking soda solution to enter the batteries. Use a wire brush to clean the terminal posts and the cable connectors. After cleaning, apply a coating of clear battery post protectant to the terminals and the cable connectors. Keep the tops of the batteries clean and dry.

Keep all metallic objects off the top of the batteries, which may cause a short circuit. Replace any worn or damaged wires.

Check the electrolyte level in each battery cell before and after charging, and after every 50 hours of operation. Do not charge the batteries unless the fluid is slightly above the battery plates. If needed, add just enough distilled water to cover the plates. Never add acid to the batteries. Do not overfill. Always keep the battery caps on, except when adding water or taking hydrometer readings.

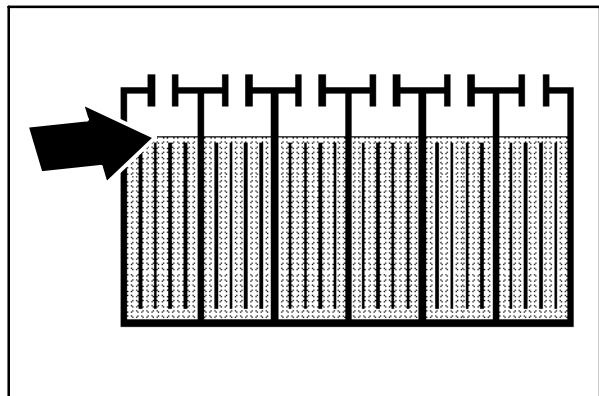

Measuring the specific gravity, using a hydrometer, is a way to determine the charge level and condition of the batteries. If one or more of the battery cells test lower than the other battery cells (0.050 or more), the cell is damaged, shorted, or is about to fail.

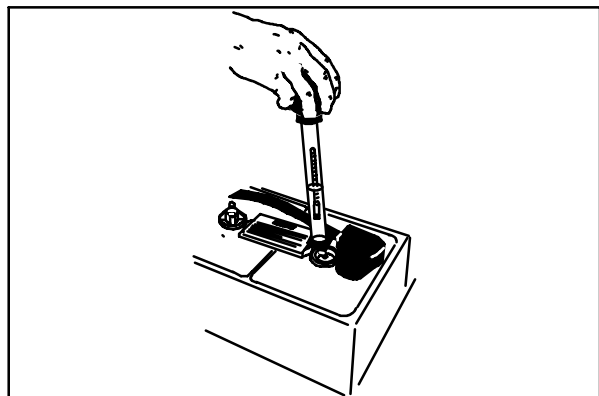

04380

NOTE: Do not take readings immediately after adding distilled water. If the water and acid are not thoroughly mixed, the readings may not be accurate. Check the hydrometer readings against the following chart to determine the remaining battery charge level:

Spec. Gravity at 27° C (80° F)	
Charge Level	220 AH Battery
100 %	1.265
75 %	1.223
50 %	1.185
25 %	1.148
Discharged	1.110

NOTE: If the readings are taken when the battery electrolyte is any temperature other than shown, the reading must be temperature corrected. Add or subtract to the specific gravity reading 0.004, 4 points, for each 6° C (10° F) above or below 27° C (77° F).

CHARGING THE BATTERIES

1. Drive the machine to a flat, dry surface in a well-ventilated area.
2. Stop the machine, set the parking brake and turn the machine power off.

FOR SAFETY: Before leaving or servicing machine, stop on level surface, set parking brake, turn off machine, and remove key.

3. Open the seat support.
4. Check the water level in all the battery cells.

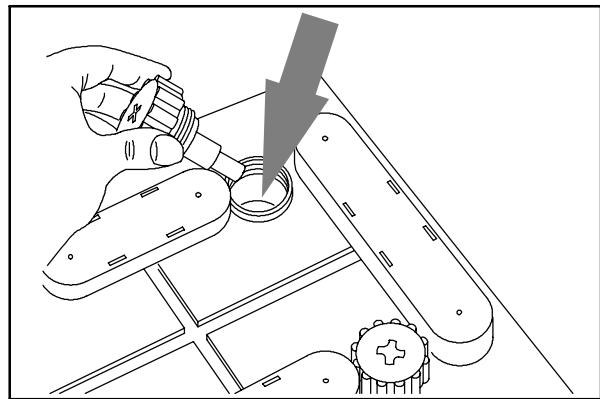

08247

MAINTENANCE

5. If the level is low, add just enough distilled water to cover the battery plates. DO NOT OVERFILL. The batteries can overflow during charging due to expansion.

NOTE: Make sure the battery caps are in place while charging.

FOR SAFETY: When maintaining or servicing machine, avoid contact with battery acid.

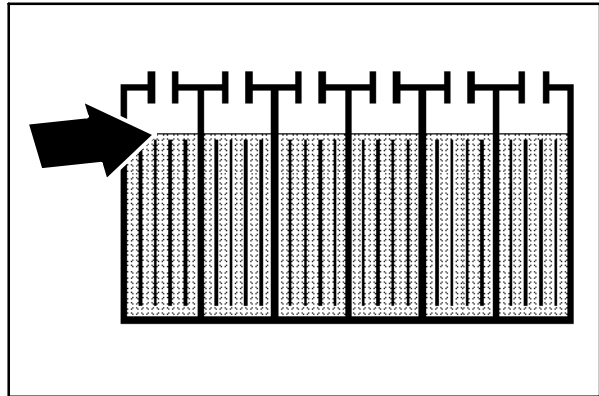

6. Unplug the battery connector from the machine connector.



7. Plug the connector from the batteries into the battery charger connector.

⚠ WARNING: Batteries emit hydrogen gas. Explosion or fire can result. Keep sparks and open flame away. Keep covers open when charging.

NOTE: Plug the charger connector into connector that runs to the batteries. Do not plug charger into mounted connector. Damage may occur to the machine.

NOTE: If the red "ABNORMAL CYCLE" lamp lights when the batteries are plugged into the TENNANT charger, this indicates that something is wrong with the battery. The charger can not charge the battery when this happens.

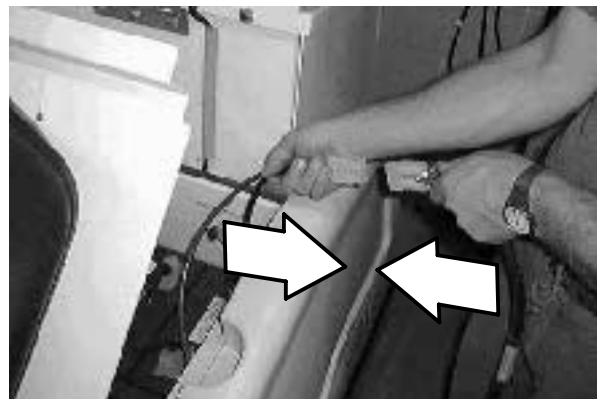

8. The Tennant charger will start automatically. When the batteries are fully charged, the Tennant charger will automatically turn off.

NOTE: Use a charger with the proper rating for the batteries to prevent damage to the batteries or reduce the battery life.

NOTE: If the charger needs to be disconnected from the machine before the batteries are fully charged and the charger has not automatically shut off, turn off the charger before disconnecting it.

9. After the charger has turned off, unplug the charger connector from the battery connector on the machine.

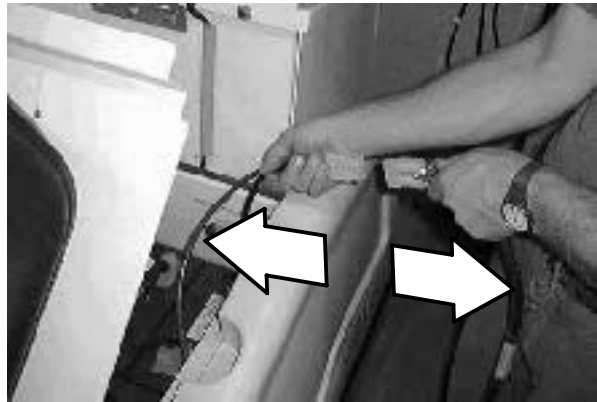

10. Reconnect the battery connector to the machine connector.
11. Check the electrolyte level in each battery cell after charging. If needed, add distilled water to raise the electrolyte level to about 12 mm (0.40 in) below the bottom of the sight tubes.

FOR SAFETY: When maintaining or servicing machine, avoid contact with battery acid.

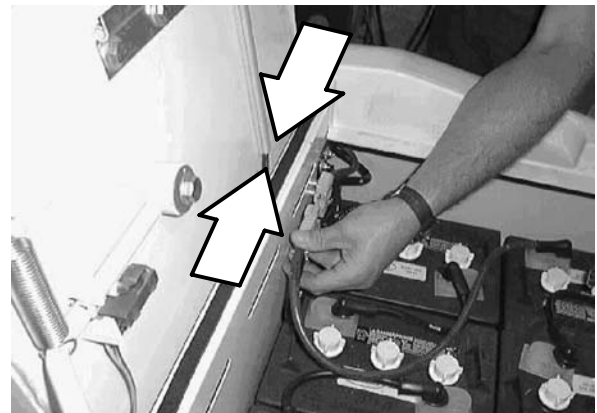

12. Close the seat support.

MAINTENANCE

ELECTRIC MOTORS

The carbon brushes on the propelling and accessories motors should be inspected after every 800 hours of machine operation.

BELTS AND CHAINS

VACUUM FAN BELT

Check the vacuum fan belt tension and wear after every 200 hours of operation. The correct tension is when the belt deflects 12.7 mm (0.50 in) from a force of 15 kg (30 to 40 lb) at belt midpoint.

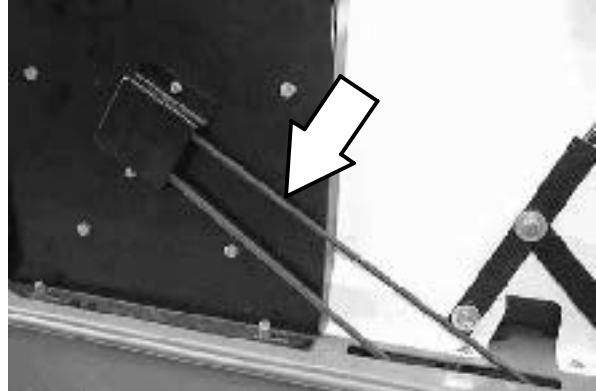

MAIN BRUSH BELT

Check the main brush belt for wear after every 200 hours of operation. The idler keeps tension on the belt. The tension is set manually.

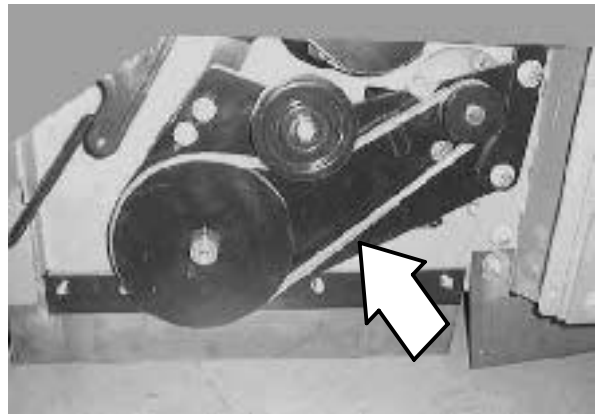

PROPELLING CHAIN (For machines below serial number 002363)

The front wheel chain drive/support propels the front wheel to drive the machine. Check the propelling system and chain tension every 100 hours. Proper chain tension is 3 mm (.125 in) from slight tension applied at the midpoint of the longest span. Lubricate the propelling chain with SAE 30-weight engine oil after every 100 hours of operation.

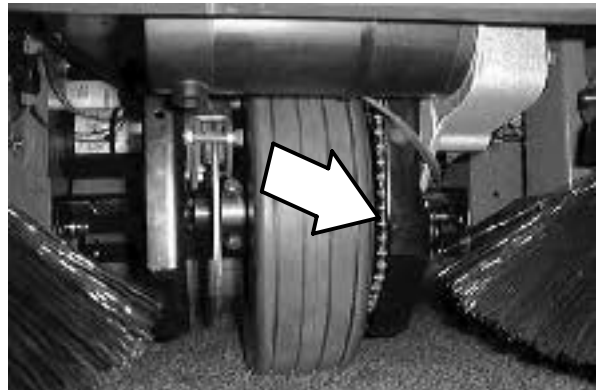

STEERING GEAR CHAIN (For machines below serial number 002363)

The steering chain turns the front wheel as the steering wheel is turned. Lubricate the steering chain with SAE 30-weight engine oil every 200 hours of operation.

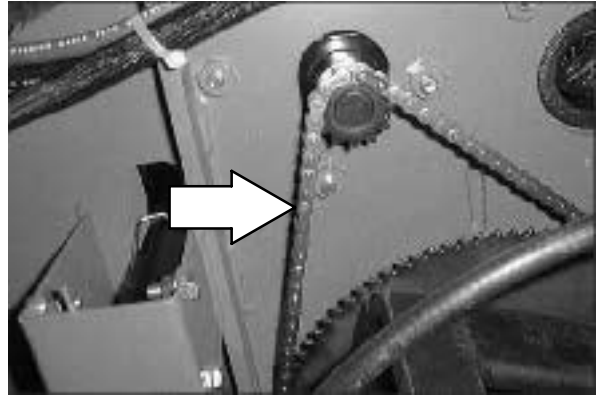
**STEERING GEAR CHAIN (For machines serial number 002363 and above)**

The steering gear chain is located directly above the front tire.

Lubricate with SAE 90 weight gear lubricant every 200 hours of use.

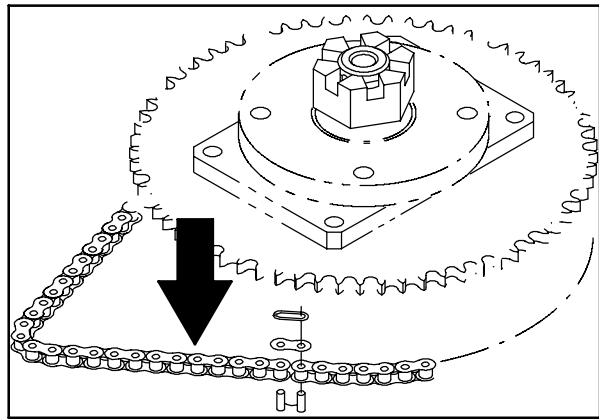
**STATIC DRAG CHAIN**

A static drag chain prevents the buildup of static electricity in the machine. The chain is attached to the machine by a rear main brush skirt retaining bolt.

Make sure the chain is touching the floor at all times.

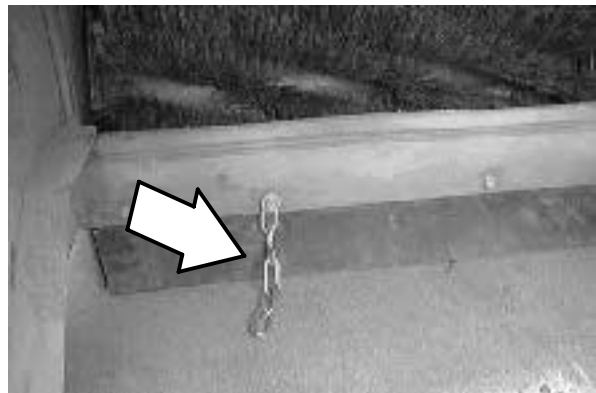

DEBRIS HOPPER

INSTANT ACCESS HOPPER FILTER

The Instant Access hopper filter filters the air pulled up from the hopper. The dust filter is equipped with a shaker to remove the accumulated dust particles. The dust filter shaker is operated by the main brush, vacuum and filter shaker switch.

Shake the dust filter before emptying the hopper and at the end of every work shift. Check and clean or replace the dust filter after every 100 hours of operation.

To clean the Instant Access filter, use one of the following methods:

- **SHAKING** - Press and hold the main brush, vacuum and filter shaker switch to the **Filter shaker** position.
- **TAPPING** - Remove the filter and tap the filter gently on a flat surface with the dirty side down. Do not damage the edges of the filter element and seals, or the filter will not seat properly in the filter frame.
- **AIR** - Always wear eye protection when using compressed air. Blow air through the dust filter opposite the direction of the arrows. Never use more than 690 kPa (100 psi) of air pressure and never closer than 50 mm (2 in) away from the filter.

FOR SAFETY: When servicing machine, wear eye and ear protection if using pressurized air or water.



REMOVING INSTANT ACCESS FILTER

1. Stop the machine, set the parking brake and turn the machine power off.

FOR SAFETY: Before leaving or servicing machine, stop on level surface, set parking brake, turn off machine, and remove key.

2. Turn the hopper retaining clip and remove hopper.



3. Unlatch the two dust filter securing latches above the hopper storage area.

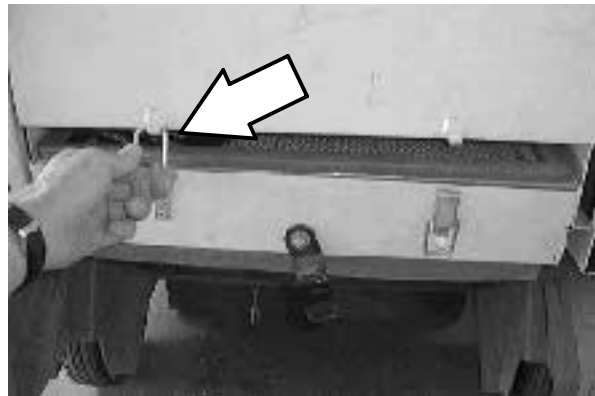

4. Lower the hopper filter down to access the VCS filter shaker.

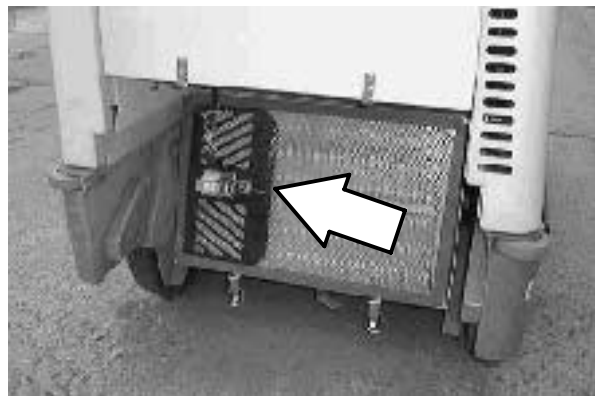

MAINTENANCE

5. Unplug the electrical harness connection from the VCS system filter shaker.

NOTE: Carefully pull the wires apart from the bodies of the plugs. Do not unplug the connections from the shaking mechanism. Do not pull on the wires. Damage could occur to the wires or the shaking mechanism.

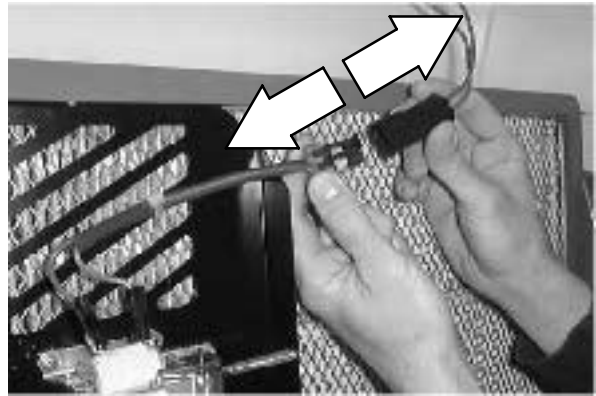

6. Lift the Instant Access filter from filter tray.



7. Lift the VCS system filter shaker off of the filter.

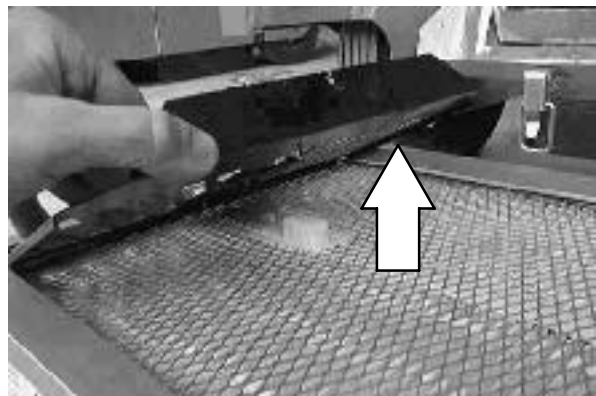

8. Clean or discard the Instant Access filter as required.

9. Replace the VCS system filter shaker. Use care to insert the shaking pin into the filter comb correctly.

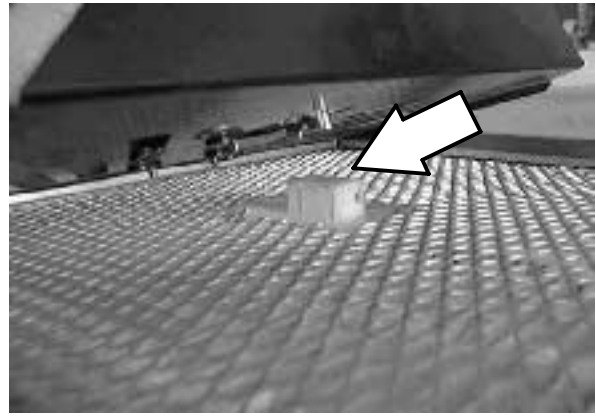

10. Place the edges of the shaker firmly between the filter and the filter seal.

NOTE: When installed properly, the shaker plate cannot move in either front-to-back or side-to-side directions. If the shaker is loose, it will not function properly.



11. The filter shaker should lay flat against the filter. Check to make sure the comb tab is not caught below the filter shaker plate.

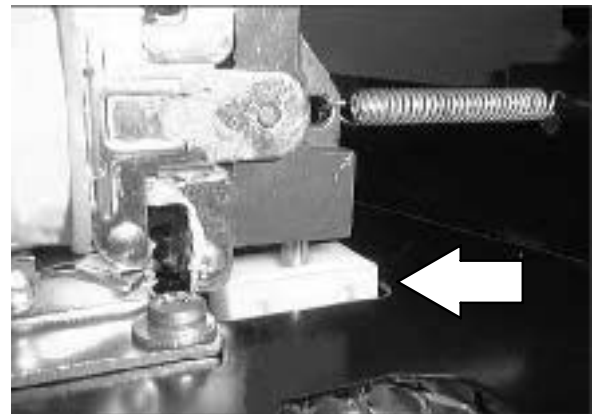

MAINTENANCE

12. Check the shaker solenoid gap with the end of the shipping tab. The gap should be the same width as the tab. If it is not, loosen the mounting screws, adjust the gap by repositioning the shaker solenoid, then retighten the screws.

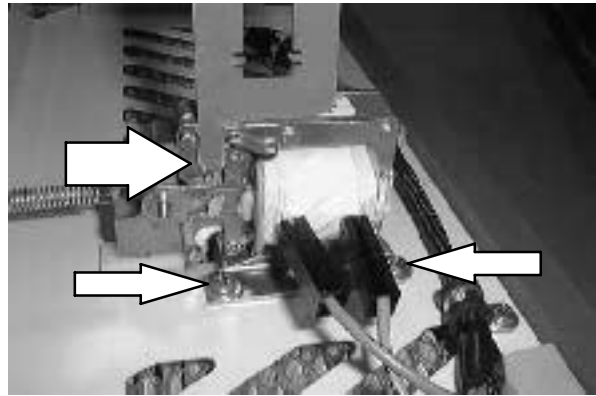

13. Return the filter back to the machine.

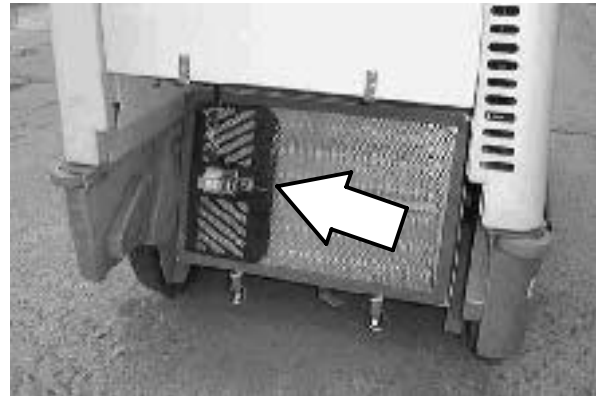

14. Reconnect the electrical harness to the shaker mechanism harness.

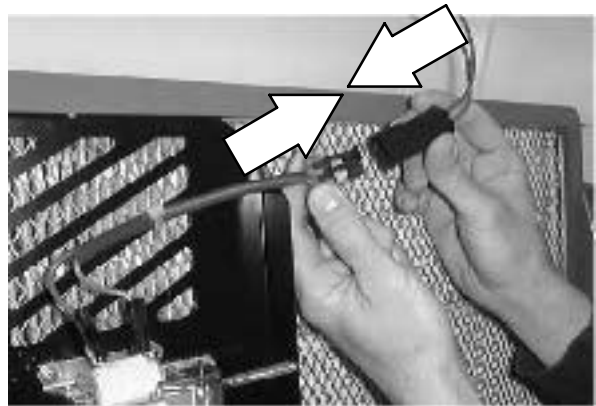

- 15. Latch the two dust filter securing latches above the hopper storage area.

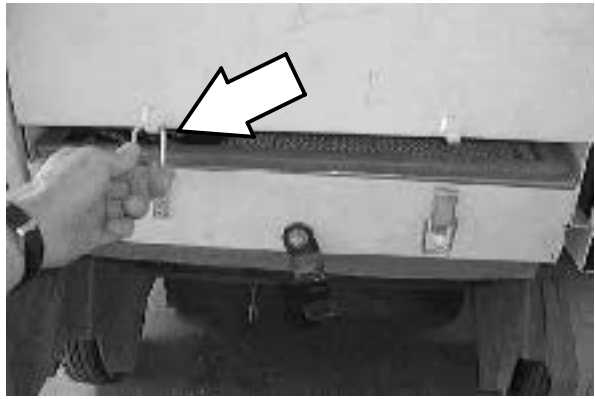

- 16. Check all of the hopper seals for wear.



- 17. Replace the hopper.



BRUSHES

MAIN BRUSH

The main brush is cylindrical and spans the width of the machine, sweeping debris into the hopper.

Check the brush daily for wear or damage. Remove any string or wire tangled on the main brush, main brush drive hub, or main brush idler hub.

Check the main brush pattern weekly. The pattern should be 50 to 75 mm (2 to 3 in) wide with the main brush in the lowered position.

Rotate the main brush end-for-end after every 50 hours of operation for maximum brush life and best sweeping performance.

Sweeping performance often becomes less effective as the bristle length is worn. Replace the main brush when the remaining bristles measure between 40 mm (1-1/2 in) and 50 mm (2 in) in length.

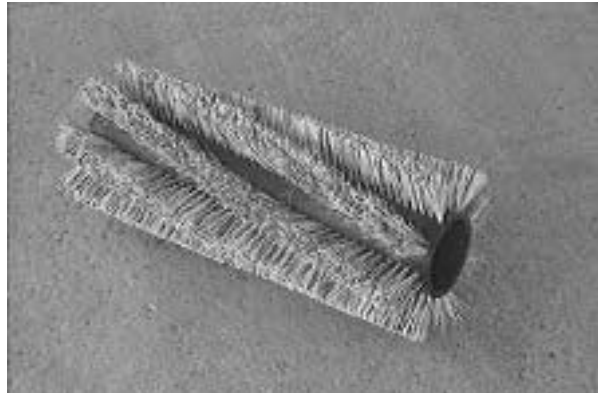

REPLACING MAIN BRUSH

1. Stop the machine, set the parking brake and turn the machine power off.

FOR SAFETY: Before leaving or servicing machine, stop on level surface, set parking brake, turn off machine, and remove key.

2. Open the left side main brush access door.

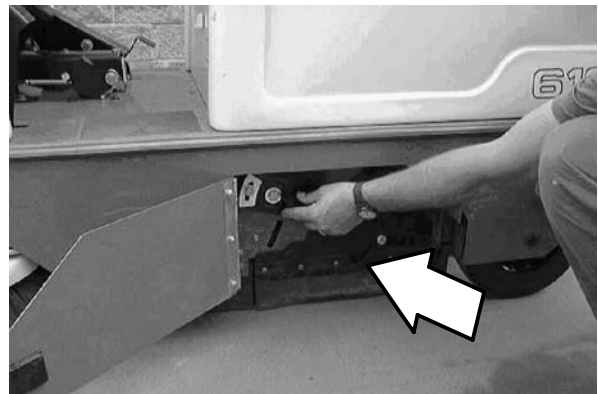

3. Loosen the idler arm mounting knob and three other side skirt mounting knobs. Remove the brush idler arm assembly.

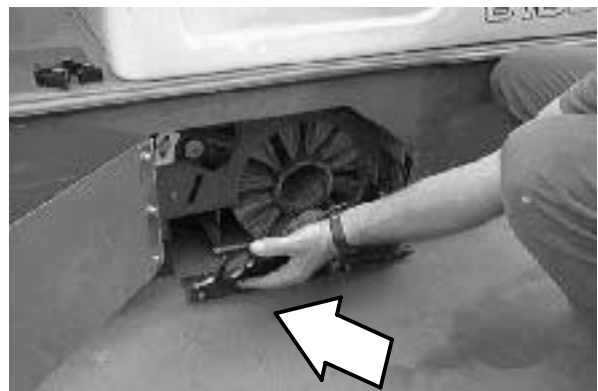

4. Grasp the main brush; pull it off the brush drive plug and out of the main brush compartment.
5. Put the new or rotated end-for-end main brush on the floor next to the access door.
6. Slide the main brush onto the drive plug. Rotate the brush until it engages the drive plug, and push it all the way onto the plug.



7. Check that the recirculation skirt is tucked in behind the frame.
8. Slide the main brush idler arm plug onto the main brush.



9. Secure the idler arm on the bolts. Hand tighten the mounting knobs.
10. Close the main brush access door.

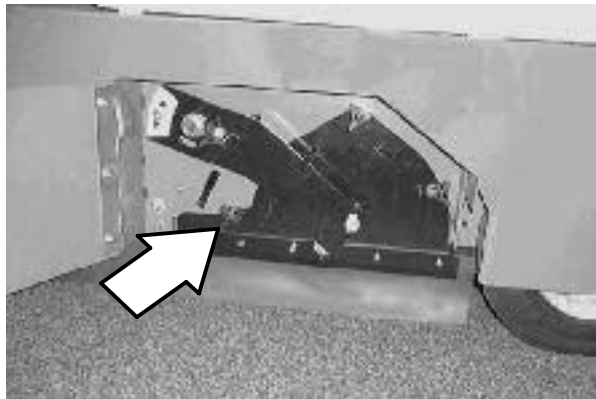

CHECKING AND ADJUSTING MAIN BRUSH PATTERN

1. Apply chalk, or some other material that will not blow away easily, to a smooth, level floor.
2. Raise the side brush and main brush and position the main brush over the chalked area.
3. Start and lower the main brush for 15 to 20 seconds while keeping a foot on the brakes to keep the machine from moving.

NOTE: If chalk or other material is not available, allow the brushes to spin on the floor for two minutes. A polish mark will remain on the floor.

4. Raise the main brush.
5. Drive the machine off the test area.

MAINTENANCE

6. Observe the width of the brush pattern. The proper brush pattern width is 50 to 75 mm (2 to 3 in).

The brush taper is factory set and should not need adjustment unless parts of the brush system have been replaced.

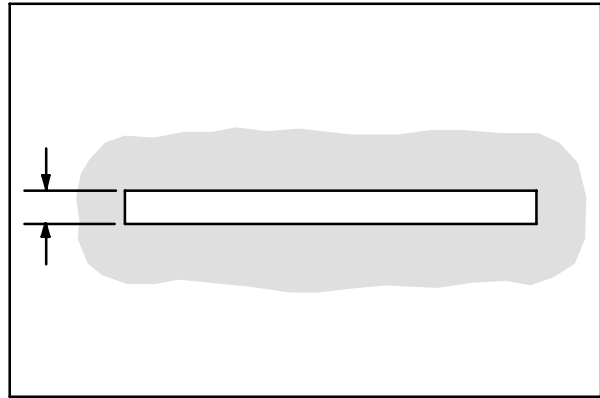

00582

If the main brush pattern is tapered, more than 15 mm (0.5 in) on one end than the other, adjust the taper as follows:

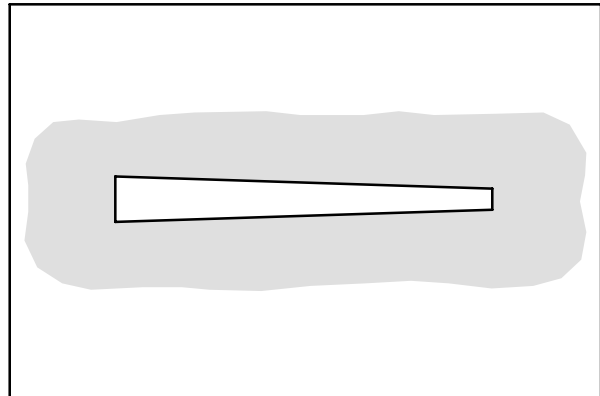

00601

- A. Loosen the brush shaft bearing bracket mounting bolt and the idler arm securing head.
- B. Allow the brush to operate and float into position for approximately 30 seconds.
- C. Tighten the adjustment bolt and idler arm securing knob.
- D. Check the main brush pattern and readjust as necessary.

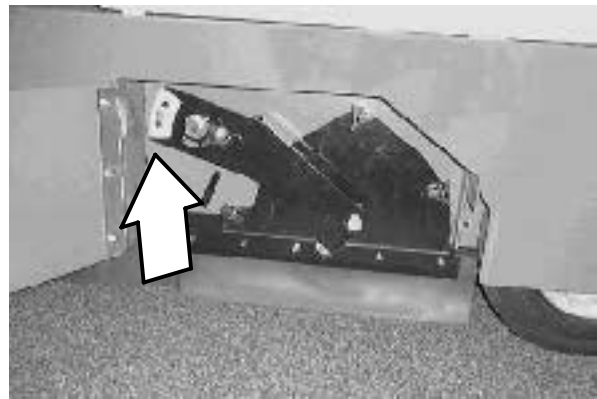

SIDE BRUSH

The side brush sweeps debris along edges into the path of the main brush.

Check the brush daily for wear or damage. Remove any string or wire found tangled on the side brush or side brush drive hub.

Check the side brush pattern daily. The side brush bristles should contact the floor in a 10 o'clock to 3 o'clock pattern when the brush is in motion.

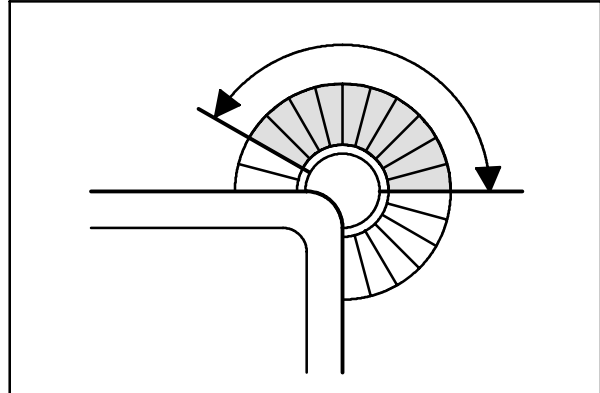

350327

Adjust the side brush pattern by loosening the hex screw located above the side brush pulley. Move the pulley mount bracket up or down to achieve the proper side brush pattern. Retighten the hex screw.



The side brush should be replaced when it no longer sweeps effectively for your application. A guideline length is when the remaining bristles measure 50 mm (2 in) in length. You may need to replace the side brush sooner if you are sweeping light litter or use a brush with shorter bristles if you are sweeping heavy debris.

MAINTENANCE

REPLACING SIDE BRUSH

1. Stop the machine, set the parking brake and turn the machine power off.

FOR SAFETY: Before leaving or servicing machine, stop on level surface, set parking brake, turn off machine, and remove key.

2. Remove the side brush retaining pin from the side brush drive shaft by pulling the pin keeper off over the end of the pin.
3. Slide the side brush off the side brush drive shaft.
4. Slide the new side brush onto the side brush drive shaft.
5. Insert the side brush retaining pin through the side brush hub and shaft.
6. Secure the pin by clipping the pin keeper over the end of the pin.
7. Adjust the side brush pattern with the side brush pulley mount bracket.



SIDE BRUSH GUARD

Check the side brush guard after every 200 hours of operation. Replace the brush guard after it begins to show serious wear.



SKIRTS AND SEALS

REAR SKIRT

The two rear skirts are located on the bottom rear of the main brush compartment. The vertical skirt should clear the floor up to 5 mm (0.25 in). The recirculation skirt requires no adjustment.

Check the skirts for wear or damage and adjustment daily.

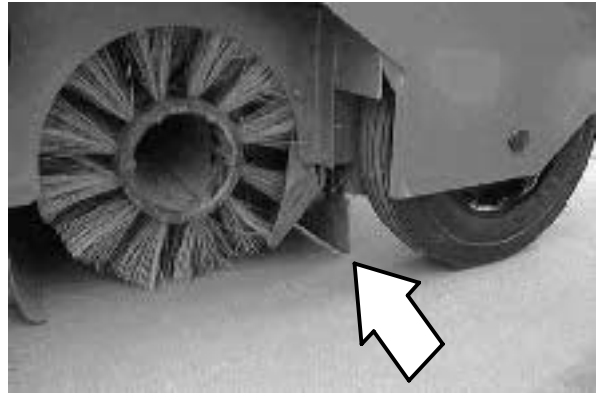

NOTE: The recirculation skirt must be folded in between the brush and the machine frame before the brush door is mounted on for the machine to work properly.

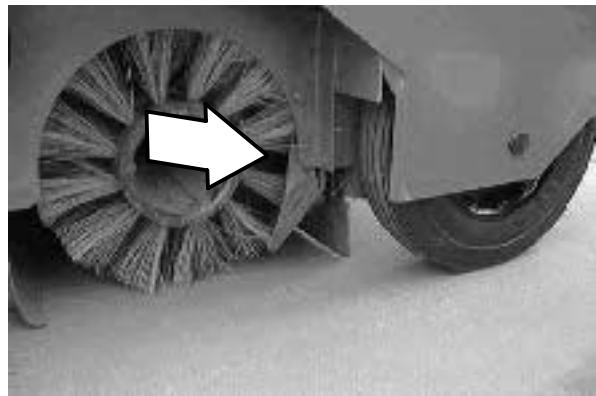
**SIDE SKIRTS**

The side skirts are located on both sides of the main brush compartment. The skirts should clear the floor up to 5 mm.

Check the skirts for wear or damage daily.



MAINTENANCE

LARGE DEBRIS TRAP SKIRT

The large debris trap skirt is located along the front of the main brush. This skirt is raised and lowered by the large debris trap pedal, allowing larger debris to be trapped and swept up into the hopper.

Check the skirt for wear or damage after every 100 hours of operation.

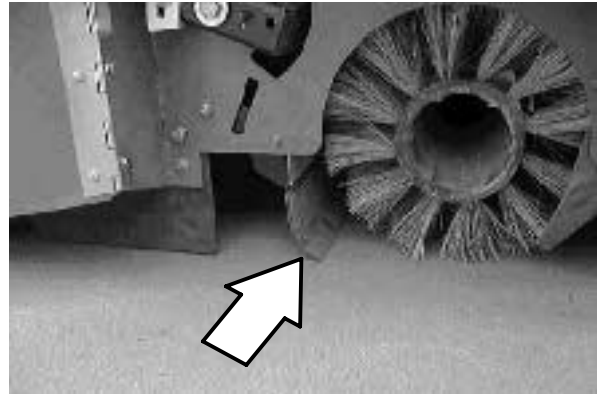

HOPPER SEALS

The hopper seals are located along the back of the main brush. The hopper rests on the seals when the hopper is setting in proper sweeping position.

Check the seals for wear or damage after every 100 hours of operation.

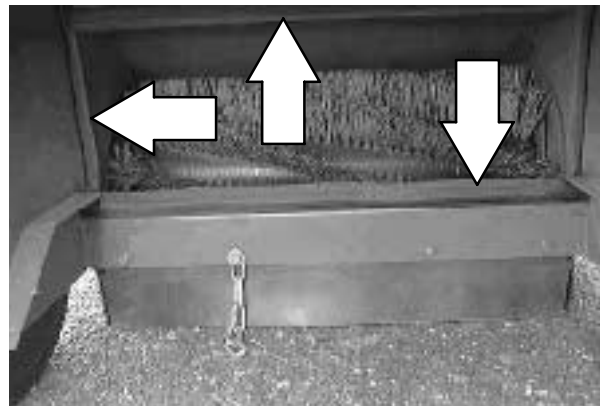

The upper hopper seal is located above the hopper on the bottom of the filter weldment. Check the seal for wear or damage after every 100 hours of operation.

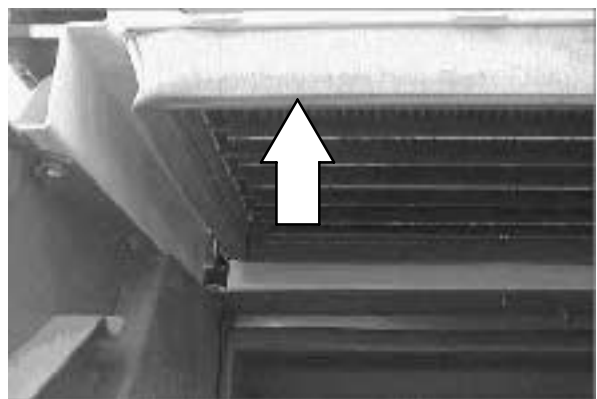

BRAKES AND TIRES

BRAKES (For machines below serial number 002363)

The mechanical brake is located on the front wheel. The brake is operated by the brake foot pedal.

Check the brake adjustment after every 200 hours of operation. If the brake does not respond well to pressure on the brake pedal, you may need to adjust the brake.

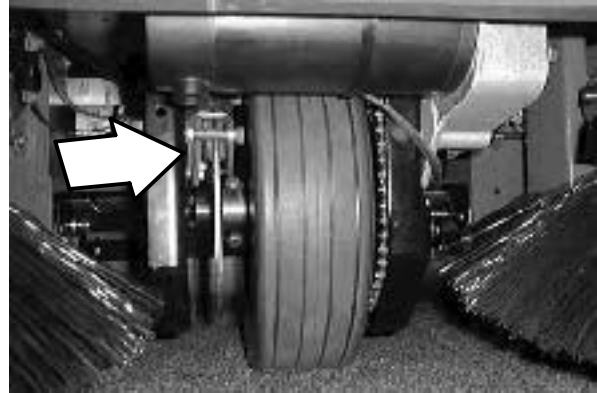

To Adjust Brakes:

Remove the cotter key from the brake extension arm, and position the extension arm in the next adjustment hole in the brake link.

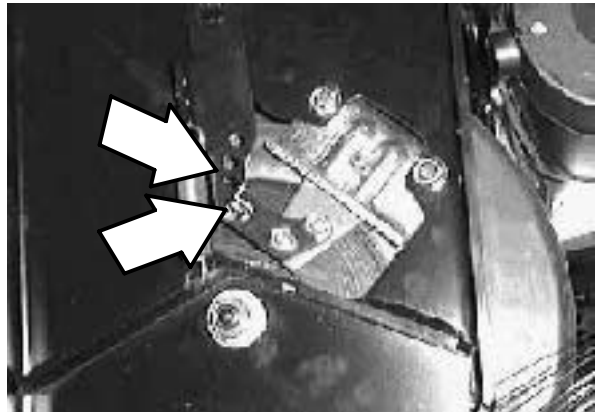

Insert the cotter key back into the brake extension arm, and check the brake for proper operation.

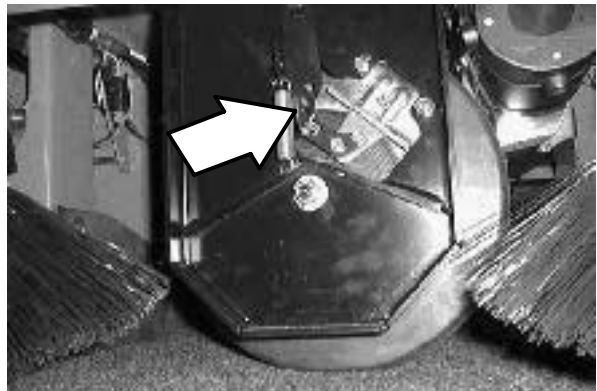

MAINTENANCE

BRAKES (For machines serial number 002363 and above)

The mechanical brake is located on the front wheel. The *brake* is operated by the *brake pedal*.

Check the brake adjustment after every 200 hours of operation. If the brake does not respond well to pressure on the brake pedal, you may need to adjust the brake.



BRAKE ADJUSTMENT:

Remove the cotter key from the brake extension arm, and position the extension arm in the next adjustment hole in the brake link.

Insert the cotter key back into the brake extension arm, and check the brake for proper operation.

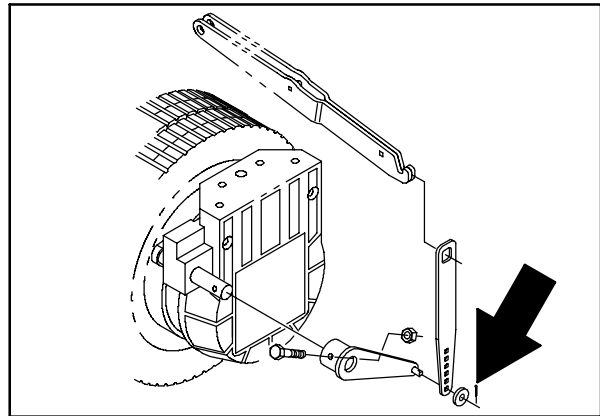

TIRES

The machine has three tires: one in front, and two in the rear of the machine. All three tires are solid rubber. Check the tires for damage and wear after every 100 hours of operation.



PUSHING, TOWING, AND TRANSPORTING THE MACHINE

PUSHING OR TOWING THE MACHINE

If the machine becomes disabled, it can be pushed or towed from the front or rear, but it is easier and more stable to tow from the front end.

(For machines below serial number 002363)
Unplug the drive motor from the electrical harness before attempting to push the machine. The machine will become easier to maneuver when it is unplugged.

ATTENTION! Do not push or tow the machine for a long distance and without unplugging the drive motor or damage may occur to the propelling system.

Only push or tow the machine for a *very short distance* and do not exceed 3.2 kp/h (2 mph). It is NOT intended to be pushed or towed for a long distance or at a high speed.

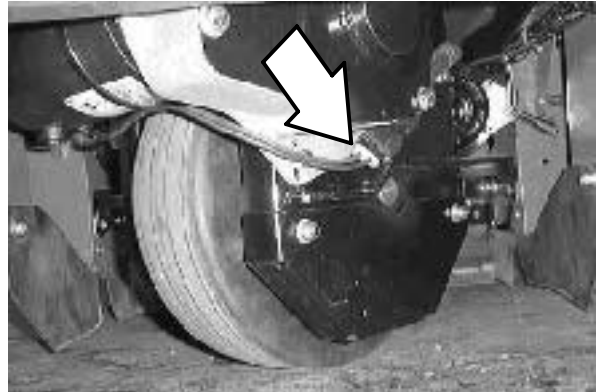

TRANSPORTING THE MACHINE

1. Position the front of the machine at the loading edge of the truck or trailer.

FOR SAFETY: Use truck or trailer that will support the weight of the machine.

NOTE: Empty the hopper before transporting the machine.

2. If the loading surface is not horizontal or is higher than 380 mm (15 in) from the ground, use a winch to load machine.

If the loading surface is horizontal AND is 380 mm (15 in) or less from the ground, the machine may be driven onto the truck or trailer.

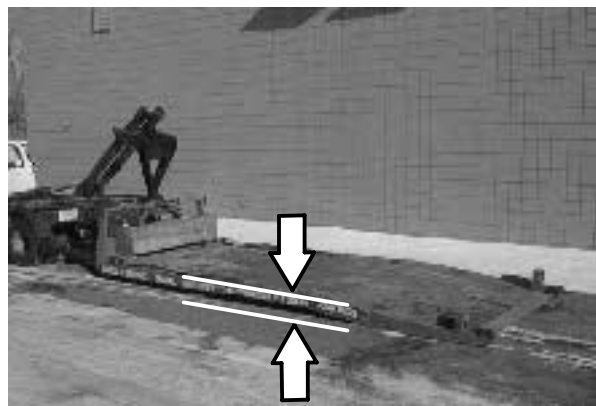

3. To winch the machine onto the truck or trailer, attach the winching chains to the front tie down located in the front of the machine frame.

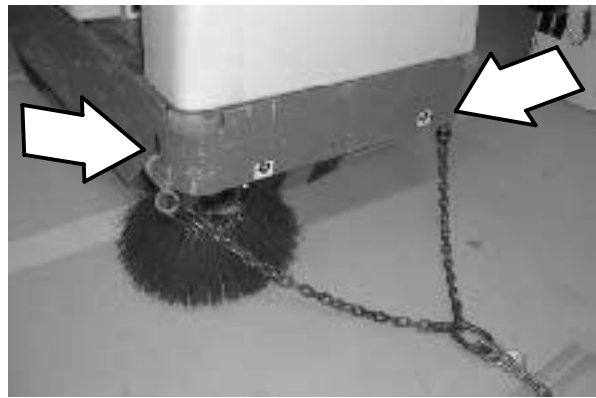

4. (For machines below serial number 002363) Unplug the drive motor from the electrical harness before winching the machine onto the truck or trailer. See *PUSHING OR TOWING THE MACHINE* section of this manual. Make sure the machine is centered.

FOR SAFETY: When loading machine onto truck or trailer, use winch. Do not drive the machine onto the truck or trailer unless the loading surface is horizontal AND is 380 mm (15 in) or less from the ground.

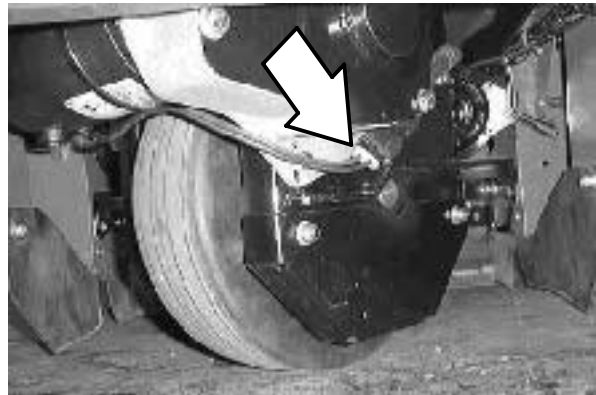

5. Position the machine onto the truck or trailer as far as possible. If the machine starts to veer off the centerline of the truck or trailer, stop and turn the steering wheel to center the machine.

MAINTENANCE

6. Set the parking brake and block the machine tires. Tie down the machine to the truck or trailer before transporting.

The front tie-down locations are the holes in the front of the machine frame.

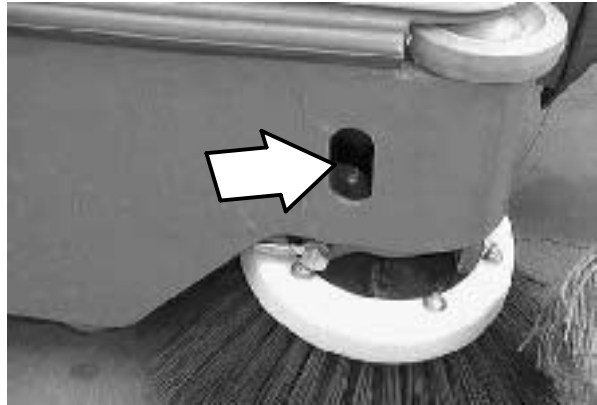

The rear tie-down locations are the holes in the sides of the machine frame near the rear bumper.



7. If the loading surface is not horizontal or is higher than 380 mm (15 in) from the ground, use a winch to unload machine.

If the loading surface is horizontal AND is 380 mm (15 in) or less from the ground, the machine may be driven off the truck or trailer.

FOR SAFETY: When unloading machine off truck or trailer, use winch. Do not drive the machine off the truck or trailer unless the loading surface is horizontal AND 380 mm (15 in) or less from the ground.

MACHINE JACKING

Empty the hopper before jacking the machine. You can jack up the machine for service at the designated locations. Use a hoist or jack that will support the weight of the machine. Always stop the machine on a flat, level surface and block the tires before jacking up the machine.

FOR SAFETY: Before leaving or servicing machine, stop on level surface, set parking brake, turn off machine, and remove key.

The front jacking locations are on the flat bottom edge of the front of the machine frame.



The rear jacking locations are on the corners of the rear frame.

FOR SAFETY: When servicing machine, block machine tires before jacking up machine.

FOR SAFETY: When servicing machine, jack up machine at designated locations only. Block machine up with jack stands.

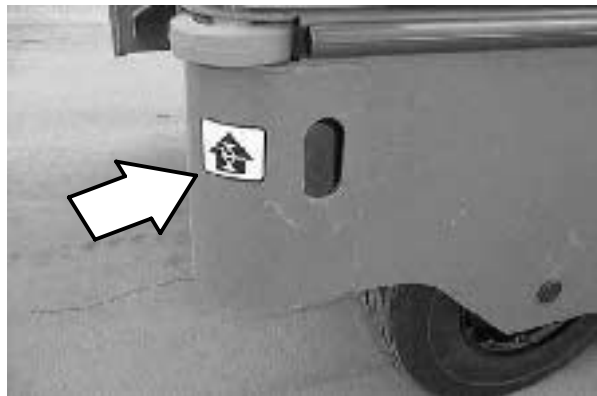

STORING MACHINE

Before storing the machine for an extended time, the machine needs to be serviced to lessen the chance of rust, sludge, and other undesirable deposits from forming.

SPECIFICATIONS

SPECIFICATIONS

GENERAL MACHINE DIMENSIONS/CAPACITIES

Item	Dimension/capacity	
Length	1520 mm	(60 in)
Width	805 mm	(32 in)
Height	1180 mm	(46 in)
Track	880 mm	(35 in)
Wheelbase	682 mm	(27 in)
Main sweeping brush diameter	280 mm	(11 in)
Main sweeping brush length	560 mm	(22 in)
Side brush diameter	406 mm	(16 in)
Sweeping path width	560 mm	(22 in)
Sweeping path width with one side brush	762 mm	(30 in)
Sweeping path width with two side brushes	965 mm	(38 in)
Main sweeping brush pattern width	50 mm	(2 in)
Hopper weight capacity	90 kg	(200 lb)
Hopper volume capacity	85 L	(3 cu ft)
Dust filter area	3.2 sq m	(34 sq ft)
GVWR	458 kg	(1009 lb)

GENERAL MACHINE PERFORMANCE

Item	Measure	
Maximum forward speed	8 km/h	(5 mph)
Maximum reverse speed	4.8 km/h	(3 mph)
Minimum turning radius	1829 mm	(72 in)
Maximum rated incline with empty hopper	10°	
Maximum rated incline with full hopper	8°	

POWER TYPE

Type	Quantity	Volts	Ah Rating	Weight
Batteries	6	6	220 @ hr rate	177 kg (390lbs)

Type	Use	VDC	Kw (hp)
Electric Motor (S/N 000000-002362)	Propelling	36	.56 (.75 hp)
Electric Motor (S/N 002363-)	Propelling	36	1.0 (1.34 hp)

Type	VDC	A	Hz	Phase	VAC
Charger	36	20	60	1	240

STEERING

Type	Power source	Emergency steering
Front wheel, manual controlled	Manual steering	Manual

BRAKING SYSTEM

Type	Operation
Service brakes	Mechanical disc brake (1), one front wheel, cable actuated
Parking brake	Utilizes service brakes, cable actuated

TIRES

Location	Type	Size
Front (1) (S/N 000000-002362)	Solid	90 x 305 mm (3.5 in x12 in OD)
Front (1) (S/N 002363-)	Solid	90 x 250 mm (3.5 in x 9.8 in OD)
Rear (2)	Solid	75 x 305 mm (3 in x 12 in OD)

SPECIFICATIONS

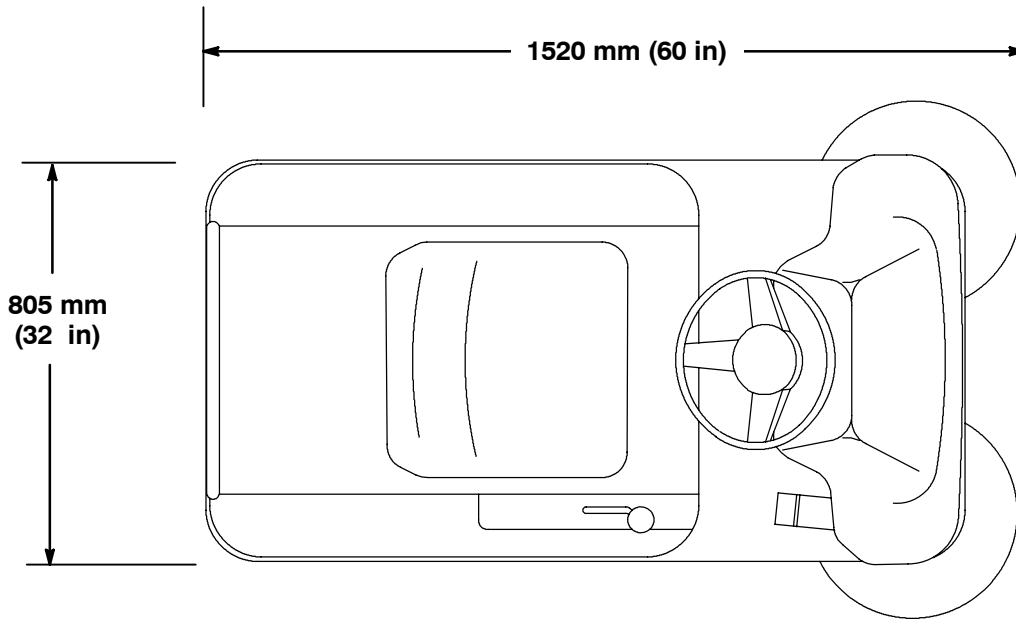

TOP VIEW

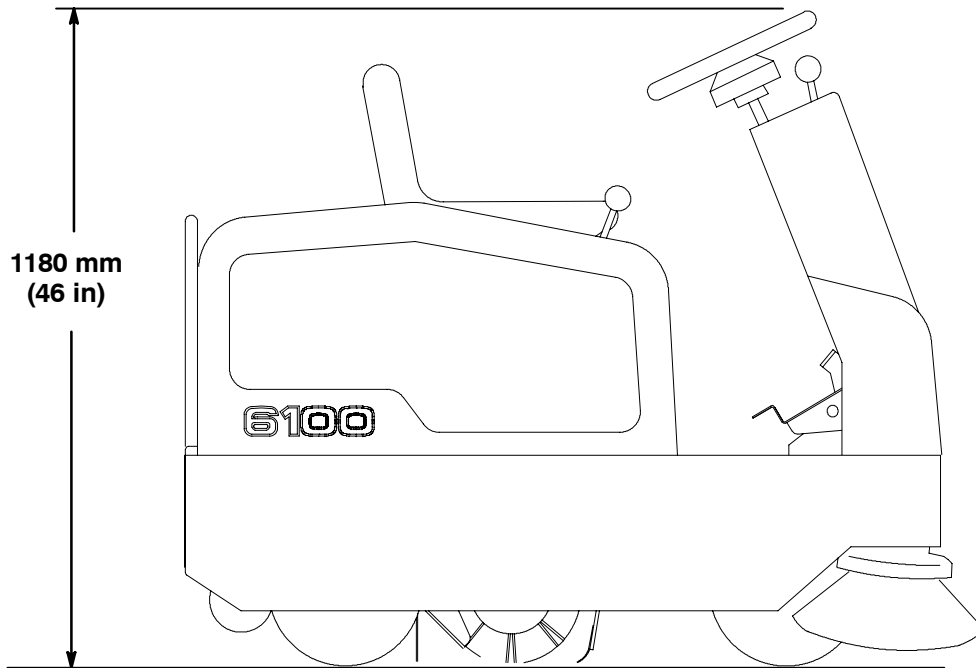

SIDE VIEW

MACHINE DIMENSIONS

352185

- A**
- Aisle turn, 68
- B**
- Batteries, 42–46
 Charger specifications, 69
 Charging, 43–46
 Discharge indicator, 12
 Maintenance, 42
 Rollout Battery Option, 33
 Specifications, 69
- Battery discharge indicator, 12
- Belts, 46
 Main brush, 46
 Vacuum Fan, 46
- Brake adjustment, 61
- Brake pedal, 10
- Battery Connections, 18
- Brakes, 18, 61
 System specifications, 69
- Brush door seals, 59, 60
- Brushes, 21–24, 28, 54–59
 Adjusting main brush taper, 56
 Adjusting side brush pattern, 57
 Checking main brush pattern, 55–57
 Checking side brush pattern, 57
 Door seals, 59, 60
 Main brush, 21, 54–57
 Main brush bristle length, 54
 Main brush lever, 11
 Rear skirts, 59
 Replacing main brush, 54–56
 Replacing side brush, 58
 Side brush, 22, 57–59
 Side brush bristle length, 57
 Side brush guard, 58
 Side brush lever, 13
- Button, Horn, 13
- C**
- Capacities, 68
- Chains, 46
 Propelling, 40, 46
 Static drag, 47
 Steering gear chain, 40, 47
- Circuit breakers, 15
- Control panel
 Battery discharge indicator, 12
 Hourmeter, 12
 Operating lights switch, 14
 Operating/hazard lights switch, 14
- Controls, 8
 Battery discharge indicator, 12
 Brake pedal, 10
 Circuit breakers, 15
 Directional pedal, 9
 Fuse, 15
 Horn button, 13
 Hourmeter, 12
 Large debris trap pedal, 10
 Main brush lever, 11
 Main brush vacuum and filter shaker switch, 11
 On-off key switch, 13
 Operating lights switch, 14
 Operating/hazard lights switch, 14
 Operation, 9
 Parking brake pedal, 10
 Power kill switch, 11
 Side brush lever, 13
 Steering wheel, 12
 Symbols, 7–9
- D**
- Debris hopper, 48–50
- Dimensions, 68
- Directional pedal, 9
- Doors, Brush, Seals, 59, 60
- Dust filter
 Changing, 49–51
 Cleaning, 48
- E**
- Electric motors, 46, 69
- Electrical
 Batteries, 42–46
 Charging batteries, 43–46
 Circuit breakers, 15
 Fuse, 15
 On-off key switch, 13
- Emptying the hopper, 27–30
- F**
- Fuses, 15

H

Hopper
 Changing dust filter, 49–51
 Cleaning dust filter, 48
 Debris, 48–50
 Dust filter, 48–50
 Emptying the hopper, 27–30
 Seals, 60
Hopper , 17
Hopper filter, 48–50
Hopper seals, 60
Horn button, 13
Hourmeter, 12
How the machine works, 18

J

Jack points, 67
Jacking up the machine, 67

L

Large debris trap pedal, 10
Large debris trap skirt, 60
Levers
 Main brush, 11
 Side brush, 13
Lights
 Operating lights switch, 14
 Operating/hazard lights switch, 14
Lubrication, 40–42
 Propelling system, 40, 46
 Steering caster pivot bearing, 41
 Steering castor pivot bearing, 41
 Steering gear chain, 40, 47

M

Machine, Troubleshooting, 37
Machine components, 6
Machine dimensions, 70
Machine jacking, 67
Machine tie down location, 66

Main brush, 21, 54–57
 Adjust brush taper, 56
 Belt, 46
 Bristle length, 54
 Checking brush pattern, 55–57
 Door seals, 59, 60
 Hopper seals, 60
 Maintenance, 54
 Rear skirts, 59
 Replacing, 54–56
Main brush belt, 46
Main brush lever, 11
Main brush, vacuum and filter shaker switch, 11
Maintenance, 38
 Intervals, 38–40
Maintenance chart, 38–40
Motors, Electric, 46, 69

O

On-off key switch, 13
Operating lights switch, 14
Operating/hazard lights switch, 14
Operation
 QuickMop, 31
 Rollout Battery, 33
 Vacuum Wand, 29
Operation on inclines, 20
Operator Responsibility, 5
Operator Seat, 16
Operator seat, 16
Operator seat safety switch, 16
Option, Operator seat, Adjustment, 16
Options, 29–31
 Operating lights switch, 14
 Operating/hazard lights switch, 14
 QuickMop, 31
 Rollout Battery, 33
 Vacuum Wand, 29

P

Parking brake pedal, 10
 Pedal, Directional, 9
 Pedals
 Brake, 10
 Large debris trap pedal, 10
 Parking brake, 10
 Post-operation checklist, 28
 Power kill switch, 11
 Pre-operation checklist, 18
 Propelling gearbox, 40, 46
 Pushing machine, 64
 Pushing or towing the machine, 64
 Pushing, towing, and transporting machine, 64

Q

QuickMop Option, 31

R

Rear skirts, 59
 Rollout Battery Option, 33

S

Operation, 5
 Hopper, 17
 Safety
 Labels, 4
 Precautions, 3–5
 Seals, 59–62
 Brush doors, 59, 60
 Seat
 Adjustment, 16
 Operator, 16
 Operator safety switch, 16
 Service records, 28
 Side brush, 22, 57–59
 Adjusting, 57
 Bristle length, 57
 Checking brush pattern, 57
 Guard, 58
 Lever, 13
 Replacing, 58
 Side brush guard, 58
 Side brush lever, 13
 Skirts, 28, 59–62
 Large debris trap, Seals, 60
 Rear, 59
 Specifications, 68–71
 Braking system, 69
 Chargers, 69
 Electric motors, 69
 Machine capacities, 68
 Machine dimensions, 68
 Machine performance, 68
 Power type, 69
 Steering, 69
 Tires, 69
 Starting the machine, 19
 Static drag chain, 47
 Battery charger, 18
 Steering, 18
 Specifications, 69
 Steering castor pivot bearing, 41
 Steering gear chain, 40, 47
 Steering wheel, 12
 Stop sweeping, 25
 Stop the machine, 26
 Storing machine, 67
 Sweeping, 23
 Sweeping and brush information, 21–24
 Switches
 Main brush vacuum and filter shaker, 11
 On-off key, 13
 Operating lights, 14
 Operating/hazard lights, 14
 Power kill, 11

T

Tie down location, 66

Tires, 61, 63
Specifications, 69

Towing machine, 64

Transporting machine, 64

Transporting the machine, 64

Travel speed, 68

Troubleshooting, 37

U

Upper hopper seals, 60

V

Vacuum fan, Belt, 46

Vacuum fan belt, 46

Vacuum Wand Option, 29