



Electronic Service Manuals

This electronic document is provided as a service to our customers. We do not create the contents of the information contained in this document. Should you have detailed questions pertaining to the information contained in this document, you may contact Michco, or the manufacturer which provided the original information in this electronic deliverable. Michco's only part in this electronic deliverable was the electronic assembly process.

You may contact Michco through the following methods:
Phone (517) 484-9312 or (800) 331-3339 MI, OH, IN only
2011 N. High St. -- Lansing, Michigan -- 48906
Fax: (517) 484-9836
Email: CustServ@Michco.com
Web site: www.Michco.Com
Parts Web site: www.FloorMachineParts.Com

Order Parts on Line at:
www.FloorMachineParts.Com

Directly to Parts & Service:
By Email: **Shop@Michco.com**
By Fax: (517) 702-2041
By Voice: Use numbers above.

Serving the Cleaning Industry Since 1922

Notice: All copyrighted material remains property of original owners, all trademarks are property of respective owners. Manuals are subject to Manufacturer's reproduction limitations. Originals or reproductions were provided by manufacturers through a request. We make no warranty as to the correctness of information provided in this document and you assume all risk.

Carpet Blower

Model: C44000-01 (115V)
C44000-02 (230V)

■ OPERATION ■ SERVICE ■ PARTS ■ CARE

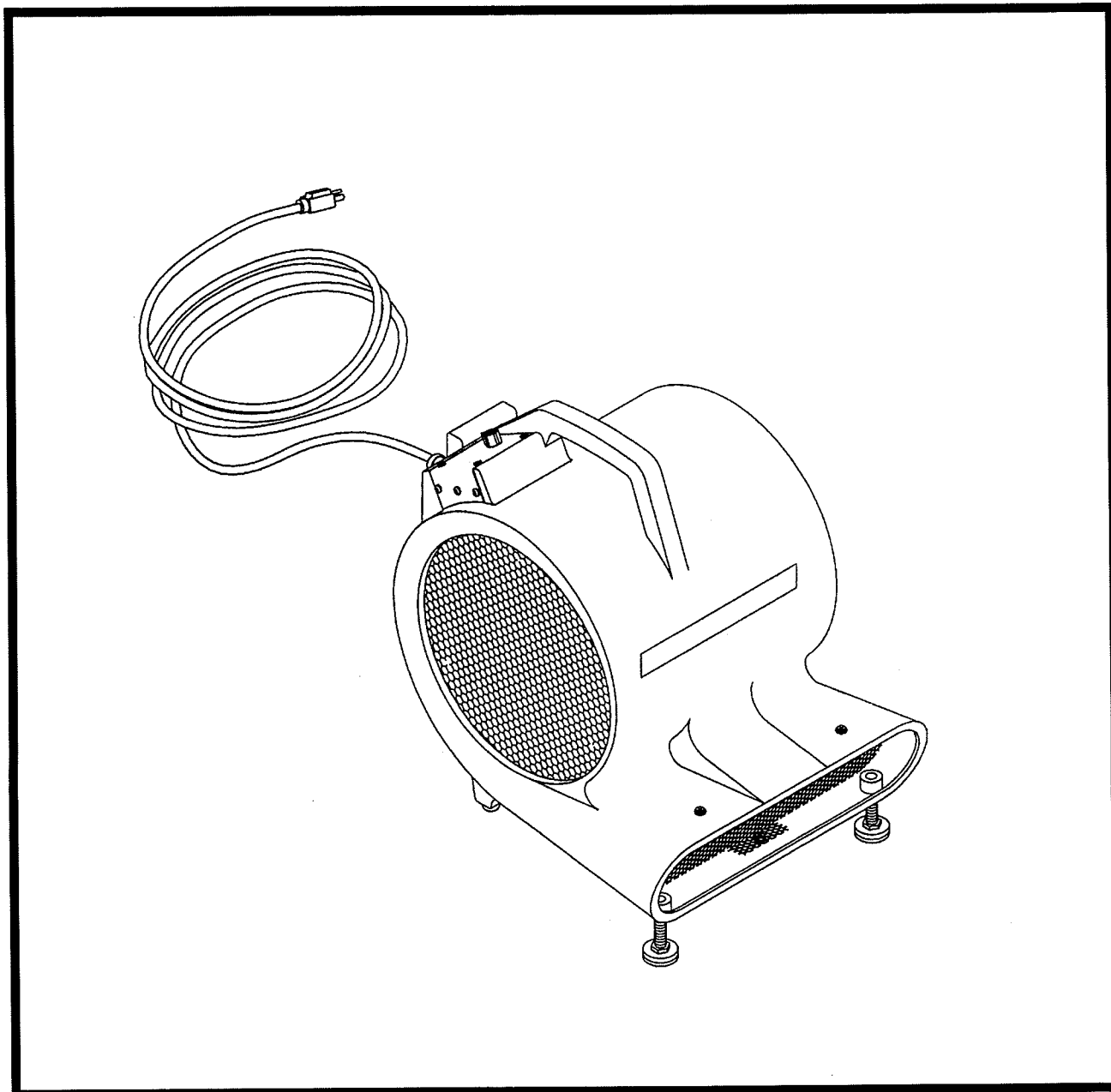

Revised 5/01

Minuteman[®]

EC Declaration of Conformity

according to Directives 72/23, 89/392, and 89/336

We, Minuteman International Incorporated, of 111 South Rohlwing Road Addison Illinois 60101 USA, declare under our sole responsibility that the product C44000-02 Commercial Carpet Blower to which this declaration relates corresponds to the relevant requirements of the EC Directives 72/23, 89/392 and 89/336. The following standards were used to determine compliance with the Directives: EN 292, EN 294, EN 811, EN 55014, EN 55104 and EN 60335-1.

SOUND		VIBRATION												
72 dB Operator	68dB At 3m	5.0 m/s² At Operators Handle												
<p>Tests were conducted on 12/18/96 with calibrated sound and vibration equipment under the conditions noted below:</p> <table style="width: 100%; border: none;"> <tr> <td style="width: 33%;">General Condition:</td> <td style="width: 33%;">Indoors</td> <td style="width: 33%;">Wind:</td> <td style="width: 33%;">0 km/hr</td> </tr> <tr> <td>Temperature:</td> <td>25^oC</td> <td>Humidity:</td> <td>70%</td> </tr> <tr> <td>Barometric Pressure:</td> <td>29.5</td> <td></td> <td></td> </tr> </table>			General Condition:	Indoors	Wind:	0 km/hr	Temperature:	25 ^o C	Humidity:	70%	Barometric Pressure:	29.5		
General Condition:	Indoors	Wind:	0 km/hr											
Temperature:	25 ^o C	Humidity:	70%											
Barometric Pressure:	29.5													

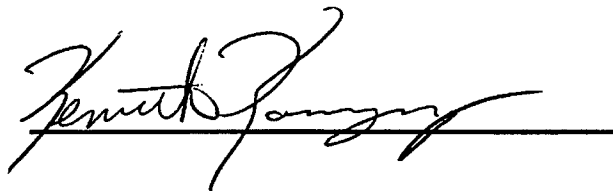

Kenneth Kaczmarz, Standards Engineer

12/18/96

Date

FOR COMMERCIAL USE ONLY

IMPORTANT SAFETY INSTRUCTIONS

When using an electrical appliance, basic precautions should always be followed, including the following:

READ ALL INSTRUCTIONS BEFORE USING

WARNING - To reduce the risk of fire, electric shock, or injury:

- Do not leave appliance when plugged in. Unplug from outlet when not in use and before servicing.

WARNING

To avoid electrical shock, do not use outdoors. Do not operate in standing water.

- Do not allow to be used as a toy. Close attention is necessary when used by or near children.
- Use only as described in this manual. Use only manufacturer's recommended attachments.
- Do not use with damaged cord or plug. If appliance is not working as it should, has been dropped, damaged, left outdoors, or dropped into water, return it to a service center. If the cord is damaged, it must be replaced by the manufacturer or its service agent or a similarly qualified person in order to avoid a hazard.
- Do not pull or carry by cord, use cord as a handle, close a door on cord, or pull cord around sharp edges or corners. Do not run appliance over cord. Keep cord away from heated surfaces.
- Do not unplug by pulling on cord. To unplug, grasp the plug, not the cord.
- Do not handle plug or appliance with wet hands.
- Do not put any object into openings. Do not use with any opening blocked; keep free of dust, lint, hair, and anything that may reduce air flow.
- Keep hair, loose clothing, fingers, and all parts of body away from openings and moving parts.
- Do not pick up anything that is burning or smoking, such as cigarettes, matches, or hot ashes.
- Do not use without dustbag and/or filters in place.
- Turn off all controls before unplugging.
- Use extra care when cleaning on stairs.
- Do not use to pick up flammable or combustible liquids such as gasoline or use in areas where they may be present.
- Connect to a properly grounded outlet only. See grounding instructions.

SAVE THESE INSTRUCTIONS

INSPECTION

Carefully unpack and inspect your machine for shipping damage. Each unit is tested and thoroughly inspected before shipment, and any damage is the responsibility of the delivery carrier who should be notified immediately.

ELECTRICAL - 115 Volt

This machine is designed to operate on a standard 15 amp., 115 volt, 60 hz, AC circuit. Voltages below 105 volts AC or above 125 volts AC could cause serious damage to the motor.

ELECTRICAL - 230 Volt

This machine is designed to operate on a standard 10 amp., 230 volt, 50 hz, AC circuit.

WARNING

Electric motors can cause explosions when operated near explosive materials or vapors. Do not operate this machine near flammable materials such as solvents, thinners, fuels, grain dust, etc.

GROUNDING INSTRUCTIONS

This appliance must be grounded. If it should malfunction or breakdown, grounding provides a path of least resistance for electric current to reduce the risk of electric shock. This appliance is equipped with a cord having an equipment-grounding conductor and grounding plug. The plug must be plugged into an appropriate outlet that is properly installed and grounded in accordance with all local codes and ordinances.

DANGER - Improper connection of the equipment-grounding conductor can result in a risk of electric shock. Check with a qualified electrician or service person if you are in doubt as to whether the outlet is properly grounded. Do not modify the plug provided with the appliance — if it will not fit the outlet, have a proper outlet installed by a qualified electrician.

This machine is for use on a nominal 120 volt circuit and has a grounding plug that looks like the plug illustrated in Sketch A. Make sure that the machine is connected to an outlet having the same configuration as the plug. No adapter should be used with this appliance.

For equipment rated 150-250 volts: If the machine is provided with an attachment plug as shown in Sketch B, it is intended for use on a 240 volt (nominal) circuit. No adapter is available for this plug.

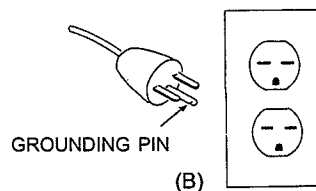
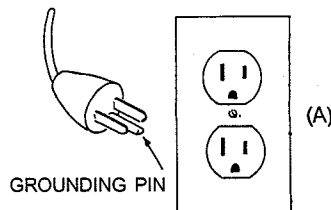

POUR USAGE COMMERCIAL SEULEMENT

MODE D'EMPLOI SECURITAIRE

Lorsque l'on utilise un appareil électrique, des précautions de base doivent toujours être suivies telles que:

BIEN LIRE LE MODES D'EMPLOI AVANT USAGE

AVERTISSEMENT - Pour réduire les risques de feu, choc électrique ou blessure:

- Ne pas quitter l'appareil lorsque la prise de courant est branchée. Débrancher de la sortie électrique lorsque la machine n'est pas en usage ou pour en faire le service.

AVERTISSEMENT - Pour éviter des chocs électriques, ne pas utiliser à l'extérieur, ne pas opérer si l'unité est déposée sur une surface humide.

- Ne pas permettre l'usage comme jouet. Etre très prudent lorsque l'appareil est utilisé en présence d'enfants.
- Utiliser tel que prescrit dans le livre d'opération et seulement avec les attachements recommandés par le fabricant.
- Ne pas s'en servir avec corde ou prise de courant endommagée. Si l'appareil ne fonctionne pas ou a été échappé, endommagé, entreposé à l'extérieur ou déposé dans l'eau, l'appareil devrait être envoyé à un département de service pour inspection.
- Ne pas tirer ou porter par le câble ou se servir du câble comme poignée. Ne pas fermer de portes sur le câble ou tirer le câble près d'objets pointus. Ne pas conduire l'appareil en écrasant le câble et soyez certain de protéger le câble entre toutes surfaces de chauffage.
- Ne pas débrancher en se servant du câble. Pour débrancher tirer sur la prise et non sur le câble.
- Ne pas manipuler la prise ou l'appareil avec les mains mouillées.
- Ne placer aucun objet dans la sortie et ne pas s'en servir si la sortie est obstruée. Eliminer toute poussière, maillon, cheveux ou quoique ce soit qui pourrait réduire le mouvement d'air.
- N'exposer aucun cheveux, vêtement, doigts ou autres aux ouvertures de l'appareil.
- Ne rien ramasser de ce qui brûle ou de fumée tels que cigarettes, allumettes ou cendres en feu.
- Ne pas employer sans filtre de poussière ou autre en position.
- Fermer tous les contrôles après utilisation.
- Soyez très prudent lors du nettoyage d'escaliers.
- Ne pas ramasser de liquide inflammable ou combustible tel que gazoline et ne pas utiliser dans les endroits où ces derniers pourraient être présents.
- Brancher dans une prise avec une prise de terre seulement. Voir références pour prise de terre.

**CONSERVEZ CES RECOMMANDATIONS
DE MODE D'EMPLOI**

INSPECTION

Déballer soigneusement et inspecter la possibilité de tout dommage apparent. Chaque machine est complètement inspectée à l'usine et les dommages de transit sont la responsabilité de la compagnie de transport qui devrait être prévenue immédiatement.

ELECTRICITE

Cette machine est conçue pour opérer sur un circuit standard de 15 amp. 115 volt, 60 hz, circuit AC. Tous voltages en bas de 105 volts AC ou au delà de 125 volts AC pourrait occasionner des dommages au moteur.

AVERTISSEMENT

Les moteurs électriques peuvent être la cause d'explosion si utilisés près de matériaux ou vapeurs explosifs. Ne pas opérer près de matériaux inflammables tels que solvant, gazolines, poussière de grain etc.

INSTRUCTIONS POUR PRISSE DE TERRE

Cet appareil doit posséder une prise de terre, S'il y avait malfonction ou brisure, une prise de terre offre une voie de moindre résistance de façon à ce que le courant électrique réduise le risque de choc. Cet appareil est équipé d'une prise de terre de même qu'une prise de courant avec prise de terre. Cette prise doit être déposée dans une sortie adéquate qui sera installée selon les exigences et les lois locales.

DANGER - Un mauvais assemblage du conducteur de prise de terre pourrait causer un risque de choc électrique. Vérifier auprès d'un électricien certifié ou d'une personne qualifiée si vous avez des doutes à savoir si la prise est bien complétée. Ne pas modifier la prise qui vient avec cet appareil. Si la prise n'accède pas à la sortie, un électricien qualifié devrait la remplacer.

Cet appareil doit être utilisé sur un circuit de nominal de 115/120 volt et posséder une prise de terre qui ressemble à la prise illustrée dans le schéma A. Bien vous assurer que la sortie de courant soit de la même configuration que la prise. Aucun adaptateur ne doit être utilisé avec cet appareil.

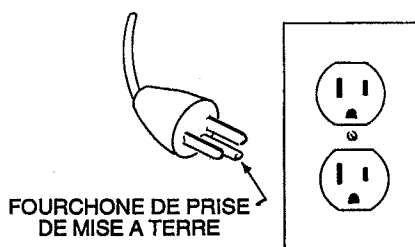

(A)

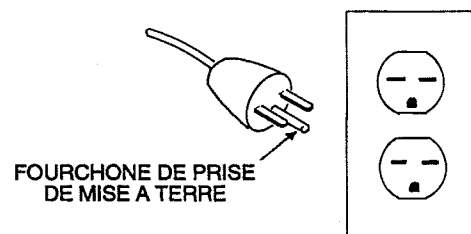

(B)

115V Model

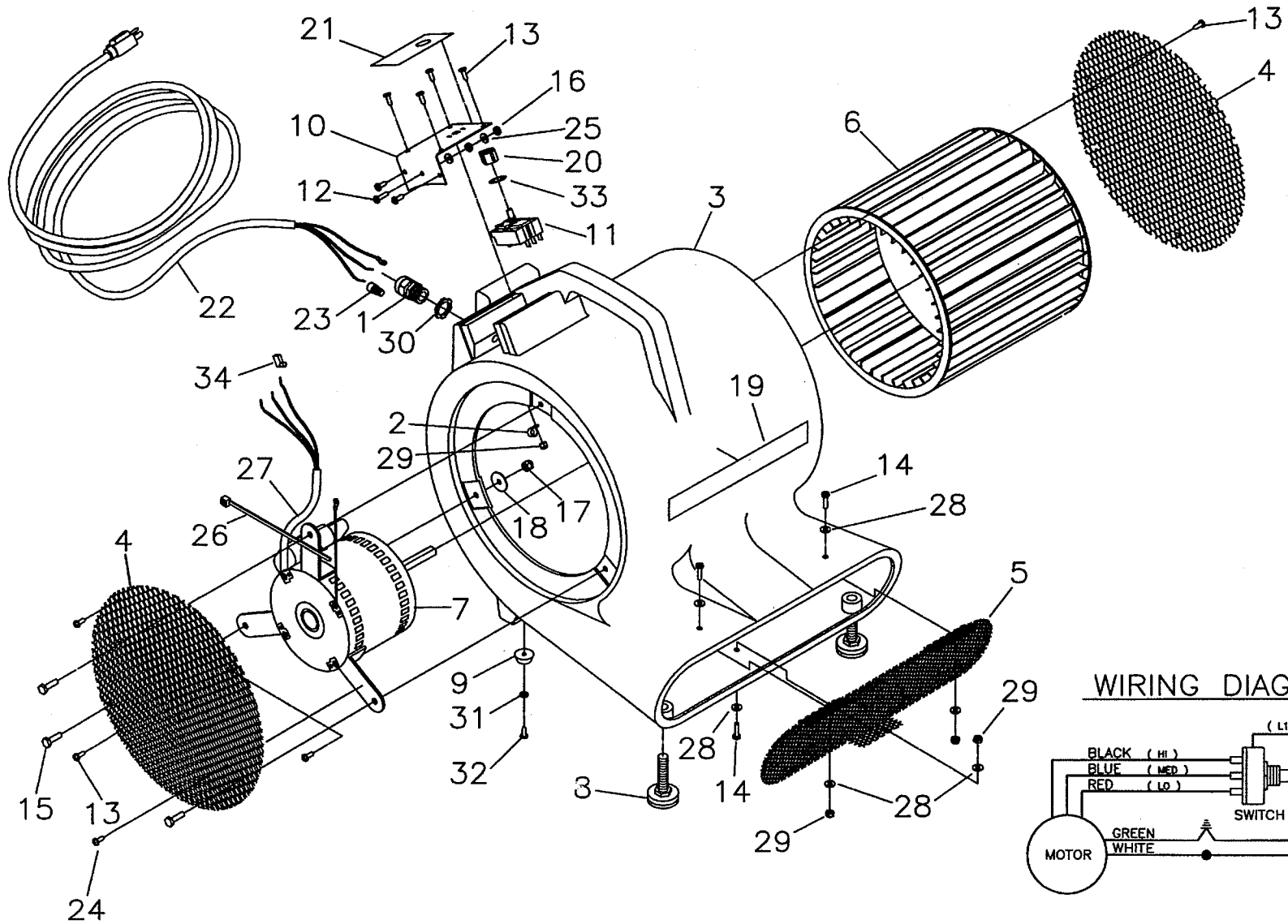

WIRING DIAGRAM

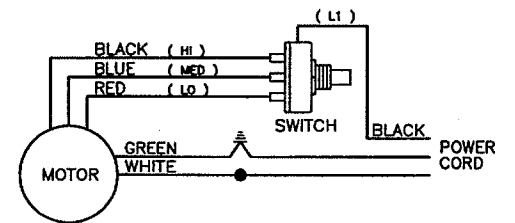

Parts List

ITEM NO.	PART NO.	QUANTITY	DESCRIPTION
1	450050	1	Plastic Strain Relief
2	250039	1	5/16" ID Plastic Cable Clamp
3	440000	1	Blower Housing, Black
4	440001	2	Housing Side Screen
5	440003	1	Front Screen Finger Guard
6	440005	1	Blower Cage
7	440021	1	3-Speed 100/115V Motor
8	440016	2	Height Adjuster
9	440010	2	Rubber Grommet
10	440025	1	Switch Faceplate
11	742315	1	Switch (off + 3 positions)
12	710356	1	Screw, MC 10-32 x .63 STPL
13	711104	17	Screw, ST Type A #10 x .50
14	710357	3	SCR-MC 10-32 X .75 STPL
15	711206	3	HH-Bolt 1/4-20 x .88 STPL
16	711310	2	Hex Nut #10-32
17	711373	3	Nyloc Hex Nut 1/4-20
18	711519	7	Flat Washer .25 x 1.00 x .06
19	715385	1	Decal, "Minuteman"
20	809875	1	Knob
21	715241	1	Decal Faceplate Warning
22	740705	1	Power Cord 100/115V
23	740006	5	Wire Cap, Orange
24	710188	3	Screw 1/4 X 3/4 Self Drill
25	711553	2	Lock Washer #10
26	828062	1	Large Cable Tie
27	833923	4	3/8" ID Heat Shrink
28	710503	6	WSR-Flat #10
29	711350	1	Nylock Nut 10-32
30	711400	1	Locking Nut 1/2 NPT
31	712320	2	Nylon Washer
32	711106	2	SCR-ST-A 10 X .75 PL
33	711556	1	3/8 Int. Tooth Lock Washer
34	740018	4	Terminal, FM Spade 16-14 GA

Parts List

ITEM NO.	PART NO.	QUANTITY	DESCRIPTION
1	450050	1	Plastic Strain Relief
2	250039	1	5/16" ID Plastic Cable Clamp
3	440000	1	Blower Housing
4	440001	1	Housing Side Screen
5	440003	1	Front Screen Finger Guard
6	440005	1	Blower Cage
7	440007	1	3-Speed 240V Motor
8	440016	2	Height Adjuster
9	440010	2	Rubber Grommet
10	440025	1	Switch Faceplate
11	742315	1	Switch (off + 3 positions)
12	710356	1	Screw, MC 10-32 x .63 STPL
13	711104	17	Screw, ST Type A #10 x .50
14	710357	3	SCR-MC 10-32 X .75 STPL
15	711206	3	HH-Bolt 1/4-20 x .88 STPL
16	711310	2	Hex Nut #10-32
17	711373	3	Nyloc Hex Nut 1/4-20
18	711519	7	Flat Washer .25 x 1.00 x .06
19	715385	1	Decal "Minuteman"
20	809875	1	Knob
21	715241	1	Decal Faceplate Warning
22	742385	1	Power Cord 230V
23	740006	5	Wire Cap, Orange
24	710188	3	Screw 1/4 X 3/4 Self Drilling
25	711553	2	Lock Washer #10
26	828062	1	Large Cable Tie
27	833923	4	3/8" ID Heat Shrink
28	711503	6	WSR-Flat #10
29	711350	1	Nyloc Nut 10-32
30	711400	1	Locking Nut 1/2 NPT
31	712320	2	Nylon Washer
32	711106	2	SCR ST-A 10 X .75
33	711555	1	3/8 Int. Tooth Lock Washer
34	740018	4	Terminal, FM Spade 16-14 GA
35	440033	1	Side Screen Weldment

LIMITED WARRANTY

Minuteman International, Inc. warrants to the original purchaser/user that this product is free from defects in workmanship and materials under normal use and service for a period of one year from date of purchase. In addition, Minuteman International, Inc. will, at its option, honor labor warranty claims for the first 12 months from date of sale, provided such claims are submitted through and approved by factory authorized repair stations. Minuteman International, Inc. will, at its option, repair or replace without charge, except for transportation costs, parts that fail under normal use and service when operated and maintained in accordance with the applicable operation and instruction manuals.

This warranty does not apply to normal wear, or to items whose life is dependent on their use and care, such as belts, cords, switches, hoses, rubber parts, electrical motor components or adjustments. Parts not manufactured by Minuteman International, Inc. such as engines, batteries, battery chargers, hydraulic pumps, and tires are covered by and subject to the warranties and/or guarantees of their manufacturers. Please contact Minuteman International, Inc. for procedures in warranty claims against these manufacturers.

Special warning to purchaser — Use of replacement filters and/or prefilters not manufactured by Minuteman International, Inc. or its designated licensees, will void all warranties expressed or implied.

A potential health hazard exists without exact original equipment replacement.

All warranted items become the sole property of Minuteman International, Inc. or its original manufacturer, whichever the case may be.

Minuteman International, Inc. disclaims any implied warranty, including the warranty of merchantability and the warranty of fitness for a particular purpose. Minuteman International, Inc. assumes no responsibility for any special, incidental or consequential damages.

This limited warranty is applicable only in the U.S.A. and Canada, and is extended only to the original user/purchaser of this product. Customers outside the U.S.A. and Canada should contact their local distributor for export warranty policies. Minuteman International, Inc. is not responsible for costs or repairs performed by persons other than those specifically authorized by Minuteman International, Inc. This warranty does not apply to damage from transportation, alterations by unauthorized persons, misuse or abuse of the equipment, use of non-compatible chemicals, or damage to property, or loss of income due to malfunctions of the product.

If a difficulty develops with this machine, you should contact the dealer from whom it was purchased.

This warranty gives you specific legal rights, and you may have other rights which vary from state to state. Some states do not allow the exclusion or limitation of special, incidental or consequential damages, or limitations on how long an implied warranty lasts, so the above exclusions and limitations may not apply to you.

Minuteman[®]

World Headquarters
Minuteman International, Inc.
111 South Rohlwing Road
Addison, Illinois 60101

Minuteman Canada, Inc.
2210 Drew Road
Mississauga, Ontario
L5S 1B1

(630) 627-6900
FAX (630) 627-1130

(905) 673-3222
FAX (905) 673-5161

987318 5/01
Printed in U.S.A.