



Electronic Service Manuals

This electronic document is provided as a service to our customers. We do not create the contents of the information contained in this document. Should you have detailed questions pertaining to the information contained in this document, you may contact Michco, or the manufacturer which provided the original information in this electronic deliverable. Michco's only part in this electronic deliverable was the electronic assembly process.

You may contact Michco through the following methods:
Phone (517) 484-9312 or (800) 331-3339 MI, OH, IN only
2011 N. High St. -- Lansing, Michigan -- 48906
Fax: (517) 484-9836
Email: CustServ@Michco.com
Web site: www.Michco.Com
Parts Web site: www.FloorMachineParts.Com

Order Parts on Line at:
www.FloorMachineParts.Com

Directly to Parts & Service:
By Email: **Shop@Michco.com**
By Fax: (517) 702-2041
By Voice: Use numbers above.

Serving the Cleaning Industry Since 1922

Notice: All copyrighted material remains property of original owners, all trademarks are property of respective owners. Manuals are subject to Manufacturer's reproduction limitations. Originals or reproductions were provided by manufacturers through a request. We make no warranty as to the correctness of information provided in this document and you assume all risk.



Advance PowerOne|12|15

by Nilfisk-Advance

**COMMERCIAL
SINGLE MOTOR UPRIGHT VACUUM CLEANER**

PowerOne 12 Model: 56704300 V.120/60

PowerOne 15 Model: 56704301 V.120/60

**OPERATOR MANUAL AND PARTS LIST
ISTRUZIONI PER L'USO E LISTA DELLE PARTI DI RICAMBIO
BEDIENUNGSANWEISUNG UND ERSATZTEILLISTE
MODE D'EMPLOI ET PIÈCES DE RECHANGE
INSTRUCCIONES PARA EL USO Y PIEZAS DE RECAMBIO**

Revised 05/02 Form Number
56041513

TABLE OF CONTENTS	INDICE	INHALTSVERZEICHNIS	INDEX	INDICE
Important safety instructions 3	Norme di sicurezza 3	Zur besonderen Beachtung 3	Consignes des sécurité 3	Instrucciones importantes de seguridad 3
Grounding instructions	Protettore Thermo/amperometrico del motore aspirante 4	Thermo/Amperemeterschutz des Saugmotors 4	Protecteur Thermo/Ampèremetrique du moteur aspirant 4	Protector Thermo/Amperimétrico para proteccion motor aspirante 4
Thermal vacuum motor protector 4	Conoscere la vostra macchina 5	Ihre Maschine kennenlernen 5	Pour connaître votre machine 5	Conozca su máquina 5
Know your machine 5	Messa in funzione 6	Die Maschine in Betrieb setzen 6	Montage 6	Instrucciones para el montaje 6
Assembly instructions 6	Istruzioni per il funzionamento 6	Bedienung der Maschine 6	Mise en service de la machine 6	Instrucciones de funcionamiento 6
Operating instructions 6	Regolazione spazzola 7	Saugbürsten- Höhenverstellung 7	Réglage de la brosse 7	Regulación del cepillo 7
Brush adjustment 7	Manutenzione 8 - 9	Wartung 8 - 9	Entretien 8 - 9	Mantenimiento 8 - 9
Maintenance 8 - 9	Sostituzione del rullo 10	Auswechseln der Bürste 10	Changement du rouleau 10	Substitución del rodillo 10
Changing the brush roller 10	Lista ricambi 11-12	Ersatzteilliste 11-12	Liste pièces de rechange 11-12	Lista recambios 11-12
Parts list 11-12	Garanzia 11-12	Garantie 11-12	Garantie 11-12	Garantía 11-12
Warranty 11-12				
RECORD THE MODEL AND SERIAL NUMBER OF YOUR MACHINE AND KEEP FOR FUTURE REFERENCE.	REGISTRATE IL MODELLO E IL NUMERO DI SERIE DELLA VS MACCHINA E CUSTODITE PER FUTURE REFERENZE.	SCHREIBEN SIE SICH HIER DIE SERIENNUMMER UND DEN MODELLTYP AUF.	MARQUER CI-DESSOUS LE MODÈLE ET LE NUMÉRO DE SÉRIE ET LE GARDER COMME RÉFÉRENCE.	RECUERDE EL MODELO Y EL N° DE SERIE DE SU MÁQUINA, GUÁRDELO COMO REFERENCIA PARA EL FUTURO.
MODEL NUMBER _____	MODELLO _____	MODELLTYP _____	MODÈLE _____	MODELO _____
SERIAL NUMBER _____	NUMERO DI SERIE _____	SERIENNUMMER _____	NUMÉRO DE SERIE _____	N° SERIE _____



Nilfisk-Advance, Inc.
14600 21st Avenue North
Plymouth, MN, 55447-3408
www.nilfisk-advance.com
Phone: 800-989-2235
Fax: 800-989-6566

©1999 Nilfisk-Advance, Inc.,
Plymouth, MN 55447-3408

SPECIFICATIONS DATI TECNICI TECHNISCHE DATEN
CARACTERISTIQUES TECHNIQUES CARACTERÍSTICAS TÉCNICAS

Model		PowerOne 12	PowerOne 15
Voltage	V/Hz	120/60	120/60
Rated Power	W	850	850
Protection Class (electrical)		I	I
Sound Pressure Level	db(A)/20µPa	69	69
Total Weight	lbs / Kg	15 / 6.8	15.3 / 6.95
Vibrations at the Hand Controls	m/s ²	<2.5 m/s ²	<2.5 m/s ²

APPROVALS - APPROVAZIONI - BILLIGUNG - APPROBATIONS - APROVACIONES

U.S.A. and Canada ETL



WARNING

This machine is not intended for use with hazardous materials. Doing so may expose people to serious health risks.

56015112

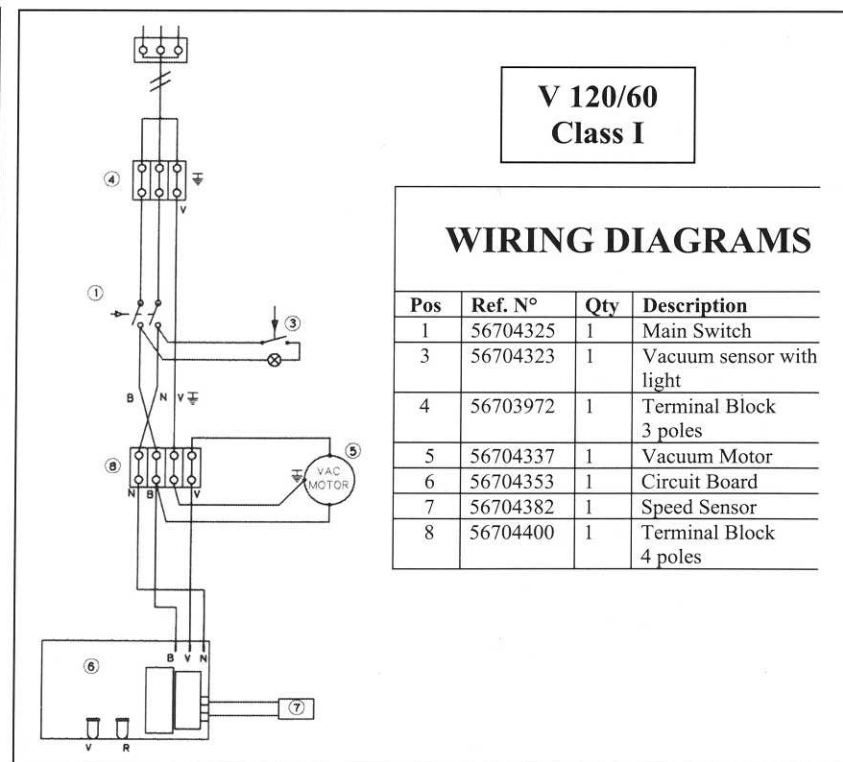

WHEN USING AN ELECTRICAL APPLIANCE, BASIC PRECAUTIONS SHOULD ALWAYS BE FOLLOWED, INCLUDING THE FOLLOWING

IMPORTANT SAFETY INSTRUCTIONS

Read these operating instructions carefully

- Do not use on any wet surface.
- **Always disconnect the plug when the machine is not in use and before doing any maintenance or cleaning of the machine.**
- The plug should not be subjected to undue stress by pulling on the power supply cable.
- Do not leave the machine unattended when it is on and don't allow the machine to be used as a toy.
- Do not use where there are unsupervised young children.
- Always keep hands, hair, feet and clothes away when the machine is on.
- Do not vacuum over electrical cord, it becomes damaged and creates an electrical hazard. If the machine appears to be faulty, do not use it. Return it to your authorized dealer for service.
- Do not suck up matches, ash or cigarettes that are still burning
- Do not suck up inflammable liquid materials or any other liquid material.
- Avoid vacuuming hard or sharp objects or damage may result.
- Use the machine only for what it is meant for, and as described in the instructions.
- Do not switch on again a machine which seems to be faulty.
- Use and keep this machine in a dry environment and at a temperatures between +5°C + +35°C (+41°F + +95°F)
- Do not expose to the sun and UV rays

QUANDO SI USANO APPARECCHI ELETTRICI, DEVONO ESSERE SEGUITE NORMALI PRECAUZIONI, INCLUSE LE SEGUENTI

NORME DI SICUREZZA

Leggere attentamente il manuale di istruzioni

- Non usare la macchina su superfici bagnate.
- **Staccare sempre la spina dalla presa di corrente quando l'apparecchio non è in uso o prima di eseguire regolazioni o manutenzioni.**
- Non tirare mai il cavo di alimentazione, o l'apparecchio stesso, per staccare la spina dalla presa di corrente.
- Non lasciare mai incustodito l'apparecchio acceso e non permettere che venga usato come un giocattolo.
- Sorvegliare in continuazione se l'apparecchio è adoperato da bambini o vicino a bambini.
- Mantenere sempre mani, piedi, capelli e indumenti lontani dalle spazzole in movimento.
- Non passare l'apparecchio sul cavo elettrico, per evitare di danneggiare l'isolamento.
- Non aspirare fiammiferi, cenere e mozziconi di sigarette accesi.
- Non aspirare liquidi infiammabili e liquidi in genere.
- Evitare di aspirare oggetti duri o taglienti per non danneggiare il sacco raccogli polvere e l'apparecchio stesso.
- Usare l'apparecchio solo per gli usi per i quali è destinato, come descritto nelle istruzioni.
- Non riaccendere un apparecchio che sembri difettoso.
- Usare e conservare l'apparecchio all'interno di ambienti asciutti e ad una temperatura da +5°C + +35°C (+41°F + +95°F)
- Non esporre l'apparecchio ai raggi solari e UV

WENN MAN ELEKTRISCHE GERÄTE BENÜTZT SOLLTE MAN GEWISSE VORSICHTMASSNAHMEN BEACHTEN, EINSCHLIEßLICH DER FOLGENDEN

ZUR BESONDEREN BEACHTUNG

Lesen Sie die ganze Gebrauchsanweisung vor dem Gebrauch durch

- Die Maschine nicht auf nassen Oberflächen benützen
- **Den Stecker immer aus der Steckdose ziehen wenn das Gerät nicht in Funktion ist sowie vor jeder Wartungsarbeit .**
- Um die Gefahr eines elektrischen Schlages zu vermeiden, darf das Gerät keiner Feuchtigkeit ausgesetzt werden.
- Dieses Gerät ist kein Spielzeug! Es darf nicht in die Hände von Kinder gelangen. Bitte große Aufmerksamkeit bei der Arbeit in der Nähe von Kindern.
- Gebrauchsanweisung und Warnungen des Herstellers beachten. Nur zugelassenes Zubehör verwenden.
- Gerät nie bei beschädigtem Netzkabel benutzen. Gerät zum Service Center bringen wenn es nicht richtig funktioniert, heruntergefallen ist oder dem Regen ausgesetzt wurde.
- Gerät nie am Kabel tragen oder ziehen. Das Kabel sollte nicht in Türen eingeklemmt oder über scharfkantige Gegenstände gezogen werden. Gerät nie über das Kabel rollen. Kabel weit von heißen Oberflächen fernhalten.
- Das Kabel stets am Stecker und niemals am Kabel selbst aus der Steckdose ziehen.
- Haare, Kleider, Finger weit von den Öffnungen und sich bewegenden Teilen des Gerätes fernhalten.
- Zigaretten, Zündhölzer, heisse Asche und andere rauchenden oder brennenden Gegenstände nicht aufsaugen.
- Vor dem Ausziehen des Kabels alle Bedienelemente ausschalten.
- Das Aufsaugen von scharfkantigen oder harten Gegenständen vermeiden.
- Gerät an einem trockenen Ort benützen und aufbewahren. Temperatur zwischen +5°C + +35°C (+41°F + +95°F)
- Gerät nicht Sonnenstrahlen und UV-Strahlen aussetzen

QUAND ON UTILISE DES APPAREILS ELECTRIQUES ON DOIT SUIVRE DES RÈGLES FONDAMENTALES Y COMPRENES LES SUIVANTES

CONSIGNES DE SECURITE

Lire attentivement le mode d'emploi

- Ne pas utiliser la machine sur les sols mouillés
- **Débrancher toujours la prise après l'utilisation ou avant d'entreprendre tout travail d'entretien.**
- Ne jamais tirer par le câble d'alimentation, ni par l'appareil pour débrancher la prise.
- Surveiller toujours l'appareil s'il est en marche et faire attention qu'il ne soit pas utiliser comme un jouet.
- Surveiller toujours l'appareil au cas où il est utilisé par un enfant et près des enfants.
- Garder toujours loin des brosses en mouvement, mains, pieds, cheveux, vêtements.
- Ne pas passer l'appareil par dessus le câble électrique, pour éviter d'abîmer l'isolement.
- Ne pas aspirer les allumettes, les cendres et mégots allumés.
- Ne pas aspirer de liquides inflammables et tout liquide en général.
- Eviter d'aspirer tout objet dur ou tranchant pour ne pas abîmer le sac à poussière ou l'appareil.
- L'utilisation de l'appareil doit être celle indiquée dans le mode d'emploi.
- Ne jamais remettre en marche un appareil qui semble défectueux.
- Utiliser et garder l'appareil dans un endroit sec et à une température de +5°C + +35°C (+41°F + +95°F)
- Ne pas exposer l'appareil aux rayons solaires e UV

CUANDO SE USAN APARATOS ELÉCTRICOS DEBEN TOMARSE NORMALES PRECAUCIONES INCLUIDAS LAS SIGUIENTES" INSTRUCCIONES DE SEGURIDAD

INSTRUCCIONES DE SEGURIDAD

Lea atentamente el manual de instrucciones

- No usar la máquina sobre superficies mojadas.
- **Desconecte siempre el enchufe cuando no use la máquina y antes de hacer una reparación cualquiera.**
- Nunca tire por medio del cable de alimentación o de la máquina para desenchufar.
- No descuide la máquina y no permita que se use como un juguete.
- Siempre hay que vigilar a la máquina si la usan los niños o cerca de niños.
- Mantener siempre las manos, pies, pelo y ropa lejos de los cepillos en movimiento.
- No aspire sobre el cable eléctrico, puede causar daños al aislamiento del hilo.
- No aspire cerillas, ceniza ó cigarrillos que estén todavía encendidos.
- No aspire materiales, líquido inflamable o ningún otro material líquido.
- No aspire materiales cortantes para no estropear la bolsa que recoge el polvo u la máquina.
- Use la máquina para lo que se le indica y como se le describe en las instrucciones.
- No encienda de nuevo la máquina si está defectuosa
- Use y guarde el aparato en lugares secos y con temperatura entre +5°C + +35°C (+41°F + +95°F)
- No esponga el aparato a los rayos solares y UV.

FOR U.S.A. and CANADA COMMERCIAL MARKET ONLY

Connect to a properly grounded outlet only. See grounding instructions.

GROUNDING INSTRUCTIONS IN COMMERCIAL SITUATIONS

WARNING

This machine must be properly grounded to protect the operator from electrical shock, in a commercial environment, in accordance with safety regulations. Read the safety instructions below before operating the machine.

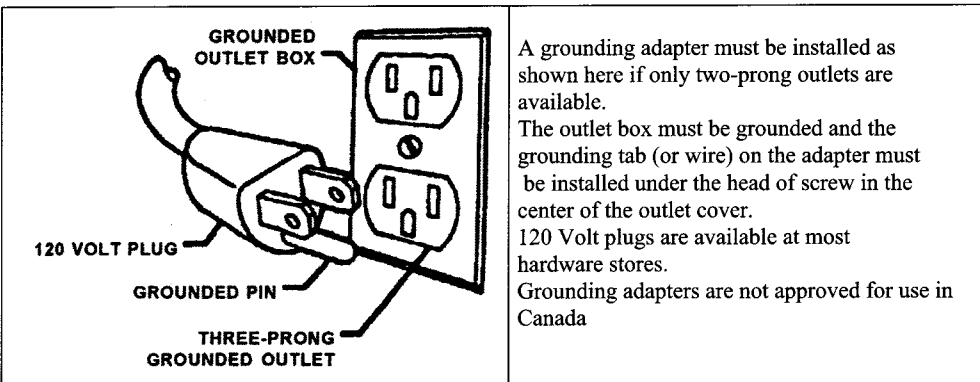
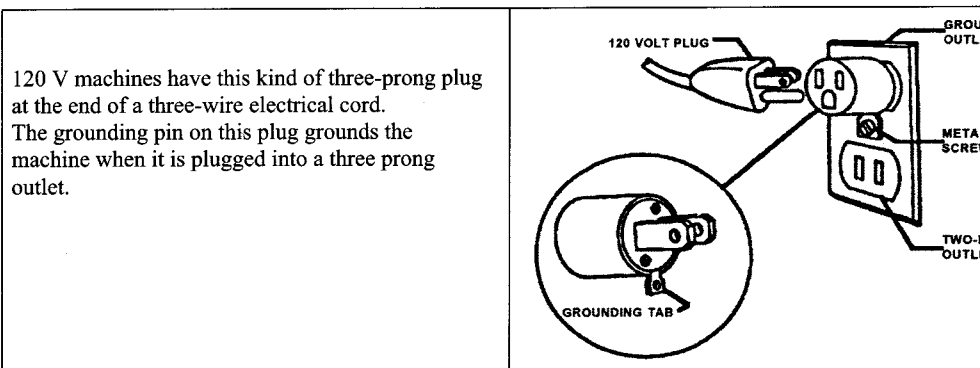

- Replace the plug if the grounding pin is damaged or broken.
- The green or (green/yellow) wire in the cord is the grounding wire.
- When replacing a plug, this wire must be attached to the grounding pin only.
- Extension cords connected to this machine should be 12 gauge, three-wire cords with three-prong plugs and outlets. Do not use extension cord more than 50 feet (15 m.) long.

IMPORTANT

Thermal vacuum motor protector.

The vacuum motor is equipped with a safety thermal protector. Should the vacuum become overloaded by vacuuming with the bag full, or vacuuming with very dirty filters, or if the vacuum should have a clog, the thermal protector will protect the motor from overheating by shutting the motor down automatically. In this case, switch off the vacuum, disconnect the plug and check the bag, check the filters and also check for signs of clogging (see page 9). After the problem is corrected you may resume vacuuming after the thermal protector resets itself (approximately 30-40 minutes).

IMPORTANT

Protettore termo/amperometrico del motore aspirante

Il motore aspirante è provvisto di un termico di sicurezza. In caso di: sovraccarico (aspirare tappeti a pelo alto con regolazione troppo bassa), lavorare con sacco pieno, lavorare con microfiltro/Hepa filtro eccessivamente sporchi, il protettore termico può intervenire per proteggere il motore da eccessivo surriscaldamento. Spegnere la macchina, staccare la spina e controllare: il sacco, il microfiltro/ Hepa filtro ed eventuali ostruzioni (pag. 9). Dopo 30-40 min. circa si può riaccendere la macchina.

WICHTIG

Thermo/Amperemeterschutz des Saugmotors

Der Saugmotor ist mit einem Sicherheitstemperaturbegrenzer ausgestattet. Bei: Überlastung, (Saugen von Teppichen mit hohem Floor mit der niedrigsten Einstellung), Saugen mit vollem Beutel, mit sehr schmutzigem Mikrofilter oder Hepa Filter greift der Schutz ein um eine Überheizung des Motors zu vermeiden. Schalten Sie die Maschine ab, ziehen Sie den Netzstecker aus der Steckerdose und kontrollieren Sie den Papierbeutel, den Mikrofilter/Hepa Filter und eventuelle Verstopfungen (auf Seite 9). Nach 30-40 Min. können Sie die Maschine wieder benutzen.

IMPORTANT

Protecteur thermo/ampèremétrique pour le moteur aspirant.

Le moteur aspirant est pourvu d'un système thermique de sécurité. En cas de: surcharge (aspirer les tapis à poil haut avec une régulation trop basse), aspirer quand le sac est plein, aspirer avec le microfiltre/Hepa filtre trop sales, le thermo-protecteur intervient pour protéger le moteur d'une excessive surchauffe. Débrancher la machine et débrancher la prise de courant et contrôler: le sac à poussière, le microfiltre/le filtre Hepa et les obstructions éventuelles. (page 9). Après 30-40 min. on peut réutiliser la machine.

IMPORTANTE

Protector termo/amperimétrico del motor aspirador

El motor aspirador tiene un protector térmico de seguridad. En caso de sobrecarga (aspirar alfombras de pelo alto con regulación demasiado baja), trabajar con bolsa llena, trabajar con microfiltro/Hepa filtro excesivamente sucios, el protector térmico puede intervenir para proteger el motor de excesivo sobrecalentamiento.

Apagar la máquina, desenchufar y controlar: la bolsa, el microfiltro/ Hepa filtro y eventuales obstrucciones (pág.9). Después de 30-40 min. se puede volver a encender la máquina.

Technical improvements

Advance reserves the right to make technical improvements and modifications without prior notice. For this reason, the appliance can deviate in details from the leaflet information.

Migliorie tecniche

Advance si riserva il diritto di apportare delle migliorie tecniche e delle modifiche senza preavviso. In tal caso alcuni dettagli potranno non risultare conformi alle informazioni riportate sulla documentazione tecnica.

Technische Verbesserungen

Advance behält sich technische Verbesserungen im Rahmen der Modellpflege vor.

Daher kann das Gerät in Details von Prospektangaben abweichen.





Perfectionnements techniques

Advance se réserve le droit de procéder à des perfectionnements techniques dans le cadre de la gestion de ses modèles. Certains détails de la machine peuvent ainsi différer des données indiquées dans les prospectus

Mejoras técnicas

Advance se reserva el derecho a hacer cualquier modificación y arreglo técnico sin previo aviso. Por esta razón, los detalles acerca de la máquina podrían resultar diferentes de las informaciones indicadas en el manual de información.

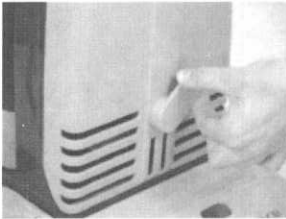
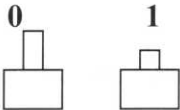
	KNOW YOUR MACHINE	CONOSCI LA TUA MACCHINA	LERNEN SIE IHRE MASCHINE KENNEN	POUR CONNAITRE VOTRE MACHINE	CONOZCA SU MÁQUINA
	Handle grip	Impugnatura	Handgriff mit Gummipfropfen	Poignée	Empuñadura
	Cord strain relief	Gancio passacavo	Kabelhaken	Crochet porte-câble	Gancho pasacable
	Telescopic handle	Impugnatura telescopica	Teleskopischer Griff	Poignée télescopique	Empuñadura telescópica
	4 to 1 stretch hose	Tubo estensibile 4 a 1	Verlängerungsschlauch 4 zu 1	Tube extensible 4 à 1	Tubo extensible 4 a 1
	Telescopic wand	Tubo telescopico	Teleskopisches Rohr	Tube télescopique	Tubo telescópico
	Paper bag storage	Vano porta sacco di ricambio	Raum für Ersatzpapierbeutel	Bac porte-sac de rechange	Vano para la bolsa de recambio
	Carrying handle	Impugnatura di trasporto	Traggriff	Poignée de transport	Manija de transporte
	Crevice tool	Lancia	Flachdüse	Lance	Lanza
	Upholstery tool	Bocchetta	Polsterdüse	Suceur	Boquilla
	Foot pedal	Pedalino	Pedal	Pédale	Pedal
	Non marking rubber wheels	Ruote gommate	Gummiräder	Roues caoutchoutées	Ruedas gomadas
	Upper cord hook	Gancio avvolgicavo superiore	Oberer Kabelhaken	Crochet enrouleur de câble supérieur	Gancho sujeta cable superior
	Power switch	Interruttore di accensione	Hauptschalter	Interrupteur principal	Interruptor de encender
	Full bag light	Spia sacco pieno	Staubbeutelfüllanzeige	Voyant sac plein	Indicador de bolsa llena
	Brush adjusting knob	Manopola di regolazione	Einstellknopf	Poignée de réglage	Manopla de regulación
Lower cord hook	Gancio avvolgicavo inferiore	Unterer Kabelhaken	Crochet enrouleur de câble inférieur	Gancho sujeta cable inferior	
Side cover for easy brush change	Sportello laterale per rapida sostituzione rullo	Seitenabdeckung für einen einfachen Austausch der Bürste	Couvercle latéral pour le changement rapide du rouleau	Tapa lateral para la sustitución rápida del rodillo	
Side wheels	Ruotine laterali	Seitliche Räder	Roues latérales	Ruedas laterales	

    	<p>ASSEMBLY INSTRUCTIONS</p> <p>Insert the chrome handle into the hole in the top of the switch housing. Push down until the button snaps into the proper position</p> <p>Wind the electrical cord around the cord hook on the handle and the swing out cord hook on the back of the machine.</p> <p>To release the cord, rotate the lower cord hook and remove the cord.</p> <p>OPERATING INSTRUCTIONS</p> <p>Switch on the machine by pushing the green power switch,</p> <p>0 is OFF 1 is ON</p> <p>depress the foot pedal (by foot) and move the vacuum body into working position.</p>	<p>ISTRUZIONI PER LA MESSA IN FUNZIONE</p> <p>Inserire il tubo cromato nell'apposita sede e premere fino a quando il pulsante scatta nell'apposita sede.</p> <p>Avvolgere il cavo tra i ganci avvolgicavo superiore e inferiore situati nel retro della macchina.</p> <p>Per sganciare il cavo dagli appositi agganci, ruotate il gancio avvolgicavo inferiore.</p> <p>ISTRUZIONI PER IL FUNZIONAMENTO</p> <p>Accendere la macchina schiacciando l'interruttore di accensione,</p> <p>0 è SPENTO 1 è ACCESO</p> <p>premere il pedolino di sgancio ed inclinare la macchina in posizione di lavoro.</p>	<p>MONTAGE</p> <p>Führungsstange in die Öffnung des Saugaggregats einsetzen und hinunterdrücken bis der Aretierknopf einschnappt.</p> <p>Das Kabel zwischen dem oberen und dem unteren Kabelhaken, die sich auf der Rückseite der Maschine befinden, aufrollen.</p> <p>Das aufgewickelte Netzkabel kann schnell vom Haken gelöst werden, indem der untere Kabelhaken gedreht wird.</p> <p>BEDIENUNG DER MASCHINE</p> <p>Klippschalter einschalten</p> <p>0 ist AUS 1 ist EIN</p> <p>und die Führungsstange durch Drücken des Fusspedals entrasten und in Arbeitsposition bringen.</p>	<p>MONTAGE</p> <p>Introduire le tube chromé dans son logement et appuyer jusqu'à ce que le bouton se bloque.</p> <p>Enrouler le câble d'alimentation aux crochets supérieurs et inférieurs qui se trouvent derrière la machine.</p> <p>Pour décrocher le câble des crochets, il suffit de tourner le crochet enrouleur de câble inférieur.</p> <p>MISE EN SERVICE DE LA MACHINE</p> <p>Allumer l'aspirateur appuyant sur l'interrupteur principal</p> <p>0 est ÉTEINT 1 est ALLUMÉ</p> <p>Appuyer sur la pédale et incliner la machine en position de travail.</p>	<p>INSTRUCCIONES PARA EL MONTAJE</p> <p>Introduzca el tubo cromado dentro del hueco y empuje hacia abajo hasta que el botón se encaje en el hueco.</p> <p>Enrolle el cable alrededor del gancho superior e inferior situados detrás de la máquina.</p> <p>Para soltar el cable de los ganchos, hay que girar el gancho pasacable inferior.</p> <p>INSTRUCCIONES PARA EL FUNCIONAMIENTO</p> <p>Encender la máquina apretando el interruptor</p> <p>0 está APAGADO 1 está ENCENDIDO</p> <p>apretar el pedal e inclinar la máquina en posición de trabajo.</p>
--	--	---	--	---	--



BRUSH HEIGHT ADJUSTMENT

Your carpet cleaner has 4 wheels, two rear wheels and two adjustable front wheels.

Based on your carpet pile, use the adjusting knob (see photo), to lift or lower the base.



Low Pile



Deep Pile

In case of area rugs with fringed ends the machine must be used from the center to the outside. For the best result on wall to wall carpet follow the natural weave of the carpet to obtain a consistent surface appearance.

If the brush roll should stop (due to running over something large, such as a sock, or rug fringes) the electronic overload control will switch off the motor leaving the red light on.

In this case shut off the vacuum, unplug the machine, inspect the brush roll and remove any debris using the wand.

On board attachments are provided for above the floor vacuuming requirements. Lift the wand first "1" then pull it out past the wand clip on the right "2". Slide accessory onto the end of the wand.

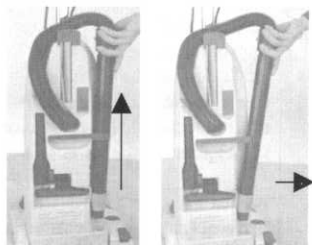
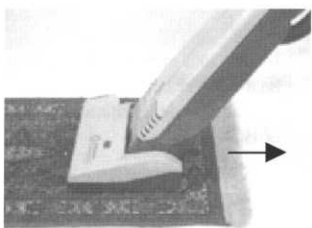

1

2



DISPOSITIVO PER REGOLARE L'ALTEZZA

Il Vs battitappeto è provvisto di 4 ruote, due posteriori e due anteriori regolabili in altezza.

In base all'altezza del pelo del Vs. tappeto o moquette, per mezzo della manopola di regolazione indicata in figura, alzate o abbassate la base.



Pelo Basso



Pelo Alto

In caso di tappeti con frange bisogna procedere dall'interno verso l'esterno. Con tappeti a tinta unita o moquette con trame che tendono a formare strisce, è consigliabile seguire la direzione del pelo per ottenere una superficie omogenea.

In caso di bloccaggio del rullo (passando sopra qualcosa di grande tipo stracci o frange), interviene il controllo elettronico del sovraccarico che spegne automaticamente il motore lasciando la spia rossa accesa.

Spegnerne immediatamente l'apparecchio, staccare la spina dalla presa di corrente e poi controllare la zona rullo ed eliminare la causa del bloccaggio.

Il vostro battitappeto è anche un aspirapolvere per la pulizia aerea ed è dotato di utili accessori. Estrarre il tubo "1" e poi sganciarlo di lato "2".

SAUGBÜRSTEN HÖHENVERSTELLUNG

Ihre Teppichklopmaschine ist mit 4 Räder ausgestattet (2 hinten und 2 vorne) die in der Höhe regulierbar sind. Gemäß der Haarhöhe Ihres Teppichs oder Teppichbodens heben oder senken Sie den Bürstfuß mit dem im Bild gezeigten Griff.



Niedriges Ha



Hohes Haar

Teppiche mit Fransen sollten von innen nach aussen gesaugt werden. Unifarbige oder tieffloorige Teppiche solten immer in Richtung des Floors (im Strich) gesaugt werden.

Falls die Bürstenwalze blockiert (weil Sie über etwas Grosses wie einen Socken oder ein Tuch gefahren sind) schaltet die elektronische Überlastungskontrolle ein, welche den Motor automatisch abstellt während die rote Kontrolllampe anbleibt.

Maschine abstellen und Stecker herausziehen, danach Bürstenwalze kontrollieren und säubern falls erforderlich.

Ihre Teppichklopmaschine ist auch ein Staubsauger für die allgemeine Reinigung und ist mit nützlichem Zubehör ausgestattet. Das Rohr leicht heben „1“ und dann seitlich herausziehen „2“.

DISPOSITIF RÉGLAGE DE LA HAUTEUR

Votre aspiro-batteur est pourvu de 4 roues, 2 postérieures et 2 antérieures, elles peuvent être réglées en hauteur. Selon la hauteur du poil des vos tapis ou moquettes, lever ou baisser la poignée de réglage indiquée dans le schéma.

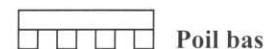

Poil bas



Poil haut

Sur les tapis à franges, il faut passer l'aspirateur de l'intérieur vers l'extérieur. Sur les tapis à teinte unie ou à trames qui on la tendance à laisser des rayures, il est conseillé de suivre le sens du poil afin d'obtenir une surface homogène.

En cas de blocage du rouleau, (si l'on passe sur quelque chose de grand comme un chiffon ou sur des franges), le contrôle électronique de surcharge intervient en éteignant automatiquement le moteur et laissant le voyant rouge allumé.

Eteindre immédiatement l'appareil, débrancher la prise de courant et contrôler la zone du rouleau et éliminer la cause du blocage.

Votre aspiro-batteur est aussi un aspirateur pour le nettoyage des hauteurs et est équipé de plusieurs accessoires utiles. Extraire le tube « 1 » et ensuite le décrocher du côté « 2 ».

DISPOSITIVO DE REGULACIÓN DE LA ALTURA

Su aspiradora tiene 4 ruedas, dos posteriores y dos anteriores, cuya altura se puede regular. Según la altura del pelo de su alfombra levante o baje la base por medio de la manopla de regulación indicada en la figura.



Pelo bajo



Pelo alto

Con alfombras con franjas se proceda del interno hacia el externo. Con una alfombra lisa ó cuyos tejidos tienen una tendencia a formar líneas, es aconsejable seguir la dirección del material para conseguir un aspecto consistente en la superficie.

En caso de bloqueo del rodillo (si pasen sobre algo grande como los trapos o franjas) interviene el control electrónico que apaga automáticamente el motor dejando encendida la luz roja.

Apague en seguida la máquina, desenchufe y luego controle la zona rodillo y elimine la causa del bloqueo.

Su aspiradora batidora puede transformarse también en aspiradora para la limpieza de las alturas con los accesorios útiles disponibles. Extraer el tubo "1" y sacarlo del lado "2".



CAUTION!
ALWAYS DISCONNECT THE
POWER CORD BEFORE
PERFORMING ANY
MACHINE MAINTENANCE.

**CHANGING THE PAPER
FILTER BAG**

Gently lift the latch on the front of the bag housing cover and remove it. Remove the full dust bag by carefully removing the cardboard from the safety latch and slide the bag towards you. Seal the used paper bag using the cardboard tab to cover the opening.

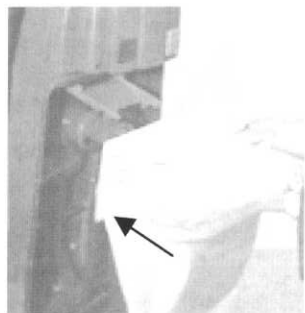

Install a new paper bag by sliding the opening over the tube and with your fingers, press the vertical cardboard until it touches the ribs of the bag housing.



Hook the top cardboard to the red safety latch (directions for installing a new bag are also printed on the bags themselves). Replace the paper bag when the red full bag light is on, or if you notice the performance of the machine decline.

Never operate the machine without an original Advance paper bag.



VACUUM INLET FILTER
This filter protects the vacuum motor from damage due to spilled paper bags. It provides for the 3rd stage of filtration. **Clean the filter every third time that the paper bag is changed.** Remove filter from grill and wash out in warm water. **Let the filter dry "completely" before putting back into the machine.** Never operate the machine without the inlet filter.

ATTENZIONE!
STACCARE SEMPRE LA SPINA
DALLA PRESA DI CORRENTE
PRIMA DI ESEGUIRE
QUALSIASI MANUTENZIONE.

**SOSTITUZIONE DEL SACCO
FILTRO**

Aprire lo sportello tirando leggermente il gancio sportello. Sfilare il sacco di carta seguendo all'inverso le istruzioni di montaggio stampate sui nuovi sacchi filtro. Sigillare il sacco per mezzo del cartoncino di chiusura.

Inserire il nuovo sacco nel tubo fino a che il cartoncino verticale tocchi le nervature del contenitore sacco.

Agganciare poi il cartoncino superiore all'apposito gancio reggi sacco di sicurezza rosso (istruzioni sono anche stampate sui sacchi filtro). Il sacco si sostituisce ogni qual volta si accende la spia rossa o se notate una riduzione delle prestazioni della Vs. macchina.

Non usare mai l'apparecchio senza un sacco filtro originale Advance all'interno.

FILTRO PROTEZIONE MOTORE
Questo filtro protegge il motore da eventuali danni provocati da fuoriuscite del sacco e consente il 3^o stadio di filtraggio. **Pulire il filtro ogni 3^o cambio del sacco.** Togliere il filtro dalla griglia e lavarlo con acqua tiepida. **Lasciare asciugare completamente il filtro prima di inserirlo nuovamente nella macchina.** Non utilizzare la macchina senza il filtro protezione motore.

ACHTUNG!
DEN NETZKABEL IMMER AUS
DER STECKDOSE ZIEHEN,
WENN DIE MASCHINE
WEGGERÄUMT ODER
GEWARTET WIRD.

DEN FILTERBEUTEL ERSETZEN

Den Deckel öffnet man durch leichtes Drücken der Taste an der oberen Kante. Den vollen Staubsack am verstärkten Ende oben anfassen, nach unten ziehen, entfernen und gut verschliessen.

Den neuen Staubsack im Rohr einsetzen und den oberen Karton mit den Fingern bis zur Rückwand schieben.

Danach wird der obere Karton im roten Beutelhalter eingeklemmt (die Installationsanweisungen sind auch auf den Filterbeutel angegeben) Den Staubsack jedesmal ersetzten, sobald die rote Lampe aufleuchtet oder wenn die Leistung der Maschine nachlässt.

Gerät nie ohne einen originalen Advance Staubbeutel benutzen.

INNERER FILTER
Dieser Filter schützt den Motor vor eventuellen Staubpartikeln aus dem Staubbeutel und stellt die 3. Filtrierungsstufe dar. **Nach jedem dritten Staubbeutelwechsel sollte der Luftfilter gereinigt werden.** Luftfilter mit Halterung herausziehen, Schaumstoffeinsatz mit lauwarmem Wasser auswaschen, vollkommen trocken lassen und wiedereinssetzen. **Die Maschine nie ohne Filter benutzen.**

ATTENTION!
DÉBRANCHER TOUJOURS LA
PRISE DE COURANT AVANT
D'EFFECTUER TOUTE SORTE
D'ENTRETIEN

**CHANGEMENT DU SAC
FILTRE**

Ouvrir le couvercle en tirant légèrement le crochet. Ôter le sac en papier en suivant au contraire les instructions de montage indiquées sur les nouveaux sacs filtre. Refermer le sac à l'aide du carton de fermeture.

Remettre un nouveau sac dans le tube jusqu'à ce que le carton vertical touche les nervures du bac contenant le sac.

Accrocher le carton supérieur au crochet rouge qui soutient le sac de sûreté (les instructions sont indiquées aussi sur les sacs filtre). Le sac doit être remplacé chaque fois que le voyant rouge s'allume ou si vous remarquez une réduction de performance de votre machine.

Ne jamais utiliser la machine sans un sac filtre original Advance à l'intérieur.

FILTRE PROTECTION DU MOTEUR
Ce filtre protège le moteur contre les dégâts provoqués par toute fuite du sac et permet le 3^o stade de filtrage. **Nettoyer le filtre au 3^o changement du sac.** Enlever le filtre de la grille et le laver à l'eau tiède. **Le laisser sécher complètement avant de le replacer dans la machine.** N'utiliser jamais la machine sans le filtre protégeant le moteur.

¡ATENCIÓN!
DESCONECTE SIEMPRE EL
CABLE ANTES DE LLEVAR A
CABO CUALQUIER
MANTENIMIENTO.

**SUSTITUCIÓN DE LA BOLSA
FILTRO**

Abrir la tapa tirando ligeramente por medio del gancho. Quite la bolsa de papel siguiendo al contrario las instrucciones imprimidas sobre las nuevas bolsas filtro. Cerrar la bolsa por medio del cartón de cerradura.

Inserte una nueva bolsa en el tubo hasta que el cartón toque las nervaduras del contenedor de la bolsa.

Luego enganchar el cartón superior al gancho rojo que sirve para la bolsa de seguridad (las instrucciones están imprimidas sobre las bolsas filtro). Hay que substituir la bolsa cada vez que se enciende la luz roja y si notan una reducción de las prestaciones de su máquina.

Nunca use la máquina sin la bolsa filtro original de Advance en el interno

FILTRO PROTECCIÓN MOTOR
Este filtro protege el motor de los daños casuales que pudieran provocar salidas desde la bolsa de papel, y permite la 3^a fase de filtración. **Cada 3 cambios de bolsa se debe limpiar este filtro.** Quitar el filtro de la rejilla y limpiarlo en agua templada. **Secar el filtro completamente antes de ponerlo de nuevo en la máquina.** Nunca use la máquina sin este filtro de protección del motor.



CHANGING THE EXHAUST FILTER

The electrostatic exhaust filter catches any particles that may escape from the filter bag, vacuum inlet filter, or lower motor filter. The electrostatic exhaust filter is located just below the inlet filter. Replace the filter every fourth time you change the bag (more often in very dusty environments). To replace the electrostatic filter follow these directions (this is most easily accomplished with the vacuum standing upright at your eye level): Release the grill and replace the exhaust filter with a new original Advance filter (when you put the grill into place, with one hand hold the filter while the other insert the grill). Lie filter and grill flat and snap the red latch of the vacuum to the gray tab of the exhaust grill.



Never operate the vacuum without the original Advance Exhaust Filter in place.

HEPA FILTER

The Hepa filter is available as an option. This special filter assures 99.97% filtration efficiency at 0.3 micron for the ultimate in air filtration in the most critical applications. Change the Hepa filter every 8 bags or more often if it's used in a very dusty environment. If the paper bag should break, the Hepa filter must also be replaced.

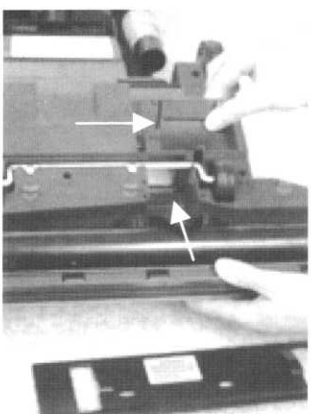

CLOGGING

In case of clog (which could be the problem if your bag full light is on yet your bag is not full) check the following locations: remove the bag and check the internal tube, look through the stretch hose, check the telescopic wand and throat tube that holds the wand, look over the whole brush roll area. Remove any debris that may be obstructing these areas and causing the clog.

SOSTITUZIONE MICROFILTRO USCITA ARIA

Il filtro elettrostatico blocca le microparticelle che gli altri filtri non riescono a trattenere ed evita la fuoriuscita di micropolvere di carbone prodotta dal motore. Il microfiltro è situato nella zona sotto il filtro protezione motore. Sostituire il microfiltro ogni 4^a sostituzione del sacco di carta (più spesso in applicazioni molto polverose). Per sostituire il microfiltro, seguite le seguenti istruzioni (questo risulta più facile se mettete il battitappeto all'altezza dei Vs. occhi):

1. Sganciare la griglia e sostituire il microfiltro con uno nuovo originale Advance facendo attenzione ad applicarlo nella corretta posizione. (quando si rimonta la griglia, con l'altra mano trattenere il microfiltro in posizione). Appoggiare il microfiltro e la griglia al piano ed agganciare la griglia all'apposito gancio rosso di sicurezza. **Attenzione. Non usare mai la macchina senza il microfiltro elettrostatico originale Advance.**

FILTRO HEPA

Il filtro Hepa è disponibile come opzionale. Questo speciale filtro assicura un'efficienza filtrante del 99,97% a 0,3 micron ed è adatto alle più critiche applicazioni. Sostituire il filtro Hepa massimo ogni 8 sacchi filtro, più spesso se si usa l'apparecchio in ambienti molto polverosi. In caso di rottura del sacco filtro, anche il filtro hepa deve essere sostituito.

OSTRUZIONI

In caso di ostruzioni, è semplice controllare l'intero circuito di aspirazione: togliere il sacco e controllare che il tubo interno sia libero, poi il tubo flex, il tubo rigido e la base dalla zona rullo al tubo convogliatore. Rimuovere qualsiasi detrito che ha causato l'ostruzione e riassemblare correttamente.

AUSTAUSCHEN DES ELEKTROSTATISCHEN AUSLABFILTERS

Zweck dieses Filters ist es, Staub, der durch die anderen Filtrierungsstufen gelangt, aufzufangen. Der Filter befindet sich direkt unter dem Schutzfilter des Motors und sollte nach jedem vierten Wechsel des Staubbeutel ersetzt werden, häufiger bei sehr staubigen Reinigungsanwendungen. Um den Filter zu ersetzen, beachten Sie die folgenden Anweisungen (dies erscheint viel einfacher, wenn sich der Bürstsauger auf Ihrer Augenhöhe befindet):

1. Filterdeckelklinge drücken und Auslaßfilterdeckel entfernen. Filter aus der Halterung herausnehmen und mit einem neuen Advance Filter ersetzen. Filterdeckel zurückstellen. (Bei der Zurückstellung des Filterdeckels, halten Sie den Filter mit einer Hand). Das Gitter und den Mikrofilter auf die Fläche legen und am roten Sicherheitshaken einhängen.

Achtung: Gerät nie ohne einen originalen elektrostatischen Advance Filter benutzen.

HEPA FILTER

Der Hepa Filter ist als optional erhältlich. Dieser spezielle Filter hat eine Filtrierleistungsfähigkeit von 99,97 % zu 0,3 Mikron und ist für die kritischsten Anwendungen geeignet. Sollte der Papierfilterbeutel reißen, muß auch der Hepa-Filter gewechselt werden. Der Hepa-Filter sollte immer nach 8 Papierfilterbeuteln erneuert werden, häufiger wenn in sehr staubigen Räumen gesaugt wird.

VERSTOPFUNG

Falls Ihre Maschine verstopft sein sollte, ist es einfach die ganze Saugschaltung zu kontrollieren: Nehmen Sie den Papierbeutel ab und kontrollieren Sie ob das innere Rohr, der Saugschlauch, das teleskopische Verlängerungsrohr und die Bürstenwalze verstopft sind. Die Verstopfungsursache beheben und alle Teile wieder zusammensetzen.

REPLACEMENT DU FILTRE ELECTROSTATIQUE

Ce filtre retient les particules fines qui s'échappent des autres filtres ainsi que les poussières de charbon produites par le moteur. Le microfiltre est situé dans la zone sous le filtre protection du moteur. Remplacer ce filtre tous les 4 changements de sac en papier, (plus souvent dans des conditions de nettoyage particulièrement poussiéreuses). Pour changer le microfiltre, suivre les instructions (cela apparaît plus facile si vous mettez votre aspirateur à la hauteur de vos yeux).

1. Enlever la grille et remplacer le microfiltre avec un filtre nouveau et original Advance en faisant attention à le remettre dans la juste position. (quand on remonte la grille, tenir de l'autre main le microfiltre). Poser le microfiltre et la grille à sa place et accrocher la grille grâce au crochet de sécurité.

Attention. Ne jamais utiliser la machine sans que le filtre électrostatique original Advance soit en place.

HEPA FILTER

Le filtre Hepa est disponible en option. Ce filtre spécial assure une efficacité filtrante de 99,97% à 0,3 microns et est adapté aux applications les plus critiques. Remplacer le filtre Hepa au maximum tous les 8 sacs filtre, plus souvent si l'appareil est utilisé dans des endroits avec beaucoup de poussière. En cas de rupture du sac filtre, le filtre Hepa doit aussi être remplacé.

OBSTRUCTIONS

En cas d'obstruction de la machine, il est simple de contrôler tout le circuit d'aspiration: enlever le sac et contrôler que le tube interne soit libre, ensuite le tube flex, le tube rigide et la base de la zone du rouleau au tube extensible. Enlever les débris qui ont causés l'obstruction et rassembler correctement.

SUSTITUCIÓN DEL FILTRO ELECTROSTATICO

El filtro electrostático coge cualquier micropartícula que pueda escapar de otros filtros, también el micropolvo producido por el motor. El microfiltro está situado en la zona debajo del filtro de protección del motor. Sustituir el microfiltro cada 4 bolsas de papel que use (si usa la aspiradora en lugares muy polvorientos debe cambiarse más a menudo). Para sustituir el filtro electrostático (eso parece más fácil si ponen la aspiradora a la altura de sus ojos):

1. Extraiga la rejilla y sustituya el microfiltro con un nuevo filtro Advance en su lugar, teniendo cuidado en montarlo correctamente. (Al montar otra vez la rejilla soportar el microfiltro en posición con la otra mano). Ponga el microfiltro y la rejilla al gancho rojo de seguridad.



¡Atención! Nunca debe de utilizar el aparato sin un filtro electrostático original Advance.

FILTRO HEPA

El filtro Hepa está disponible como opcional. Este filtro especial asegura un filtrado eficiente del 99,97% a 0,3 micrones y se adapta a las aplicaciones más críticas. Hay que sustituir el filtro Hepa como máximo cada 8 bolsas filtro y más en lugares muy polvorientos. En caso de rotura de la bolsa, hay que sustituir también el filtro Hepa.

OBSTRUCCIONES

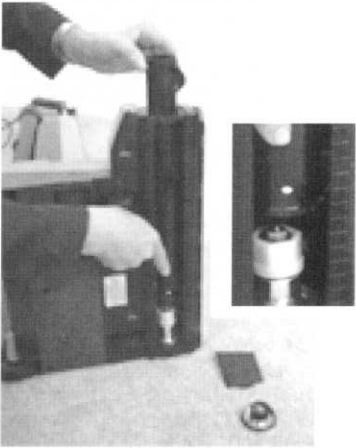
En caso de obstrucciones, es fácil controlar el circuito entero de aspiración: quitar la bolsa y controlar que el tubo interno esté libre, luego el tubo flex, el rígido y la base de la zona rodillo al tubo extensible. Quitar los detritos que causaron la obstrucción y montar de nuevo correctamente.

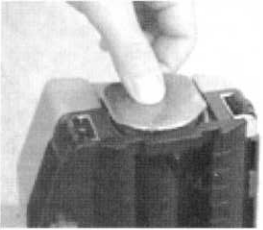
	<p>CHANGING THE BRUSH ROLLER</p>	<p>SOSTITUZIONE DEL RULLO</p>	<p>AUSWECHSELN DER BÜRSTE</p>	<p>CHANGEMENT DE BROSSE</p>	<p>SUSTITUCIÓN DEL RODILLO</p>
   	<ol style="list-style-type: none"> 1. Standing behind the vacuum lay it on the left side. 2. Slide the side cover upwards off the end of the base housing (reuse this piece after inserting the new brush). 3. Grasp the bristles of the brush roll from the bottom of the vacuum pull it up and slide it out the right side of the housing (you will reuse the metal brush support on the new brush roll also). 4. Look inside the brush roll for the end that has a hexagon shape cut out. This is also the end that will have a white dot on the outside of the brush roll. Put this end in first. Line up the white dot with a flat portion of the drive. 5. Make sure the brush roll goes all the way down over the drive. Look to see that none of the brush bristles are caught between the metal support and the brush (the metal support will not fit properly if there are any brush bristles sticking up and out of the end, it will also damage the bristles of your brush roll) 6. Reassemble the metal brush support and then the side cover. 	<ol style="list-style-type: none"> 1. Stendere l'apparecchio sul lato sinistro. 2. Togliere il coperchio laterale dal vano portaspazzola. 3. Estrarre il rullo afferrandolo per le setole assieme al supporto rullo dall'estremità della spazzola (supporto che verrà riutilizzato con la nuova spazzola). 4. Inserire prima l'estremità della spazzola con l'apertura esagonale dell'apposito vano, facendo combaciare una faccia piana del trascinatore esagonale con il punto bianco del rullo, assicurandosi che scorra fino in fondo raggiungendo il supporto di trasmissione. 5. Assicurarsi che il rullo sia posizionato correttamente e che le setole laterali siano all'interno del supporto in metallo (il supporto in metallo non entrerà correttamente se ci sono ancora setole fuoriposto e inoltre danneggerà le setole del vostro rullo). 6. Rimontare il supporto rullo e poi inserire lo sportello laterale. 	<ol style="list-style-type: none"> 1. Legen Sie die Maschine so hin, daß sie auf der linken Seite liegt. 2. Schieben Sie die Seitenabdeckung aus dem Bürstengehäuse. 3. Lösen Sie die Rolle mit der Halterung, indem Sie sie an den Borsten halten, vorsichtig vom Ende der Bürste (Halterung wird bei der neuen Bürste wieder verwendet). 4. Schieben Sie die Bürste mit der sechseckigen Öffnung voran in das Gehäuse. Der Bezugspunkt (Photo) besteht darin, eine flache Seite des Mitnehmers mit dem weißen Punkt der Rolle in Übereinstimmung zu bringen. Vergewissern Sie sich, daß die Bürste bis ganz nach unten an die Getriebshalterung geschoben ist. 5. Sicherstellen, daß die Rolle richtig eingefügt worden ist und die Seitenborsten sich alle auf der Innenseite der Aluminiumhalterung befinden (die Halterung lässt sich nicht gut schliessen falls noch Borsten herauschauen und zudem werden die Borsten der Rolle beschädigt) 6. Bürstenhalterung wieder aufmontieren und Seitenabdeckung zuschieben 	<ol style="list-style-type: none"> 1. Coucher la machine sur le côté gauche. 2. Faire coulisser le couvercle latéral hors du boîtier de la brosse. 3. Extraire délicatement le support du rouleau par l'extrémité de la brosse (le support sera réutiliser avec la nouvelle brosse). 4. Introduire d'abord l'extrémité de la brosse avec l'ouverture hexagonale dans le boîtier, le point référence (photo) consiste à faire coïncider un côté plein du dispositif de traction avec le point blanc de rouleau, en vérifiant qu'elle soit bien enfoncée jusqu'au bout du support de transmission. 5. Faire attention à ce que le rouleau soit bien en place et que les poils latéraux soient à l'intérieur du support en métal. (le support en métal n'entrera pas correctement si les poils ne sont pas bien en place et en outre, il abîmera les poils de votre rouleau). 6. Remplacer le support du rouleau et insérer le couvercle latéral. 	<ol style="list-style-type: none"> 1. Poner la máquina sobre el lado izquierdo. 2. Quitar la porta lateral del hueco del cepillo. 3. Sacar el soporte del rodillo de la extremidad del cepillo (el soporte será reutilizado para el cepillo nuevo). 4. Introducir antes en su lugar la extremidad del cepillo con la abertura hexagonal, haciendo encajar una cara llana del dispositivo de tracción con el punto blanco sobre el cepillo (foto), asegurándose de que se inserte completamente en el soporte de transmisión. 5. Asegúrese de que el rodillo esté bien instalado en su lugar y que las cerdas laterales estén internamente al soporte metálico.(el soporte metálico no entrará correctamente si la cerdas no están bien puestas y además irán a estropear las cerdas del rodillo). 6. Montar el soporte del rodillo y luego insertar la porta lateral.

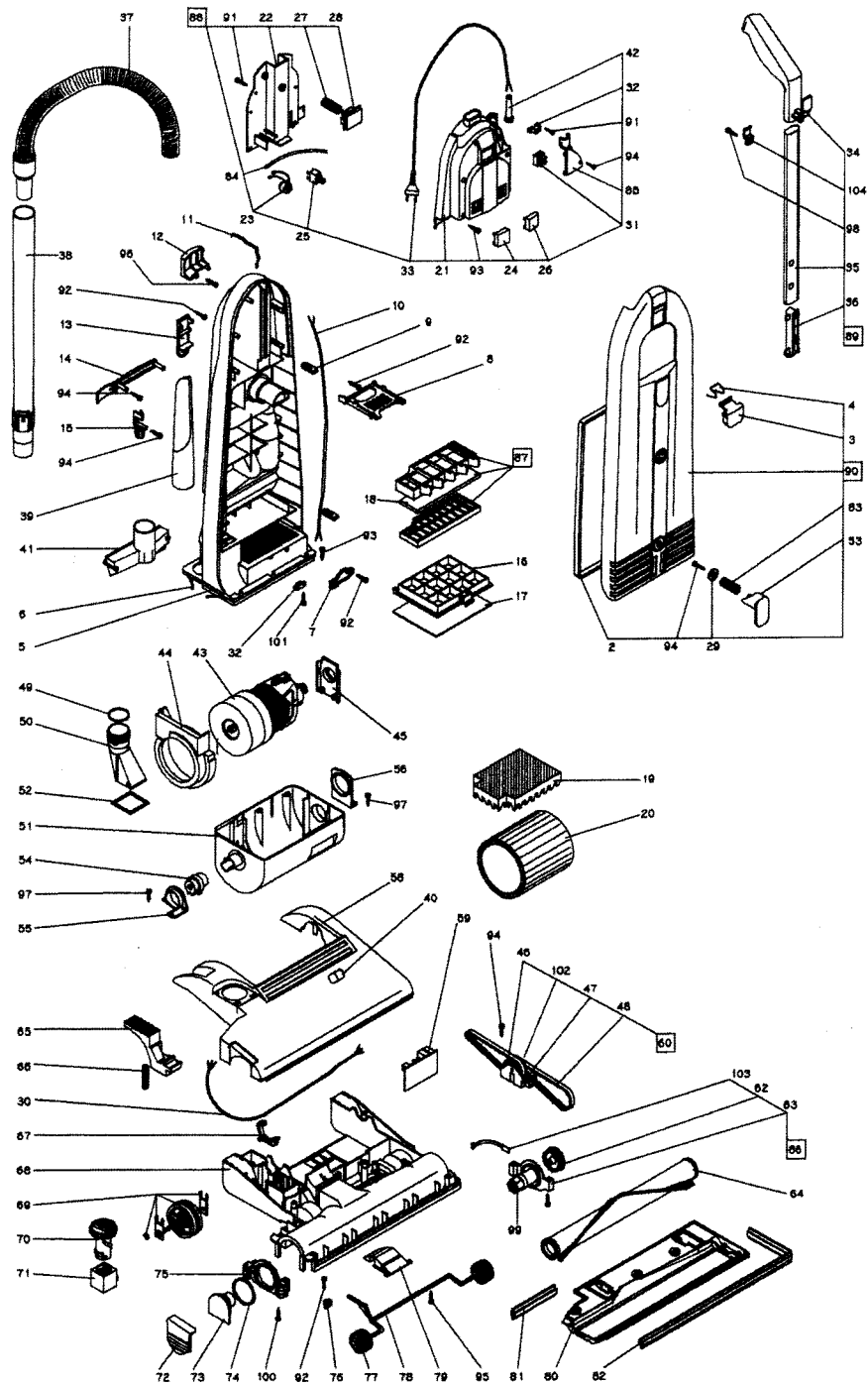

**PowerOne 12 / 15 LIMITED WARRANTY
FOR MODELS 56704300 & 56704301 ONLY**

Nilfisk-Advance Inc. warrants each new PowerOne 12 - 15 carpet vacuum against defects in material and workmanship under normal use and service. The obligation under this warranty is limited to repair or replace at our factory or authorized distributor service station any part or parts thereof which within the warranty period are returned to our factory or authorized distributor service station, transportation prepaid, after examination discloses it to have been thus defective.

The warranty period during which coverage applies to the motor and belt is two (2) years, basic coverage is one (1) year for parts replacement (electrical components is 90 days) and one (1) year for service labor. The start date of the warranty coverage shall be the purchase date by the original end user, or six months from the date the machine was shipped from the factory, whichever is earlier. The Warranty Registration Card is to be completed and returned immediately at the time of purchase.

This warranty shall not apply to: (1) accidents and misuse, (2) damage in transit, (3) overloading the capacity of the machine, (4) failure due to lack of proper maintenance or care as described in the operating and maintenance instructions, (5) relatively minor adjustments such as tightening of screws or bolts, etc., not connected with the replacement of parts, (6) repairs or alterations by an organization other than the factory or an authorized Nilfisk-Advance Service Center. (7) replacement of expendable wear items such as carbon motor brushes when the replacement is not due to a defect in material or workmanship.

STATED WARRANTIES ARE IN LIEU OF ALL OTHER WARRANTIES, EXPRESSED OR IMPLIED. Any statutory implied warranties, including any warranty of merchantability or fitness for a particular purpose, are expressly limited to the duration of this written warranty. Nilfisk-Advance will not be liable for any other damages arising out of or in connection with the furnishing, performance, use of or inability to use the machine. This remedy shall be the exclusive remedy of the Buyer.

Authorized Nilfisk-Advance Centers can assist owners in the proper handling of any warranty question or claim. In the event that you want to contact Nilfisk-Advance directly, please write to the Customer Service Department at Nilfisk-Advance, Inc., 14600 21st Avenue North, Plymouth, Minnesota 55447-3408. Provide an explanation of the problem and include the serial number of the machine as well as the name of the selling organization. The Customer Service Department will investigate and then contact you.

Cut out and mail to:
 Nilfisk-Advance, Inc.
 14600 21st Avenue North
 Plymouth, Minnesota 55447-3408

IMPORTANT: This card contains information necessary to expedite warranty protection.
 Mail within 30 days of purchase to Nilfisk-Advance.

LIMITED WARRANTY
 PLEASE PRINT

Purchaser _____
 Address _____
 City _____ State _____ Zip _____
 Model _____ Serial Number _____
 Purchased from _____
 City _____ State _____ Zip _____
 Date Purchased _____

**THIS IS TO CERTIFY THAT THE ABOVE EQUIPMENT
 WAS CHECKED OUT IN WORKING CONDITION.**



Advance
PowerOne 12 15

SPARE PARTS LIST - LISTA PARTI DI RICAMBIO
LISTE DER ERSATZTEILE - LISTE DE PIECES - LISTA DE PIEZAS

POS	PART NO	DESCRIPTION	POS	PART NO	DESCRIPTION	POS	PART NO	DESCRIPTION
2	56704303	Bag door gasket	41	56703774	Upholstery tool	77	56703757	Front wheel-nylon
3	56704304	Bag door latch	42	56703662	Strain relief	78	56704367	Front axle
4	56704305	Bag door spring	43	56704337	Vacuum motor with pulley R26APSS V. 120/60 W. 750/850	79	56704368	Channel cover
5	56704306	Bag housing				80	56704369	Roller cover 12
6	56704307	Bag housing gasket				80	56704370	Roller cover 15
7	56704308	Exhaust grill latch	44	56704338	Motor gasket	81	56704371	Back bumper 15
8	56704309	Bag safety support	45	56704339	Brush holder gasket	82	56704372	Front bumper 12
9	56704310	Strain relief	46	56704340	Double pulley with bushes	82	56704373	Front bumper 15
10	56704311	Internal cord 3 wires, 120V	47	56704341	Double support	83	56703943	Spring, cable clip
11	56704312	Antistatic spring	48	56704342	Timing belt	84	56704374	Rubber tube
12	56704313	Hose support	49	56704343	O ring	85	56704375	Terminal block cover
13	56704314	Closing cap	50	56704344	Throat tube	86	56704376	Transmission support complete w/sensor
14	56704315	Transport handle	51	56704345	Motor housing dark gray w/electronic shut off	87	56704377	Complete grill
15	56704316	Accessory clip	52	56704346	Throat gasket	88	56704378	Electric panel complete V.120/60
16	56704317	Exhaust grill	53	56704347	Lower cord hook	89	56704379	Handle tube assembly
17	56704318	Exhaust micro filter 5 pcs.	54	56704348	Bush			
18	56704319	Motor protection filter	55	56704349	Right support	90	56704380	Bag door assembly.
19	56704320	Foam filter	56	56704350	Left support	91	56704384	Screw 2,9x19 - 20 pack
20	56703945	Sound reduction foam	58	56704351	Base housing cover 12	92	56704385	Screw 3,5x9.5 tg - 20 pack
21	56704321	Electric panel housing	58	56704352	Base housing cover 15	93	56704386	Screw 3,5x25 - 20 pack
22	56704322	Electric panel cover	59	56704353	Circuit board V. 100/120			
23	56704323	Vacuum sensor with light	60	56704354	Central transmission support with belts	94	56704387	Screw 3,5x16 - 20 pack
24	56704324	Red lens				95	56704388	Screw 4,8x13 tg 20 pack
25	56704325	Main switch						
26	56704326	Switch button						
27	56704327	Handle spring	62	56704401	Pulley, brush with metal insert	96	56704396	Screw 3,5x32 - 20 pack
28	56704328	Handle button	64	56704355	Brush roller 12	97	56704389	Screw 3,9x19 - 20 pack
29	56704329	Clip spring ring	64	56704356	Brush roller 15	98	56704397	Screw 3,9 x13 - 20 pack
30	56704330	Cord 3 wires	65	56704357	Foot pedal	99	56704381	Drive joint / clutch kit
31	56703972	Terminal block 3 poles	66	56704358	Foot pedal spring	100	56704390	Screw 3,9x25 black 20 pack
31	56704400	Terminal block 4 poles	67	56704359	Base lift lever	101	56704391	Screw 2,9x16 - 20 pack
32	56703977	Cord clamp	68	56704360	Base housing dark gray 12			
33	56704331	Cord 3x18 12,5 mt. USA plug - yellow	68	56704361	Base housing dark gray 15	102	56704395	Shaft 5x28 - 20 pack
			69	56704362	Rear wheel assembly	103	56704382	Speed sensor
34	56646865	Handle grip dark gray	70	56704363	Brush adjuster knob	104	56704383	Strain relief black
35	56704332	Chromate tube	71	56703762	Brush adjuster		56704398	Sleeve for extension hose
36	56704333	Buttons +support + springs (kit)	72	56704364	Side cover		56704174	Brush, carbon - vacuum motor
			73	56704365	Roller support			
37	56704334	Extension hose with sleeve	74	56704135	O ring		56703714	Scented pad , pkg. of 10
38	56704213	Telescopic wand	75	56704047	Wheels support		56704392	Paper bag (pkg. of 8 bags + 2 exhaust filters)
39	56703725	Crevice tool	76	56704366	Roller cover clip - 20 pack			
40	56704335	Lens set green + red					54704399	H.E.P.A. filter