



Electronic Service Manuals

This electronic document is provided as a service to our customers. We do not create the contents of the information contained in this document. Should you have detailed questions pertaining to the information contained in this document, you may contact Michco, or the manufacturer which provided the original information in this electronic deliverable. Michco's only part in this electronic deliverable was the electronic assembly process. By providing this manual on line we are not guaranteeing parts availability.

You may contact Michco through the following methods:

Phone (517) 484-9312 or (800) 331-3339

2011 N. High St. -- Lansing, Michigan -- 48906

Fax: (517) 484-9836

Email: CustServe@Michco.com

Web site: www.Michco.Com

Parts Web site: www.FloorMachineParts.Com

Order Parts on Line at:

www.FloorMachineParts.Com

Directly to Parts & Service:

By Email: **Shop@Michco.com**

By Fax: (517) 702-2041

By Voice: Use numbers above.

Serving the Cleaning Industry Since 1922

Notice: All copyrighted material remains property of original owners, all trademarks are property of respective owners. Manuals are subject to Manufacturer's reproduction limitations. Originals or reproductions were provided by manufacturers through a request. We make no warranty as to the correctness of information provided in this document and you assume all risk. By placing these manuals on line we are not declaring our corporation to be an manufacturer authorized dealer or provider, please check our web site for authorized manufacturers we represent.

SIDEWINDER 27 MB

(35.00.152)



- Ⓢ Spare parts catalogue
- Ⓔ *Catálogo de piezas de recambio*
- Ⓕ *Catalogue des pièces de rechange*
- Ⓓ *Ersatzteilkatalog*
- Ⓘ *Catálogo parti di ricambio*



USA

Specifications for ordering spare parts

- 1) Serial number and sweeper type.
- 2) Number of the table
- 3) Part identification code.
- 4) Quantity ordered

Example:

Sidewinder 27 MB

Serial number: 172360

Table: 1

Item: 36 (1.5.11238 - bonnet)

Quantity: 1 Pz.

ES

Normas a observar par los pedidos de recambios

- 1) Número de matrícula y tipo de barredora.
- 2) Número de la tabla de recambios.
- 3) Número de referencia particular.
- 4) Cantidad en orden

Ejemplo:

Sidewinder 27 MB

Matrícula: 172360

Table: 1

Pos.: 36 (1.5.11238 - capot)

Quantity: 1 Pz.

FR

Données à indiquer pour la commande des pièces de rechange

- 1) Numero de matricule et type de la balayeuse.
- 2) Numero de la table
- 3) Numero de la reference de la pièce.
- 4) Quantité commandée

Exemple:

Sidewinder 27 MB

Matricule: 172360

Table: 1

Ligne: 1 (1.5.11238 - capot)

Quantité: 1 Pz.

DE

Bei der Bestellung von Ersatzteilen unbedingt anzugeben

- 1) Fabriknummer und Kehrmaschinentyp.
- 2) Nummer der Ersatzteilstafel.
- 3) Bezugsnummer des Ersatzteiles.
- 4) Bestellte Menge

Beispiel:

Sidewinder 27 MB

Fabriknr: 172360

Tafel: 1

Zeile: 1 (1.5.11238 - Haube)

Menge: 1 Pz.

ITA

Norme da osservare per l'ordinazione delle parti di ricambio

- 1) Numero di matricola e tipo di motoscopa.
- 2) Numero della tavola
- 3) Numero di riferimento del particolare.
- 4) Quantità richiesta

Esempio:

Sidewinder 27 MB

Matricola: 172360

Tavola: 1

Voce: 1 (1.5.11238 - cofano)

Quantità: 1 Pz.

MOTOR-SWEEPER TYPEPLATE.
 PLACA INDICADORA DEL TIPO DE BARREDORA
 PLAQUETTE D'IDENTIFICATION DU TYPE DE LA BALAYEUSE.
 TYPENSCHILD DER KEHRMASCHINE.
 TARGHETTA RIASSUNTIVA DEL TIPO DI MOTOSCOPIA.



nss		CE	
NSS Enterprises, Inc. 3115 FRENCHMANS ROAD, TOLEDO, OH 43607-2928			
SWEEPER			
MODEL	SIDEWINDER 27 MB	WEIGHT	75
SERIAL N°	172360	YEAR	2007
48A	12V.		440W
18 ^{eb}	MADE IN ITALY	FILTER TYPE U	
HEAVY DUTY MACHINES FOR COMMERCIAL OR INDUSTRIAL USE.			

USA

Table list

Table 1 Bodywork
Table 2 Brushes
Table 3 Motor

ES

Lista de las tablas

Tabla 1 Chasis
Tabla 2 Cepillos
Tabla 3 Motor

FR

Liste des tables

Table 1 Coque
Table 2 Broses
Table 3 Moteur

DE

Tafelverzeichnis

Tafel 1 Karosserie
Tafel 2 Bürsten
Tafel 3 Motor

ITA

Elenco delle tavole

Tavola 1 Chasis
Tavola 2 Cepillos
Tavola 3 Motor

SIDEWINDER 27 MB

Bodywork
Chasis
Coque
Karosserie
Scocca

Table n°
Tabla n°
Table n°
Tafel n°
Tavola n°



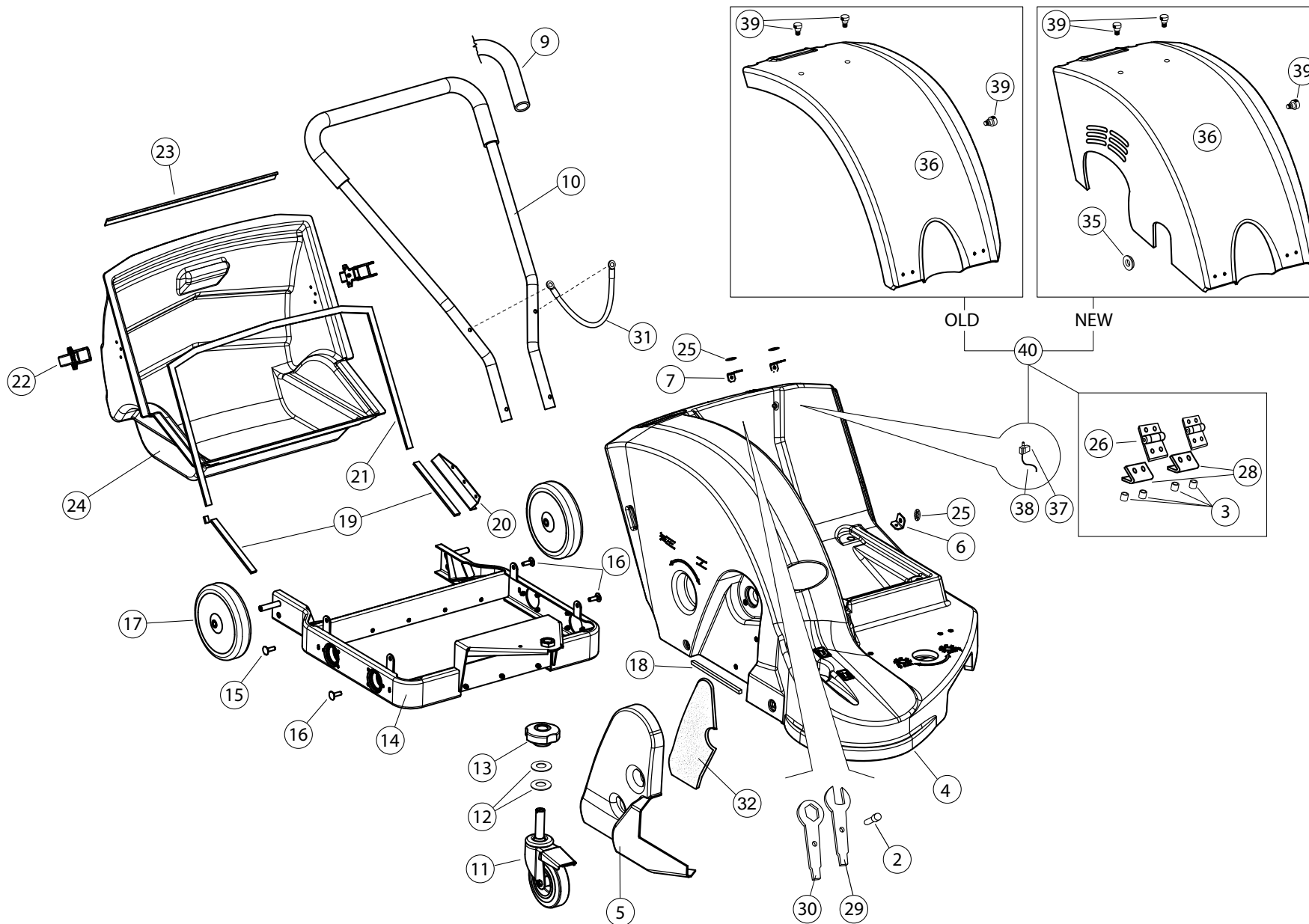

1



SIDEWINDER 27 MB

Table n°
Tabla n°
Table n°
Tafel n°
Tavola n°





1

Part. no°	Code nr.	Quantity	 Description	 Descripción	 Description	 Benennung	 Descrizione	Remarks
Pos. n°	Código n°	Cantidad						Observación
N° pièce	Code n°	Quantité						Notes
Stück Nr.	Code Nr.	Anzahl						Bemerkungen
Pos. n°	Codice n°	Quantità						Observación
1								
2	6298291	1	knob	pomo	poignée	Kugelknopf	pomello	
3	6299351	4	spacer	distanciador	entretoise	Abstandhalter	distanziale	
4	6298011	1	bodywork	chasis	châssis	Rahmengestell	telaio	
5	6298021	1	guard	protección	protection	Schutz	carter	
6	6298031	1	plate	placa	plaque	Platte	piastrino	
7	6298041	2	plate	placa	plaque	Platte	piastrino	
8								
9	6298051	mt 0,80	handlebar guard	protección manillar	protection guidon	Lenkstangenschutz	copertura manubrio	
10	6298061	1	handlebar	manillar	guidon	Lenkstangenschutz	manubrio	
11	6298071	1	front wheel	rueda delantera	roue avant	Vorderrad	ruota anteriore	
12	6298081	2	Belleville spring	arandela Belleville	rondelle Belleville	Spannscheibe	mola a tazza	
13	6298091	1	knob	pomo	poignée	Knopf	pomello	
14	6298101	1	main chassis	chasis principal	châssis principal	Hauptrahmengestell	telaio principale	
15	6298111	1	round head screw	tornillo cabeza redond.	vis à tête ronde	Halbrundschraube	vite TTQ	M8x60
16	6298121	3	round head screw	tornillo cabeza redond.	vis à tête ronde	Halbrundschraube	vite TTQ	M8x30
17	6298131	2	rear wheel	rueda trasera	roue arrière	Hinterrad	ruota posteriore	
18	6298141	mt 0,30	rubber section	perfil en goma	profil en caoutchouc	Gummiprofil	profilo in gomma	
19	6298151	mt 0,45	rubber section	perfil en goma	profil en caoutchouc	Gummiprofil	profilo in gomma	
20	6298161	1	slide	guía	guide	Gleitführung	guida	
21	6298171	mt 1,35	rubber section	perfil en goma	profil en caoutchouc	Gummiprofil	profilo in gomma	
22	6298181	2	lever closing	cerrojo	fermeture à levier	Hebelverschluß	chiusura a leva	
23	6298191	1	strip	listón	plate	Leiste	listello	
24	6298201	1	refuse container	contenedor de basura	bac à déchets	Abfallbehälter	cassetto rifiuti	
25	6299001	2	tooth lock washer	arandela	rondelle	Scheibe	Rondella dentata	
26	6298211	2	hinge	charnela	charnière	Scharnier	cerniera	
27								
28	6298221	2	plate	placa	plaque	Platte	piastrino	
29	6298231	1	Wrench	llave	clé	Schlüssel	chiave multiuso	
30	6298241	1	Wrench	llave	clé	Schlüssel	chiave multiuso	
31	6298251	1	ground	masa	masse	Erdungsgeflecht	massa	

SIDEWINDER 27 MB

Table n°
Tabla n°
Table n°
Tafel n°
Tavola n°

1

Part. no°	Code nr.	Quantity	 Description	 Descripción	 Description	 Benennung	 Descrizione	Remarks
Pos. n°	Código n°	Cantidad						Observación
N° pièce	Code n°	Quantité						Notes
Stück Nr.	Code Nr.	Anzahl						Bemerkungen
Pos. n°	Codice n°	Quantità						Observación
32	6299361	1	antinoise panel	panel de insonorización	panneau d'insonorisation	Soundproofingverkleidung	pannello antirombo	
33								
34								
35	6290591	1	washer FROM SERIAL NR.	arandela DESDE LA MATRICULA	rondelle À PARTIR DU N.SÉRIE	Scheibe VON SERIEN-NR.	rondella DA MATRICOLA	178084
36	6298261	1	hinged bonnet UP TO SERIAL NR.	capot basculante HASTA LA MATRICULA	capot rebattable JUSQU' À AU N.SÉRIE	Kippbarem Haube BIS SERIEN-NR.	cofano ribaltabile FINO MATRICOLA	178083
36	6299451	1	hinged bonnet FROM SERIAL NR.	capot basculante DESDE LA MATRICULA	capot rebattable À PARTIR DU N.SÉRIE	Kippbarem Haube VON SERIEN-NR.	cofano ribaltabile DA MATRICOLA	[+ 6290591 INTERCHAN. WITH 6298261] 178084
37	6298271	1	microswitch	micro interruptor	microinterruteur	Mikroschalter	microinterruttore	
38	6298281	1	microswitch electr.cable	cable eléctrico	câble électrique	Elektrokabeln	cablaggio per micro	
39	6298291	3	knob	pomo	poignée	Handrad	volantino	
40	6298301	1	bonnet opening kit (WITH MICROSWITCH) UP TO SERIAL NR.	Kí abertura capot (CON MICRO INTERR.) HASTA LA MATRICULA	kit ouverture de capot (AVEC MICROINTERR.) JUSQU' À AU N.SÉRIE	Kit Haubeöffnunk (MIT MIKROSCHALTER) BIS SERIEN-NR.	kit ribaltamento cofano (CON MICROINTERR.) FINO MATRICOLA	178083
40	6299461	1	bonnet opening kit (WITH MICROSWITCH) FROM SERIAL NR.	Kí abertura capot (CON MICRO INTERR.) DESDE LA MATRICULA	kit ouverture de capot (AVEC MICROINTERR.) À PARTIR DU N.SÉRIE	Kit Haubeöffnunk (MIT MIKROSCHALTER) VON SERIEN-NR.	kit ribaltamento cofano (CON MICROINTERR.) DA MATRICOLA	INTERCHANGEABLE WITH 6298301 178084
41								
42								
43								
44								
45								
46								
47								
48								
49								
50								
51								
52								
53								
54								

SIDEWINDER 27 MB

Brushes
Cepillos
Brosses
Bürsten
Spazzole



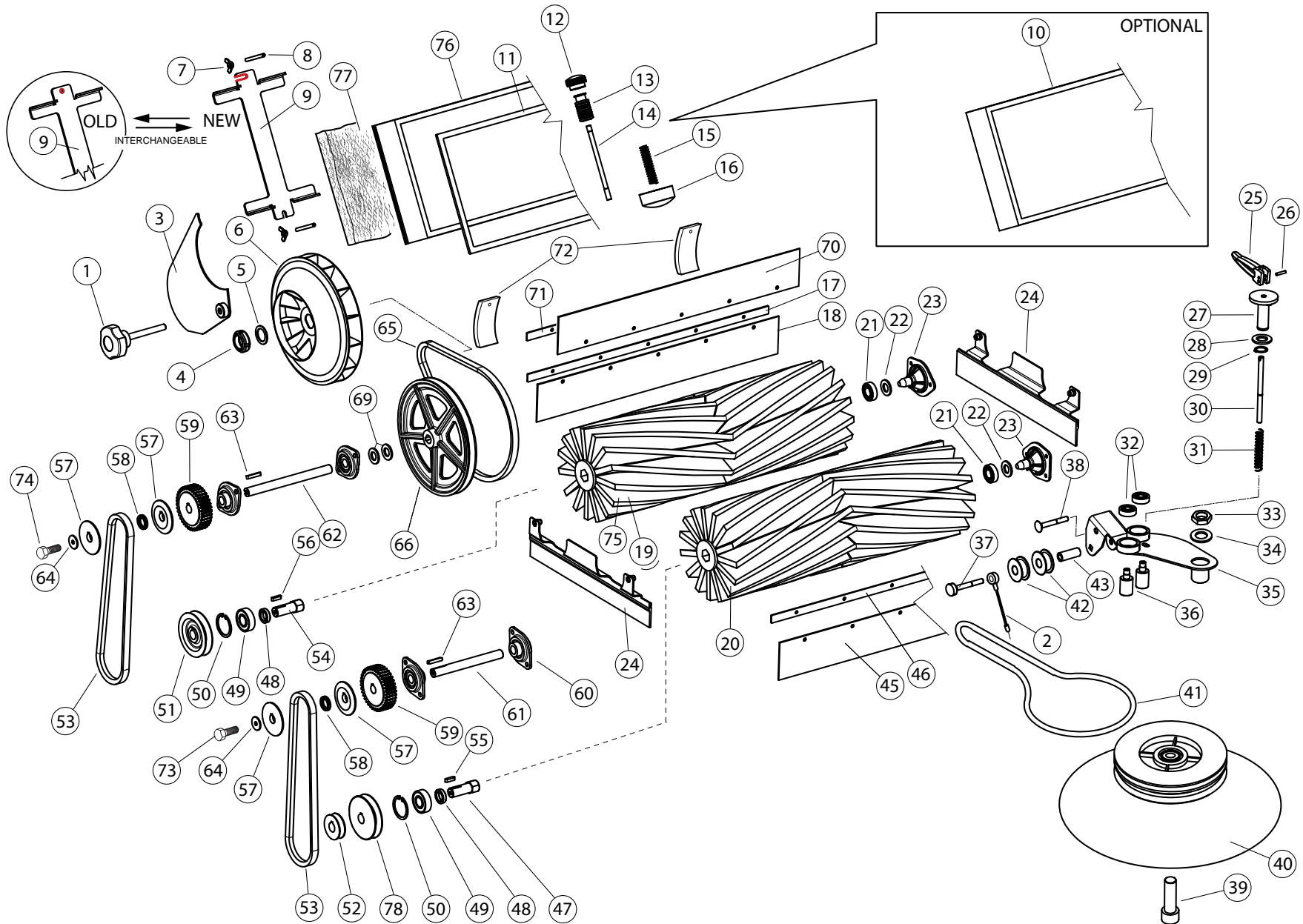

Table n°
Tabla n°
Table n°
Tafel n°
Tavola n°



SIDEWINDER 27 MB

Table n°
Tabla n°
Table n°
Tafel n°
Tavola n°

2

Part. no°	Code nr.	Quantity	 Description	 Descripción	 Description	 Benennung	 Descrizione	Remarks
Pos. n°	Código n°	Cantidad						Observación
N° pièce	Code n°	Quantité						Notes
Stück Nr.	Code Nr.	Anzahl						Bemerkungen
Pos. n°	Codice n°	Quantità						Observación
1	6298311	1	knob	pomo	poignée	Knopf	pomello	
2	6298321	1	earth lead	cable de puesta a masa	cable de masse	Masseleitung	cavo massa	
3	6298331	1	vacuum closing	cierre aspiración	fermeture aspiration	Ansaugung-Verschlußdeckel	chiusura aspirazione	
4	6298341	1	ring nut	anillo roscado	collier	Nutmutter	ghiera	
5	6298351	1	washer	aranela	rondelle	Scheibe	rondella	
6	6298361	1	vacuum fan	ventilador de aspiración	turbine d'aspiration	Ansaugventilator	ventola aspirazione	
7	6298371	2	wing nut	tuerca	écrou papillon	Flügelmutter	dado ad alette	
8	6298381	2	tie-rod	tirante	tirant	Zugbolzen	tirante	
9	6298391	1	support	soporte	support	Halterung	supporto	
10	6298401	1	cellulose panel filter	filtro de panel en celulosa	filtre à panneau en cellulose	Zellulose Flachfilter	filtro a pannelo in cellulosa	optional
10	6298411	1	polyester panel filter	filtro de panel en poliéster	filtre à panneau en polyester	Polyester Flachfilter	filtro a pannelo in poliester	optional
11	6298421	mt 1,55	rubber section	Perfil en goma	profil en caoutchouc	Gummiprofil	profilo in gomma	
12	6298431	1	knob	pomo	poignée	Knopf	pomello	
13	6298441	1	bellows	fuelle	soufflet	Gebläse	soffietto	
14	6298451	1	tie-rod	tirante	tirant	Zugbolzen	tirante	
15	6298461	1	spring	muelle	ressort	Feder	molla	
16	6298471	1	filter striker	Martillo vibrador	vérin à secouer le filtre	Rüttlerkopf	martelletto	
17	6298481	1	strip	listón	plate	Leiste	listello	
18	6298491	1	rear flap	Goma prot de polvo delan.	bavette arrière	Staubhalte Gummiprofil	gomma parap. posteriore	
19	6298981	1	main brush	Cepillo central	brosse centrale	Hauptbürste	spazzola centrale	PPL 0,3
19	6298501	1	main brush	Cepillo central	brosse centrale	Hauptbürste	spazzola centrale	PPL / bronze (Optional)
20	6298991	1	main brush	Cepillo central	brosse centrale	Hauptbürste	spazzola centrale	PPL 0,7
20	6298511	1	main brush	Cepillo central	brosse centrale	Hauptbürste	spazzola centrale	PPL / bronze (Optional)
21	6298521	2	bearing	cojinete	roulement	Lager	cuscinetto	
22	6298531	2	washer	arandela	rondelle	Scheibe	rondella	
23	6298541	2	support	soporte	support	Halterung	supporto	
24	6298551	2	side flap	goma lateral	bavette latérale	Seitengummi	flap laterale	
25	6298561	1	lever	palanca	levier	Hebel	leva	
26	6298571	1	spring pin	perno tallado	goupille élastique	Spannstift	spina elastica	Ø4
27	6298581	1	bush	Bujie	douille	Buchse	boccola	
28	6298591	1	spacer	distanciador	entretoise	Abstandhalter	distanziale	
29	6298601	1	washer	arandela	rondelle	Scheibe	rondella	Ø8

SIDEWINDER 27 MB

Table n°
Tabla n°
Table n°
Tafel n°
Tavola n°

2

Part. no° Pos. n°	Code nr. Código n°	Quantity Candidad	(USA) Description	(ES) Descripción	(FR) Description	(DE) Benennung	(ITA) Descrizione	Remarks Observación Notes Bemerkungen Observación
30	6298611	1	pin	perno	pivot	Bolzen	perno	
31	6298621	1	spring	muelle	ressort	Feder	molla	
32	6298631	2	bearing	cojinete	roulement	Lager	cuscinetto	
33	6298641	1	nut	tuerca	écrou	Mutter	dado	M20x2,5
34	-	1	washer	aranela	rondelle	Scheibe	rondella	Ø20
35	6298651	1	arm	brazo	bras	Arm	braccio	
36	6298661	1	pin	perno	pivot	Bolzen	perno	
37	6298671	1	hex.head screw	tornillo de cabeza hexag.	vis à six pans	Sechskantschraube	vite TE	M8x70
38	6298681	1	round head screw	tornillo cabeza redond.	vis à tête ronde	Halbrundschraube	vite TTQ	M10x110
39	-	1	hex.head screw	tornillo de cabeza hexag.	vis à six pans	Sechskantschraube	vite TE	M8x2,5x40
40	6298691	1	sider brush	cepillo lateral	brosse latérale	Seitenbürste	spazzola laterale	PPL 0,5
40	6298701	1	sider brush (optional)	cepillo lateral (opcional)	brosse latérale (optionelle)	Seitenbürste (Option)	spazzola laterale (optional)	PPL/acciaio - steel - acier - Stahl - acciaio
41	6298711	1	belt	correa	courroie	Riemen	cinghia	
42	6298721	2	pulley	polea	polea	Scheibe	rochetto	
43	6298731	1	spacer	distanciador	entretoise	Abstandhalter	distanziale	
44								
45	6298491	1	front flap	goma delantera	bavette avant	Staubhalte-Vordergummi	flap anteriore	optional
46	6298751	1	strip	listón	plate	Leiste	listello	optional
47	6298761	1	axle	eje	axe	Achse	albero	
48	6298771	2	spacer	distanciador	entretoise	Abstandhalter	distanziale	
49	6298781	2	bearing	cojinete	roulement	Lager	cuscinetto	
50	6298791	2	seeger	anillo de retención	bague d'étanchéité	Seegerring	anello d'arresto	
51	6298801	1	pulley	polea	poulie	Riemenscheibe	puleggia	
52	6298811	1	pulley	polea	poulie	Riemenscheibe	puleggia	
53	6298821	2	belt	correa	courroie	Riemen	cinghia	
54	6298831	1	axle	eje	axe	Achse	albero	
55	-	1	key	chaveta	clavette	Keil	chiavetta	5x5x35
56	6298841	1	key	chaveta	clavette	Keil	chiavetta	5x5x20
57	6298851	4	half-pulley	semi-polea	demi-poulie	Halbriemenscheibe	semi-puleggia	
58	6298861	10	washer	aranela	rondelle	Scheibe	rondella	
59	6298871	2	gear	engranaje	engrenage	Zahnradgetriebe	ingranaggio	
60	6298881	4	bearing	cojinete	roulement	Lager	supporto orientabile	

SIDEWINDER 27 MB

Table n°
Tabla n°
Table n°
Tafel n°
Tavola n°

2

Part. no° Pos. n°	Code nr. Código n°	Quantity Candidad	(USA) Description	(ES) Descripción	(FR) Description	(DE) Benennung	(ITA) Descrizione	Remarks Observación Notes Bemerkungen Observación
61	6298891	1	axle	eje	axe	Achse	albero	
62	6298901	1	axle	eje	axe	Achse	albero	5x5x30
63	6298911	2	key	chaveta	clavette	Keil	chiavetta	5x5x30
64	6298921	2	washer	aranela	rondelle	Scheibe	rondella	Ø6
65	6298931	1	belt	correa	courroie	Riemen	cinghia	
66	6298941	1	pulley	polea	poulie	riemenscheibe	puleggia	
67	6298951	1	O-ring	anillo OR	anneau OR	OR Ring	anello OR	
68								
69	-	2	washer	arandela	rondelle	Scheibe	rondella	Ø 15x30x3
70	6299011	1	rear flap	Goma prot de polvo delan.	bavette arrière	Staubhalte Gummiprofil	gomma parap. posteriore	
71	6299021	1	flat bar	listón	bande	Leiste	listello	
72	6299031	2	antistatic flap	goma antiestática	caoutchouc antistatique	Antistatikum Gummi	flap antistatico	
73	6299041	1	hex.head screw (special)	tornillo de cabeza hex.	vis à tête à six pans	Sechskantschraube	vite TE filetto sinistro	M6x20
74	6299051	1	hex.head screw	tornillo de cabeza hex.	vis à tête à six pans	Sechskantschraube	vite TE	M6x20
75	6299061	1	main brush	cepillo central	brosse centrale	Hauptbürste	spazzola centrale	PPL 0,5 optional
76	6299071	1	panel filter with (velcro strip)	filtro panel (banda velcro)	filtre panneau (bande velcro)	Flachfilter (Bande Velcro)	filtro a pannello con velcro	
77	6299081	1	filter element	elemento filtrante	élément filtrant	Filterelement	elemento filtrante	
78	6299431	1	pulley	polea	poulie	Riemenscheibe	puleggia	
79								
80								
81								
82								
83								
84								
85								
86								
87								
88								
89								
90								
91								
92								

SIDEWINDER 27 MB

Motore
Motor
Moteur
Motor
Motor

Table n°
Tabla n°
Table n°
Tafel n°
Tavola n°



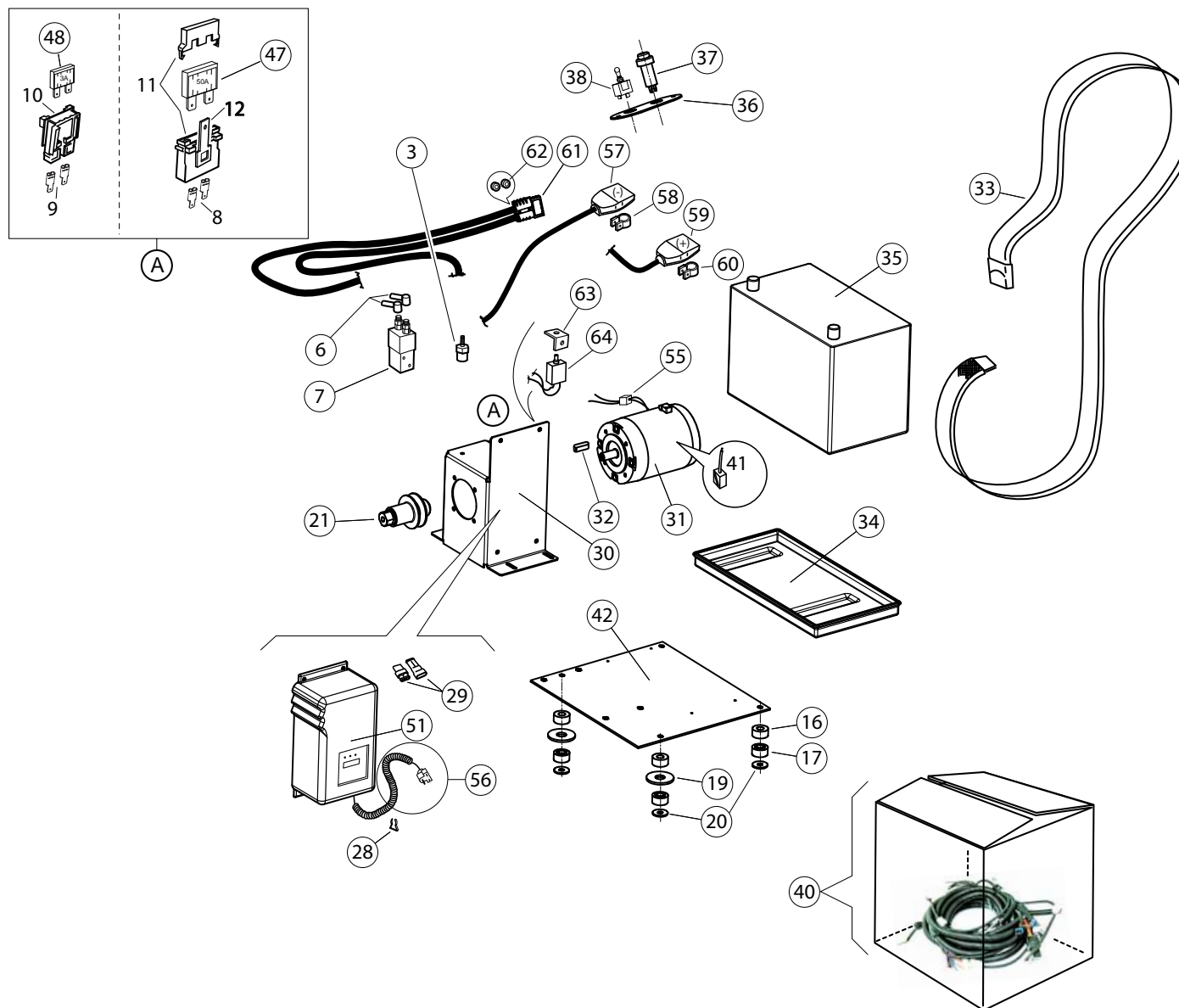

3



SIDEWINDER 27 MB

Table n°
Tabla n°
Table n°
Tafel n°
Tavola n°

3

Part. no°	Code nr.	Quantity	 Description	 Descripción	 Description	 Benennung	 Descrizione	Remarks
Pos. n°	Código n°	Cantidad						Observación
N° pièce	Code n°	Quantité						Notes
Stück Nr.	Code Nr.	Anzahl						Bemerkungen
Pos. n°	Codice n°	Quantità						Observación
1								
2								
3	6299091	1	insulator	aislador	isolateur	Isolator	isolatore	
4								
5								
6	6299101	2	cap	protección	protection	Schutz	cappuccio	
7	6299111	1	remote control switch	telerruptor	télérupteur	Fernschalter	teleruttore	
8	6299381	2	terminal UP TO SERIAL NR.	terminal HASTA LA MATRICULA	borne JUSQU' À AU N.SÉRIE	Klemme BIS SERIEN-NR.	terminale FINO MATRICOLA	178083
9	6299391	2	terminal	terminal	borne	Klemme	terminale	
10	6299401	1	fuse box	caja de fusible	boîter à fusible	Sicherungskaten	portafusibile	
11	6299411	1	fuse box UP TO SERIAL NR.	caja de fusible HASTA LA MATRICULA	boîter à fusible JUSQU' À AU N.SÉRIE	Sicherungskaten BIS SERIEN-NR.	portafusibile FINO MATRICOLA	178083
12	6299421	1	bracket UP TO SERIAL NR.	estribo HASTA LA MATRICULA	bride JUSQU' À AU N.SÉRIE	Bugel BIS SERIEN-NR.	staffa FINO MATRICOLA	178083
13								
14								
15								
16	6299121	4	shock absorbing ring	anillo amortiguador	anneau amortisseur	Stosssdaempfering	anello ammortizzatore	
17	6299131	4	shock absorbing ring	anillo amortiguador	anneau amortisseur	Stosssdaempfering	anello ammortizzatore	
18								
19	6299141	2	washer	arandela	rondelle	Scheibe	rondella	
20	6299151	4	washer	arandela	rondelle	Scheibe	rondella	Ø8
21	6299161	1	pulley	polea	poulie	Riemenscheibe	puleggia	
22								
23								
24								
25								
26								
27								
28	6292921	1	cable retainer	retén de cable	arretoir de câble	Kabelhalter	fermo cavo	
29	6299171	1	battery charger connectors	conectores de cargador	connecteurs du chargeur	Steckverbinder für ladegerät	connettori x carica batteria	

SIDEWINDER 27 MB

Table n°
Tabla n°
Table n°
Tafel n°
Tavola n°

3

Part. no° Pos. n°	Code nr. Código n°	Quantity Candidad	(USA) Description	(ES) Descripción	(FR) Description	(DE) Benennung	(ITA) Descrizione	Remarks Observación Notes Bemerkungen Observación
30	6299181	1	support	soporte	support	Halterung	supporto	
31	6296151	1	electric motor	motor eléctrico	moteur électrique	Elektromotor	motore elettrico	
32	6299191	1	key	chaveta	clavette	Keil	chiavetta	5x5x20
33	6299201	1	tightening belt	correa de proteccion	courroie de protection	Schutzband	cinghia	
34	6299211	1	battery container	caja de la batería	panier de batteries	Batterietrog	vaschetta	
35	2392111	1	battery	Batería	batterie	Batterie	batteria	12V-85Ah Optional
36	6299231	1	instrument panel	salpicadero	tableau de bord	Armaturenbrett	supporto strumentazione	
37	6299241	1	battery warning light	testigo bateria	témoin batterie	Kontrolleuchte- Batterie	spia carica batteria	
38	6291541	1	starter switch	interruptor de arranque	interrupteur de démarrage	Anlaßschalter	interruttore avviamento	
39								
40	6299251	1	electric system assembly	Instalación eléctrica comp	ensem install électrique	Komp. Elektrisches System	assieme impianto elettrico	
41	6292941	1	carbon set	seria carbones	kit charbons	Kohlenbürstensatz	serie carboncini	
42	6299261	1	support	soporte	support	Halterung	supporto	
43								
44								
45								
46								
47	6299274	1	fuse # USE 6297361	fusible	fusible	Sicherung	fusibile	30A Maxi [see 50A Fuse]
47	6297361	1	fuse UP TO SERIAL NR.	fusible HASTA LA MATRICULA	fusible JUSQU' À AU N.SÉRIE	Sicherung BIS SERIEN-NR.	fusibile FINO MATRICOLA	50A Maxi 178083
48	6299281	1	fuse	fusible	fusible	Sicherung	fusibile	3A
49								
50								
51	6297561	1	battery charger	cargador de bateria	chargeur de la batterie	Batterieladegerät	carica batterie	
52								
53								
54								
55	6299291	1	ferrite	ferrita	ferrite	Ferrit	ferrite	
56	6299411	1	coiled cord+plug	cable+toma	câble+connecteur	Kabel+Stecker	cavo+spina americana	
57	6299301	1	terminal cover	protección terminal	cache-borne	Klemmendeckel	coprimorsetto	(-)
58	6299311	1	terminal	terminal	borne	Klemme	morsetto	(-)
59	6299321	1	terminal cover	protección terminal	cache-borne	Klemmendeckel	coprimorsetto	(+)

O



NSS ® Enterprises, Inc.

3115 Frenchmens Road, Toledo, Ohio 43607

PHONE: (419) 531-2121 FAX: (419) 531-3761

NSS ® Enterprises, Inc. European Distribution Centre

Unit II Pinfold Trading Estate * 55 Nottingham Road

STAPLEFORD NOTTINGHAM NG9 8AD ENGLAND U.K.

PHONE: (44) 0115 939 1568 * FAX: (44) 0115 949 0615

SIDEWINDER 27 MB SWEEPER ILLUSTRATED PARTS BOOK

ORIG. 07-07 REV. _ 01-09 **9096227**
