



## Electronic Service Manuals

This electronic document is provided as a service to our customers. We do not create the contents of the information contained in this document. Should you have detailed questions pertaining to the information contained in this document, you may contact Michco, or the manufacturer which provided the original information in this electronic deliverable. Michco's only part in this electronic deliverable was the electronic assembly process. By providing this manual on line we are not guaranteeing parts availability.

You may contact Michco through the following methods:

Phone (517) 484-9312 or (800) 331-3339

2011 N. High St. -- Lansing, Michigan -- 48906

Fax: (517) 484-9836

Email: [CustServe@Michco.com](mailto:CustServe@Michco.com)

Web site: [www.Michco.Com](http://www.Michco.Com)

Parts Web site: [www.FloorMachineParts.Com](http://www.FloorMachineParts.Com)

Order Parts on Line at:

**[www.FloorMachineParts.Com](http://www.FloorMachineParts.Com)**

Directly to Parts & Service:

By Email: **[Shop@Michco.com](mailto:Shop@Michco.com)**

By Fax: (517) 702-2041

By Voice: Use numbers above.

**Serving the Cleaning Industry Since 1922**

Notice: All copyrighted material remains property of original owners, all trademarks are property of respective owners. Manuals are subject to Manufacturer's reproduction limitations. Originals or reproductions were provided by manufacturers through a request. We make no warranty as to the correctness of information provided in this document and you assume all risk. By placing these manuals on line we are not declaring our corporation to be an manufacturer authorized dealer or provider, please check our web site for authorized manufacturers we represent.

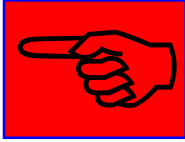

# ALTO<sup>®</sup>

CLARKE  
TECHNOLOGY

## Operator's Manual

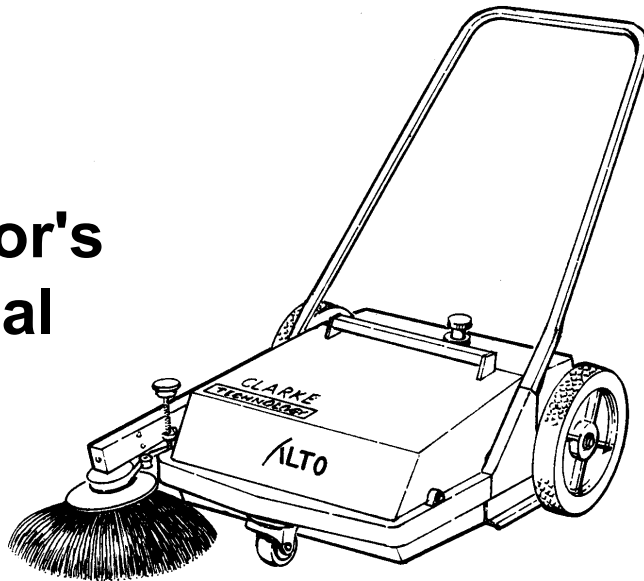

## PS-27 Sweeper

### READ THIS BOOK

This book has important information for the use and safe operation of this machine. Failure to read this book prior to operating or attempting any service or maintenance procedure to your ALTO machine could result in injury to you or to other personnel; damage to the machine or to other property could occur as well. You must have training in the operation of this machine before using it. If your operator(s) cannot read English, have this manual explained fully before attempting to operate this machine.

Si Ud. o sus operadores no pueden leer el Inglés, se hagan explicar este manual completamente antes de tratar el manejo o servicio de esta máquina.

All directions given in this book are as seen from the operator's position at the rear of the machine.

For new books write to: ALTO U.S. Inc., 2100 Highway 265, Springdale, Arkansas 72764.







## Table of Contents

Operator Safety Instructions .....	1
Introduction & Machine Specifications .....	2
How to Assemble the PS-27 .....	3
How to Operate the Machine .....	3
Maintenance .....	4
SECTION II Parts and Service Manual	
Assembly drawing .....	6
Parts List .....	7

## OPERATOR SAFETY INSTRUCTIONS



<b>DANGER</b> means:	Severe bodily injury or death can occur to you or other personnel if the <b>DANGER</b> statements found on your machine or in your Owner's Manual are ignored or are not adhered to. Read and observe all <b>DANGER</b> statements found in your Owner's Manual and on your machine.
<b>WARNING</b> means:	Injury can occur to you and to other personnel if the <b>WARNING</b> statements found on your machine or in your Owner's Manual are ignored or are not adhered to. Read and observe all <b>WARNING</b> statements found in your Owner's Manual and on your machine.
<b>CAUTION</b> means:	Damage can occur to the machine or to other property if the <b>CAUTION</b> statements found on your machine or in your Owner's Manual are ignored or are not adhered to. Read and observe all <b>CAUTION</b> statements found in your Owner's Manual and on your machine.

-  **DANGER:** Failure to read the Operator's Manual prior to using this machine could result in injury to you or to other personnel; damage to the machine or to other property could occur as well. You must have training in the operation of this machine before using it. If you or your operator(s) cannot read English, have this manual explained fully before attempting to operate this machine
-  **DANGER:** Operating a machine that is not completely or fully assembled could result in injury or property damage. Do not operate this machine until it is completely assembled.
-  **WARNING:** This machine is not usable for liquids or hazardous materials. To avoid injury to persons or damage to the machine, do not use this machine with liquids or hazardous materials.
-  **WARNING:** To avoid injury to personnel or damage to machine, do not leave this machine on a ramp or dock.
-  **WARNING:** Failure to read and observe all safety statements found on your machine or in this Operator's Manual can result in serious injury or damage. Read and observe all safety statements. Make sure that all labels, decals, warnings, cautions, and instructions are fastened to the machine. Get new labels from your authorized Clarke distributor.
-  **CAUTION:** When the machine is delivered, carefully inspect the shipping carton and the machine for damage. If damage is evident, save the shipping carton so that it can be inspected by the trucking company that delivered it. Contact the trucking company immediately to file a damage claim. Make sure all loose parts and literature are removed before the shipping carton is discarded.
-  **CAUTION:** Maintenance and repairs performed by unauthorized personnel could result in damage or injury. Maintenance and repairs performed by unauthorized personnel will void your warranty. Servicing of this unit must always be referred to an authorized Clarke distributor.

## Introduction and Machine Specifications

The PS-27 is many times faster than conventional cleaning with a push broom. The side broom allows for cleaning along curbs or walls and in corners. There is no engine or motor, no noise, and no odor. The push sweeper requires no maintenance. The hopper can be emptied easily and rapidly.

The PS-27 can be used anywhere, anytime....indoors or outdoors for concrete, tile and commercial carpets.

### Machine Specifications:

<b>Sweeping Width</b>	27" with side broom
<b>Main Broom</b>	10" x 19" - adjustable height
<b>Side Broom</b>	13" - polypropylene bristles - adjustable height
<b>Hopper Capacity</b>	10 Gallons (1.5 Bushels)
<b>Wheels</b>	12" semi-pneumatic, non-slip tires
<b>Casters</b>	3" rubber, heavy-duty ball bearing
<b>Dimensions</b>	Height 36" (floor/top of handle) Width 30 <sup>3</sup> / <sub>8</sub> " (wheel/outside of side broom) Length 53" (handle/side broom) 41" (excluding handle)
<b>Output</b>	22,000 sq. ft./hr.
<b>Unit Weight</b>	71 lbs.
<b>Shipping Dimensions</b>	35 <sup>7</sup> / <sub>8</sub> " x 28 <sup>3</sup> / <sub>8</sub> " x 7 <sup>3</sup> / <sub>4</sub> "
<b>Shipping Weight</b>	82.5 lbs.

---

## HOW TO ASSEMBLE THE PS-27

1. Remove the four (4) handle mounting screws from the handle brackets on the machine.
2. Slide the handle over the angle brackets. Line up the holes in the handle with the holes in the handle brackets and reinstall the four (4) screws.
3. Pull the handle on top of the hopper upward and lift the hopper off of the machine.
4. Lower the side broom into the side broom bracket so that the holes in the bracket are lined up with the hole in the arm.
5. Slide the pin (from the hardware package) through the holes in the bracket and into the arm. Position the pin so that it is centered on the bracket.
6. Install the black Phillips head screw on the side broom. Tighten the screw to hold the pin in place.
7. Lift the right, rear wheel off of the ground and put the belt around the pulley on the inside of the wheel. Pivot the side broom arm all the way up.
8. Pull the belt towards the front of the machine and twist the belt  $\frac{1}{4}$  turn counter-clockwise (the part of the belt from the top of the rear wheel should move away from the machine.)
9. Lift the belt so that it is outside of the side broom arm and install it around the side broom pulley.
10. Route the belt between the two (2) white plastic pulleys.
11. Install the side broom on the side broom arm using the three (3) screws and the three (3) lockwashers.
12. Lower the side broom arm and position the belt so that it runs through the side broom arm.
13. Screw the side broom adjustment knob into the side broom arm. Adjust the knob so that about  $\frac{1}{3}$  of the side broom bristles are touching the floor.
14. Loosen the two (2) screws that hold the side broom bracket against the chassis. Make sure that the height adjustment screw is between the edges of the stop bracket on the frame.
15. Pull the side broom forward as far as the belt will allow, and tighten the screws.

---

## HOW TO OPERATE THE PS-27 SWEEPER

1. Adjust the height of the main sweeping broom so that the bristles just touch the floor. **NOTE:** Sweeping performance will be poor and the machine will be hard to push if the main broom is set too low.
2. Lower the side broom when sweeping along curbs or walls. **NOTE:** Adjust the side broom height so that  $\frac{1}{3}$  of the bristles are touching the floor.
3. Push the machine forward to enable the main broom to kick dirt and debris into the dirt hopper. **NOTE:** The machine will not sweep when it is pulled backward.
4. Lift the hopper off of the machine and empty it after each use, or whenever debris is left behind the machine.

---

## MAINTENANCE

### Monthly:

1. Tip the machine on its side and remove any string that is wrapped around the main sweeping broom.
2. Lubricate the front caster wheel with light machine oil.
3. Inspect the rubber skirt on the hopper. Replace the skirt if it is torn.

### Every Six Months:

1. Inspect the rubber skirts on each side and behind the sweeping broom. Replace the skirt if it is torn.
2. Tip the machine on its side and inspect the main broom for wear. Replace the broom when the bristles are worn to a length of 1½ inch (38MM).

### Renewal of the Broom Assemblies:

1. The broom roller consists of a broom shaft with three broom supports, one lock washer with a hollow screw and ten (10) broom assemblies as follows:
  - (5) broom assemblies with bristles of 0.006 in. (0.15MM).
  - (5) broom assemblies with bristles of 0.01 in. (0.25MM).

### Broom Assembly Replacement:

1. Unscrew the cap screw (Allen Key, 0.2 in. - 5MM).
2. Turn the lock washer slightly until the notch at the end of the broom assemblies are placed next to each other.
3. Pull the broom assembly to the left to unlock it from the broom supports on the broom shaft.
4. Turn the lock washer and remove the broom assembly.
5. Insert the new broom assemblies onto the shaft so that the 0.006 in. (0.15MM) and 0.01 in (0.25MM) bristles are alternated.



**PS-27**  
**Sweeper**  
Section II  
**Parts and Service Manual**

(78321B)

**CLARKE TECHNOLOGY**  
**Model PS-27 Sweeper**  
**Assembly Drawing - 12/98**

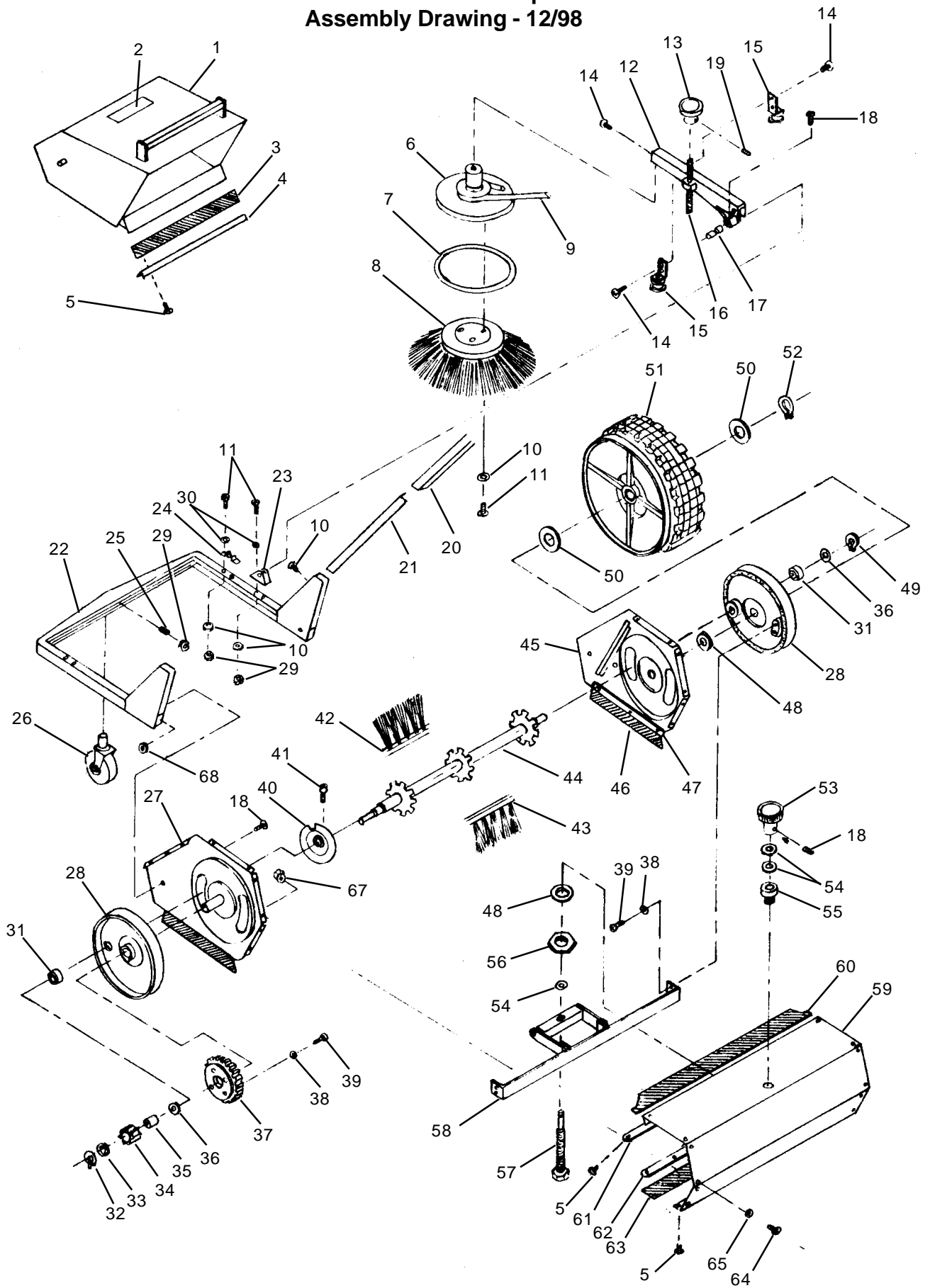

**CLARKE TECHNOLOGY**  
**Model PS-27 Sweeper**  
**Parts List - 12/98**

Ref.	Part No.	Description	Qty.				
1	54867A	Hopper Assembly	1	35	51820A	Clutch	1
2	77371A	Decal	1	36	980679	Washer 2.0 x 17.6 x 32	3
3	56430A	Skirt Hopper	1	37	54412A	Gear, Nylon	1
4	57359A	Retainer, Skirt	1	38	980442	M5 Spring Washer	4
5	964046	Screw, M4 x 0.7 x 10	30	39	964004	Screw 5 x 16	4
6	57237A	Pulley Assembly	1	40	56433A	Brush Support	1
7	51608A	Bumper, Side Broom	1	41	964012	M6 Socket Cap Screw	1
8	50504A	Broom, Side	1	42	56434A	Brush Rails 0.15 MM	5
9	50911A	"V" Belt	1	43	56435A	Brush Rails 0.25 MM	5
10	59854A	M6 Spring Washer	13	44	58315A	Shaft	1
11	964007	Screw M6 x 16	15	45	50421A	Panel, Right	1
12	50130A	Arm, Weldment	1	46	56436A	Skirt, Side	2
13	55522A	Knob, Side Broom	1	47	57360A	Retainer, Skirt	2
14	964053	Screw, M6 x 12	16	48	980630	Washer, 2.0 x 21, 1 x 40.1	3
15	54718A	Idler Assembly	2	49	57840A	Ring S-17	1
16	58804A	Stud Adjustment	1	50	980644	Washer, 2.0 x 16.4 x 32	4
17	50419A	Pin, Arm	1	51	59927A	Tire 12"	2
18	964005	Screw, M5 x 0.8 x 10	5	52	57841A	Ring S-16	2
19	962241	Socket Set, 10-24 x 1/2	2	53	55523A	Knob, Main Broom	1
20	54911A	Handle	1	54	980615	Washer, 1.2 x 10.5 x 25.4	3
21	56431A	Angle Handle	2	55	50422A	Pivot Assembly	1
22	53968A	Frame Weldment	1	56	920334	Nut, 1/2 PT.	1
23	50505A	Bracket, Side Broom	1	57	58805A	Stud, Adjustment	1
24	54230A	Guide, Hopper	2	58	50506A	Bracket	1
25	962337	Socket Set, 1/4-20 x 1/2	1	59	50423A	Panel, Cover	1
26	52115A	Caster 3" Assembly	1	60	56438A	Skirt, Hopper Upper	1
27	50420A	Panel, Left	1	61	57361A	Skirt, Retainer Upper	1
28	56432A	Shroud	2	62	56437A	Skirt, Retainer Lower	1
29	92400A	Nut, M6 x 1.0	7	63	56437A	Skirt, Lower	1
30	980646	Flat Washer M6	6	64	964047	Screw, M4 x 0.7	12
31	902550	Bearing, 620322 ZZ	3	65	980257	Washer, Hopper	12
32	57839A	Ring S-12	1	67	924002	Nut, M4	
33	980648	Washer, 1.5 x 13.1 x 23	1	68	924004	Nut, M5	2
34	57000A	Pinion	1				



# ALTO® PRODUCT SUPPORT BRANCHES

## U. S. A. Locations

### HEAD OFFICE

ALTO U.S. Inc., St. Louis, Missouri  
16253 Swingley Ridge Road, Suite 200  
Chesterfield, Missouri 63017-1725

### PRODUCTION FACILITIES

ALTO U.S. Inc., Springdale, Arkansas  
2100 Highway 265  
Springdale, Arkansas 72764  
(501) 750-1000  
**Customer Service - 1-800-253-0367**  
**Technical Service - 1-800-356-7274**

ALTO U.S. Inc., Bowling Green, Ohio 43402  
1100 Haskins

ALTO U.S. Inc., Clearwater, Florida 33765  
1500 N. Belcher Road

### SERVICE FACILITIES

ALTO U.S. Inc., Carlstadt, New Jersey 07072  
150 Commerce Road  
(201) 460-4774

ALTO U.S. Inc., Elk Grove, Illinois 60007  
2280 Elmhurst Road  
(847) 956-7900

ALTO U.S. Inc., Denver, Colorado 80204  
1955 West 13th Ave.  
(303) 623-4367

ALTO U.S. Inc., Houston, Texas 77040  
7215 North Gessner Road

### SALES AND SERVICE FACILITIES

ALTO U.S. Inc., Madison Heights, Michigan 48071-0158  
29815 John R.  
(810) 544-6300

ALTO U.S. Inc., Marietta, Georgia 30062  
1355 West Oak Common Lane  
(770) 973-5225

---

**CLARKE TECHNOLOGY**  
**AMERICAN SANDERS TECHNOLOGY**  
**A.L. COOK TECHNOLOGY**  
**Customer Service Headquarters and Factory**  
2100 Highway 265  
Springdale, Arkansas 72764  
(501) 750-1000

**Technical Service**  
1-800-356-7274

## European Locations

### PRODUCTION FACILITIES

ALTO Danmark A/S, Aalborg  
Blytaekkervej 2  
DK-9000 Aalborg  
+45 72 18 21 00

ALTO Danmark A/S, Hadsund  
Industrivarveret  
DK-9560 Hadsund  
+45 72 18 21 00

### SALES SUBSIDIARIES

ALTO Canada Ltd., Rexdale Ontario  
24 Constellation Ct.  
(416) 675-5830

ALTO Overseas Inc., Sydney (Australia)  
1B/8 Resolution Drive  
Caringbah NSW 2229  
+61 2 9524 6122

ALTO Cleaning Systems Asia Pte Ltd., Singapore  
No. 17 Link Road  
Singapore 619034  
+65 268 1006

ALTO Deutschland GmbH, Frondenberg (Germany)  
Ardeyer Str. 15  
D-58730 Frondenberg  
+49 2373 754 200

ALTO Cleaning Systems (UK) Ltd., Penrith  
Gilwilly Industrial Estate  
Penrith  
Cumbria CA11 9BN  
+44 1768 868 995

ALTO France S.A. Strasbourg  
B.P. 44, 4 Place d'Ostwald  
F-67036 Strasbourg  
Cedex 2  
+33 3 8828 8400

ALTO Nederland B.V. Vianen  
Stuurtweg 4C  
NL-4131 NJ Vianen  
+31 347 324000

ALTO Sverige AB, Molndal (Sweden)  
Aminogatan 18  
Box 4029  
S-431 04 Molndal  
+46 31 706 73 00

ALTO Norge A/S, Oslo (Norway)  
Bjornerudveien 24  
N-1266  
+47 2275 1770

## **CLARKE TECHNOLOGY LIMITED WARRANTY**

This Clarke Industrial/Commercial Product is warranted to be free from defects in materials and workmanship under normal use and service for a period of one year from the date of purchase, when operated and maintained in accordance with Clarke's Maintenance and Operations instructions.

This warranty is extended only to the original purchaser for use of the product. It does not cover normal wear parts such as electrical cable, rubber parts, hoses and motor brushes.

If a difficulty develops with the product, you should:

- a) Contact the nearest authorized Clarke repair location or contact the ALTO U.S. Service Operations Department, 2100 Highway 265, Springdale Arkansas 72764, for the nearest authorized Clarke repair location. Only these locations are authorized to make repairs to the product under this warranty.
- b) Return the product to the nearest Clarke repair location. Transportation charges to and from the repair location must be prepaid by the purchaser.
- c) Clarke will repair the product and/or replace any defective parts without charge within a reasonable time after receipt of the product.

Clarke's liability under this warranty is limited to repair of the product and/or replacement of parts and is given to purchaser in lieu of all other remedies, including INCIDENTAL AND CONSEQUENTIAL DAMAGES.

THERE ARE NO EXPRESS WARRANTIES OTHER THAN THOSE SPECIFIED HEREIN. THERE ARE NO WARRANTIES WHICH EXTEND BEYOND THE DESCRIPTION OF THE FACE HEREOF. NO WARRANTIES, INCLUDING BUT NOT LIMITED TO WARRANTY OF MERCHANTABILITY, SHALL BE IMPLIED. A warranty registration card is provided with your Clarke product. Return the card to assist Clarke in providing the performance you expect from your new floor machine. ALTO U.S. Inc., 2100 Highway 265, Springdale, Arkansas 72764.

**CLARKE TECHNOLOGY reserves the right to make changes or improvements to its machine without notice.  
Always use genuine Clarke Parts for repair.**



**CLARKE TECHNOLOGY  
2100 Highway 265  
Springdale, Arkansas, 72764**