



Electronic Service Manuals

This electronic document is provided as a service to our customers. We do not create the contents of the information contained in this document. Should you have detailed questions pertaining to the information contained in this document, you may contact Michco, or the manufacturer which provided the original information in this electronic deliverable. Michco's only part in this electronic deliverable was the electronic assembly process. By providing this manual on line we are not guaranteeing parts availability.

You may contact Michco through the following methods:

Phone (517) 484-9312 or (800) 331-3339

2011 N. High St. -- Lansing, Michigan -- 48906

Fax: (517) 484-9836

Email: CustServe@Michco.com

Web site: www.Michco.Com

Parts Web site: www.FloorMachineParts.Com

Order Parts on Line at:

www.FloorMachineParts.Com

Directly to Parts & Service:

By Email: **Shop@Michco.com**

By Fax: (517) 702-2041

By Voice: Use numbers above.

Serving the Cleaning Industry Since 1922

Notice: All copyrighted material remains property of original owners, all trademarks are property of respective owners. Manuals are subject to Manufacturer's reproduction limitations. Originals or reproductions were provided by manufacturers through a request. We make no warranty as to the correctness of information provided in this document and you assume all risk. By placing these manuals on line we are not declaring our corporation to be an manufacturer authorized dealer or provider, please check our web site for authorized manufacturers we represent.



PACIFIC



The contents of this manual are based on the latest product information available at the time of publication. Pacific reserves the right to make changes or improvements to its machines without notice.

Carefully inspect all components to ensure that there is no concealed freight damage. If such damage is discovered, file a "CONCEALED DAMAGE REPORT" immediately with the delivering carrier.

FOR YOUR CONVENIENCE, RECORD THE FOLLOWING IMPORTANT INFORMATION:

For new manuals write to:

Pacific
2259 S. Sheridan
Muskegon, MI 49442-6252

SERIAL NUMBER

DATE PURCHASED

or download the most recent version of the manuals from our website:

www.pacificfloorcare.com









PACIFIC SAFETY INSTRUCTIONS

- 1) You must have training in the operation of the machine before using it. **READ THE INSTRUCTION BOOK.** If you do not understand any instruction, ask your supervisor.
- 2) Make sure all labels, decals, warnings, cautions and instructions are fastened to the machine.
- 3) Read the labels carefully on the machine. Do not cover them for any reason and replace them if damaged.
- 4) Do not operate this machine unless it is completely assembled and inspect the machine carefully before operation.
- 5) Pay close attention to other people and especially children while operating this machine.
- 6) Be a careful driver and do not strike shelving or scaffolding, especially where there is a danger of falling objects.
- 7) Machines can cause an explosion when operated near flammable materials and vapors. Do not use this machine with or near fuels, grain dust, solvents, thinners, or other flammable materials.
- 8) In case of fire, use a powder extinguisher. Do not use water.
- 9) Do not use this machine as a means of transport.
- 10) Do not use acid solutions that could damage the machine.
- 11) Adjust your speed to the conditions of the floor.
- 12) Do not turn the machine on an incline. Do not stop and leave the machine on a ramp or incline.
- 13) During any maintenance operation disconnect the power supply from the machine.
- 14) Lead acid batteries generate gases that can cause an explosion. Read the instruction manual supplied with the battery charger. Keep sparks and flames away from batteries. **NO SMOKING.** Charge the batteries only in an area with good ventilation.
- 15) Do not use a charger if the power cord is damaged or if charger is not rated for the machine.
- 16) Always wear eye protection and protective clothing when working near batteries. Remove all jewelry. Do not put tools or other metal across the battery terminals, or on the top of the batteries.
- 17) Maintenance and repairs must be performed by authorized Service Centers only.
- 18) Keep the electrical parts of the machine dry. Do not wash the machine with direct water jets or high pressure, or with corrosive material. For storage, keep the machine in a dry location.
- 19) Water solutions or cleaning materials used with this type of machine can leave wet areas on the floor surface. These areas can cause a dangerous condition for the operator or other persons. Always put **CAUTION** signs near the area you are cleaning.
- 20) Do not reach under shrouds with fingers, hands, or toes when machine is running.



PACIFIC

SYMBOLS USED ON THE AUTOMATIC SCRUBBER

	Water Valve Indicator
	Brush Drive Motor Control Switch
	Vacuum Motor Control Switch
	Battery Charge Indicator
	Main Machine Power Key Switch
	Squeegee Lift Control Lever
	Solution Flow Rate Adjusting Lever



PACIFIC MACHINE PREPARATION

1) UNPACKING THE MACHINE

- a) Take off the outer packaging.
- b) The machine is fastened to the pallet with wooden wedges that block the wheels. Remove tie down straps.
- c) Using a ramp, pull the machine off the pallet.



Remove

2) BATTERY INSTALLATION

- a) Remove the squeegee hose from the recovery tank.
- b) Remove the vacuum cover by rotating it counterclockwise.
- c) Remove recovery tank by lifting tank by lift chain at the back of the tank and the drain hose at the front of the tank.

Remove

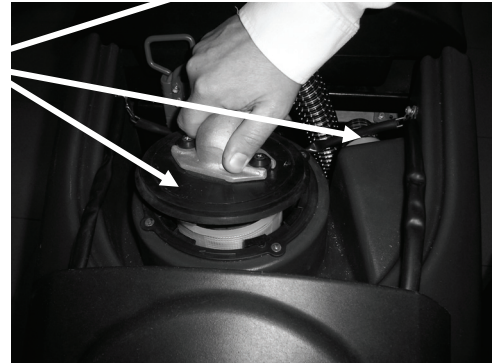

Lift Chain

Drain Hose Lift Point





PACIFIC MACHINE PREPARATION

BATTERY INSTALLATION (Cont.)

- d) Place the batteries in the battery compartment.
- e) Connect the battery connector to the machine connector
- f) Replace the recovery tank and reassemble the vacuum cover and squeegee hose.

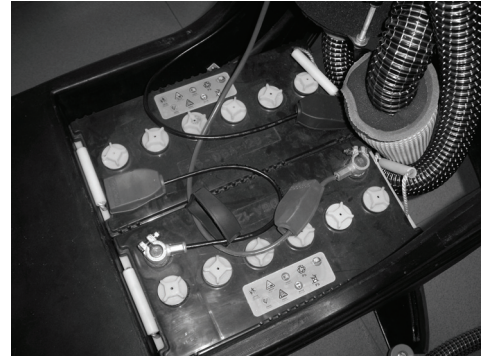

Machine Connector

Battery Connector

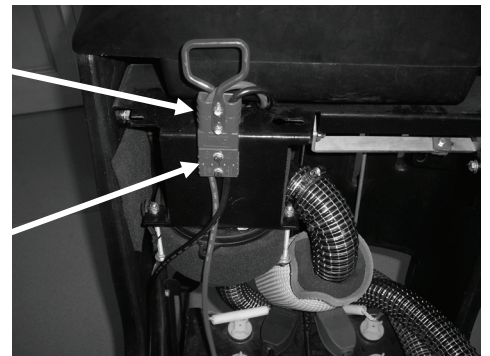

3) BATTERY CHARGE LEVEL INDICATOR

The battery indicator is digital with 4 display levels and a flashing one. The numbers, which appear on the display, show the approximate charge level. 4 represents a full charge and 0 represents discharged and the batteries must be recharged.

NOTE: The brush motor automatically switches off after the battery indicator light begins to flash. You will be able run the vacuum motor and finish drying any wet areas.

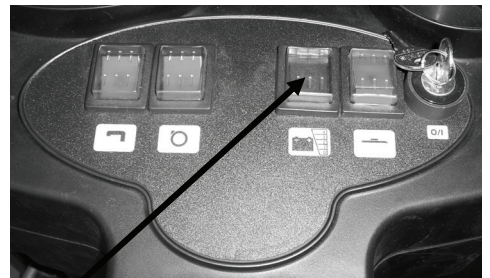

Battery Charge
Indicator



PACIFIC MACHINE PREPARATION

4) SQUEEGEE ASSEMBLY INSTALLATION

The squeegee is assembled to the machine by lifting the locking latches and sliding the squeegee assembly onto the 2 posts at the rear of the squeegee swing arm. Push on the locking latches down. Lower the squeegee and install vacuum hose over vacuum outlet on squeegee assembly. The hose should be located to the rear of the lifting cable.

Vacuum
Outlet

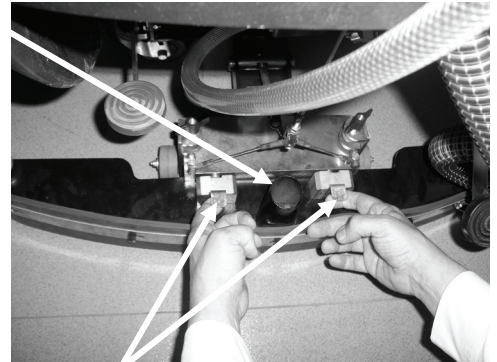

Locking Latches

5) ADJUSTING SQUEEGEE HEIGHT

The height from floor to squeegee should be adjusted based on blade wear. Rotate the adjusting knobs counter-clockwise to lower squeegee and clockwise to lift it.

NOTE: Rotate the right and left adjusting knobs until the squeegee is positioned parallel to the floor.

Height
Adjusting
Knobs

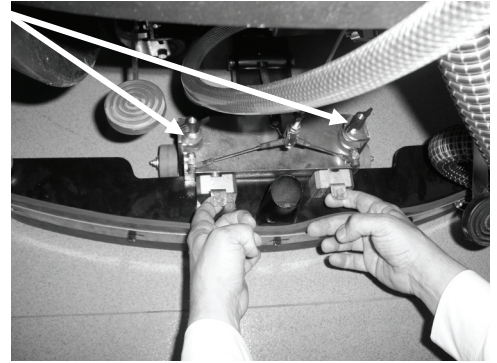

6) ADJUSTING SQUEEGEE INCLINATION

During operation the rear squeegee blade is most efficient when bent backwards roughly $3/16^{\text{th}}$ to $5/16^{\text{th}}$ of an inch along its entire length. To increase the blade bending in the center of the squeegee, tilt the squeegee body backward by turning the adjuster knob counter-clockwise. Conversely, turn the adjuster knob clockwise to increase the bending at the outside edges of squeegee blade.

Inclination
Adjusting
Knob

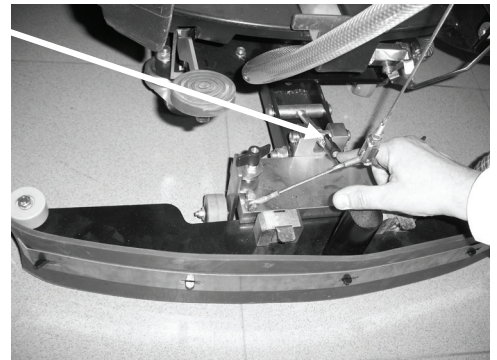



PACIFIC MACHINE PREPARATION

7) RECOVERY TANK

Open the lid and confirm the following connections are secure:

- The vacuum cover is securely attached. Align the notches and rotate the cover clockwise to close. The vacuum hose must also be attached.
- Confirm that the squeegee hose is properly connected.
- Confirm that the drain hose plug, which is located at the front of the machine, is closed.

Vacuum
Cover

Squeegee
Hose

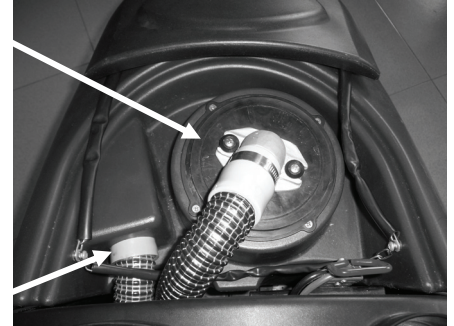

8) SOLUTION WATER

Fill the solution tank with clean water at a temperature not higher than 50°C / 122°F. Add the proper concentration of liquid detergent by following the manufacturer instructions. Excess foam in the recovery tank can damage the vacuum motor, so use only the minimum amount of detergent necessary. Reassemble the cover.



WARNING! Always use low foaming detergent. Adding antifoam liquid into the recovery tank before cleaning will also help prevent foaming.

NEVER USE ACID, BLEACH or AMMONIA

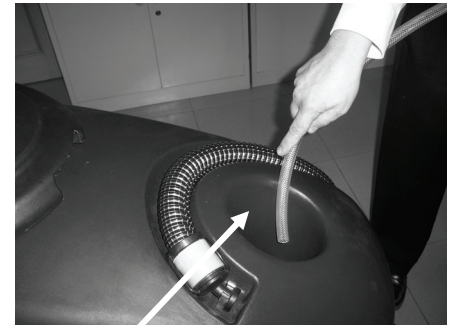

Solution Tank
Fill Opening

9) BRUSH INSTALLATION

- Lift the brush base by depressing the foot level at the rear of the machine.
- Place the brushes under the base. Align the brush lugs with the holes in the brush plate. Insert the brushes into the plate and turn each brush so the lugs are pushed toward their retaining springs, until locked. The photo shows the directions to rotate the brushes to lock them into operating position.

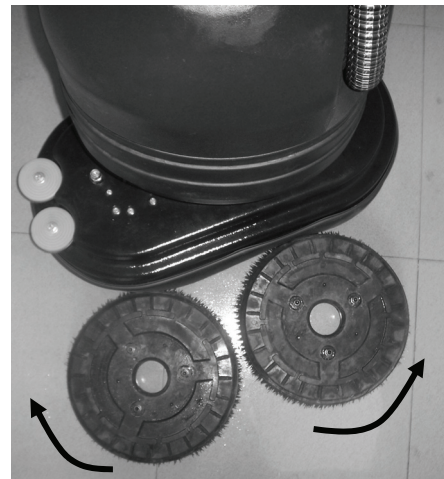

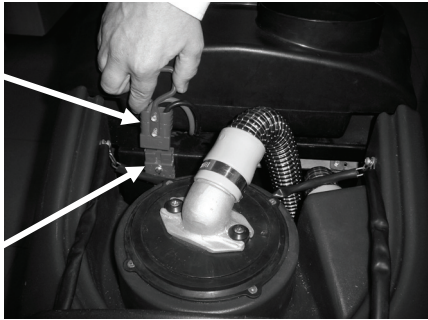
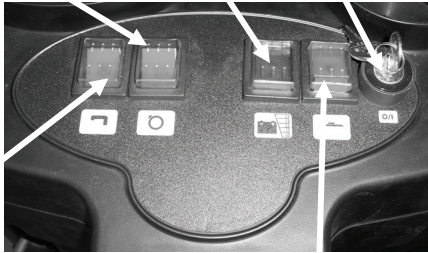
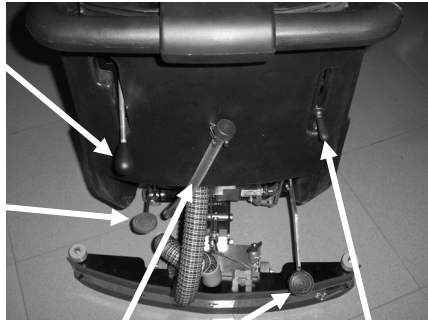

PACIFIC MACHINE OPERATION

<p>1) Connect machine connector to the battery connector.</p>	<div style="display: flex; flex-direction: column; align-items: flex-start;"> <div style="display: flex; align-items: center; margin-bottom: 10px;"> Machine Connector </div> <div style="display: flex; align-items: center;"> Battery Connector </div>  </div>
<p>2) Turn on the main power key switch. Battery charge indicator will illuminate indicating the charge level of the batteries. If the indicator is flashing the batteries need to be charged.</p> <p>3) Turn on the brush motor switch. Please note that the scrubbing brush will not rotate until the hand switch lever is engaged.</p> <p>4) Turn on the water solenoid valve switch.</p> <p>5) Turn on the vacuum motor switch.</p>	<div style="display: flex; flex-direction: column; align-items: flex-start;"> <div style="display: flex; justify-content: space-around; margin-bottom: 10px;"> Vacuum Motor Switch Battery Charge Indicator Main Power Key Switch </div> <div style="display: flex; align-items: center; margin-bottom: 10px;"> Water Solenoid Switch </div> <div style="display: flex; align-items: center;">  </div> <div style="display: flex; justify-content: flex-end; margin-top: 10px;"> Brush Motor Switch </div> </div>
<p>6) Adjust the flow rate of the cleaning solution with lever. Moving the solution flow control lever downward increase the flow rate and raising the lever decreases the flow rate. There should be enough solution to wet the floor uniformly, but not so much that the water gets past the splash guard. Remember that the correct solution quantity depends on the type of floor, the dirt level and the scrubbing speed.</p> <p>7) Release parking brake by raising parking brake lever.</p> <p>8) Release and raise the brush base lift lever to lower the brush base.</p> <p>9) Lower the squeegee using the squeegee lift lever.</p>	<div style="display: flex; flex-direction: column; align-items: flex-start;"> <div style="display: flex; align-items: center; margin-bottom: 10px;"> Squeegee Lift Lever </div> <div style="display: flex; align-items: center; margin-bottom: 10px;"> Parking Brake Lever </div>  <div style="display: flex; justify-content: space-around; margin-top: 10px;"> Solution Tank Drain Hose Brush Base Lift Lever Solution Flow Control Lever </div> </div>



PACIFIC MACHINE OPERATION

10) SCRUBBING

This machine is equipped with brush assist propulsion. Depress the handle switch lever. The scrub brush will begin to rotate and solution will begin to flow. During the first few yards of operation, check that the quantity of the cleaning solution is sufficient to wet the floor and that the squeegee dries the floor surface.



WARNING! Always lift the squeegee when moving backwards.

Handle
Switch
Lever

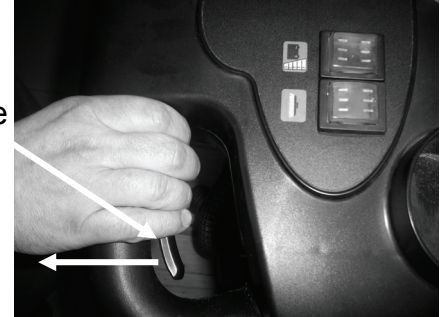

11) OVER FILL PROTECTION

The machine is equipped with a float that stops the vacuum exhaust air flow when the recovery tank is full. Vacuum motor does not stop operating but the vacuum exhaust air flow rate is greatly reduced. When this occurs, empty the recovery tank by removing the drain plug on the drain hose and then empty the recovery tank.



WARNING! Use gloves for protection from contact with dangerous solutions.

Float

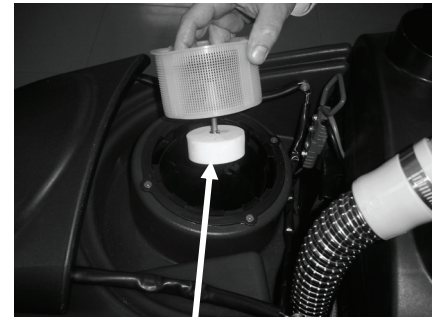

Drain Plug





PACIFIC

UPON COMPLETION OF MACHINE USE

After finishing your work and before any type of maintenance is done, it is necessary to do the following:

- 1) Close the water valve by raising the solution flow control lever.
- 2) Raise the brush base by stepping down locking the brush base lift lever. To lock the lever move your foot to the right while the lever is pressed down.
- 3) Lock parking brake by stepping down on parking brake lever. To lock the lever move your foot to the right while the lever is pressed down.
- 4) Lift the squeegee by raising the squeegee lift lever and locking it by moving the lever to the left.



WARNING! The squeegee blades can be damaged if the squeegee is not raised during storage or transport.

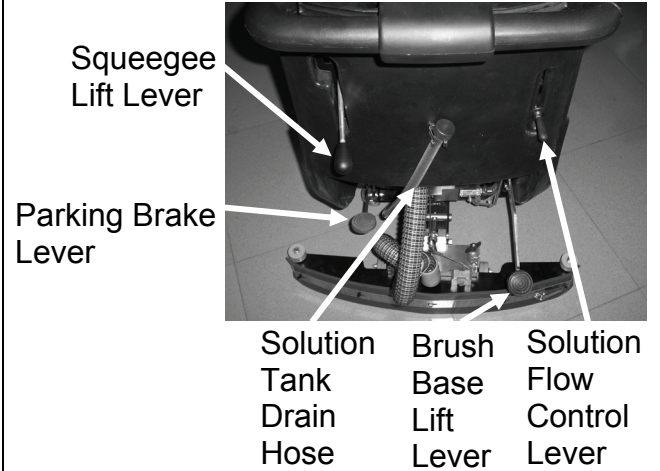

- 5) Switch off main power key switch.
- 6) Switch off the water solenoid valve switch.
- 7) Switch off the brush motor switch.
- 8) Switch off the vacuum motor switch.
- 9) Transport the machine to the location where the recovery tank should be emptied.

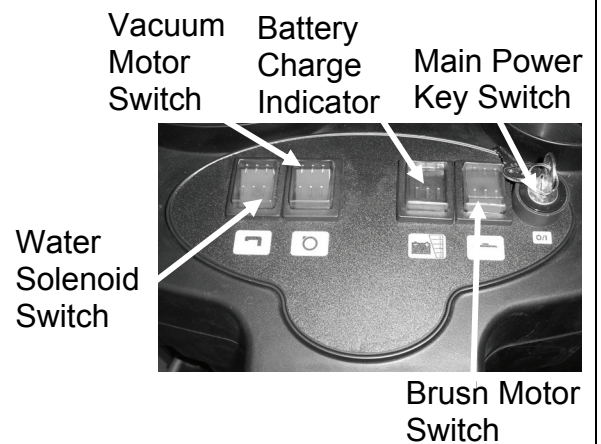

- 10) Remove the drain hose at the front of the recovery tank.
- 11) Remove the drain plug and empty the recovery tank.



WARNING! Use gloves for protection from contact with dangerous solutions.

- 12) Remove the brush or pad driver and clean them with clear water.

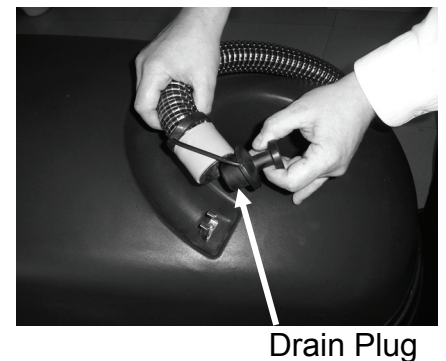



PACIFIC DAILY MACHINE MAINTENANCE

CLEANING THE RECOVERY TANK

- 1) Empty the recovery tank by removing the drain plug from the drain hose.



WARNING: Use gloves for protection from contact with dangerous solution.



Drain Plug

- 2) Lift the cover of the recovery tank.
- 3) Take off the vacuum cover by rotating it counter clockwise.
- 4) Remove the filter and its housing.
- 5) Rinse the tank with clean water.

Vacuum
Cover

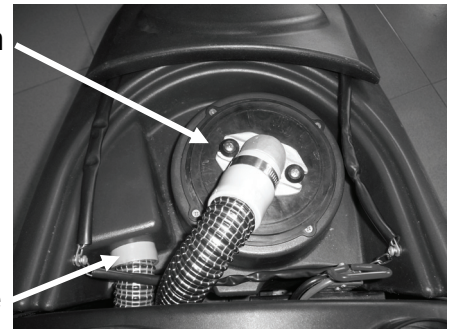

Squeegee
Hose

CLEANING THE VACUUM FILTER

- 6) Lift the cover.
- 7) Take off the vacuum cover by rotating it counter clockwise.
- 8) Remove the filter and its housing.
- 9) Use clear water to clean the walls and the bottom of the filter.
- 10) Remove the filter and its housing.
- 11) Wash all components thoroughly.
- 12) Reassemble repeating the above operations in reverse.





PACIFIC DAILY MACHINE MAINTENANCE

CLEANING THE SQUEEGEE

To obtain the best drying results, keep the squeegee clean. To clean the squeegee it is necessary to:

- 13) Remove the vacuum hose from the squeegee.
- 14) Lift locking latches. Remove the squeegee assembly by pulling rearward.
- 15) Clean the inside of the squeegee thoroughly.
- 16) Clean the squeegee blades thoroughly.
- 17) Reassemble.

Vacuum
Outlet

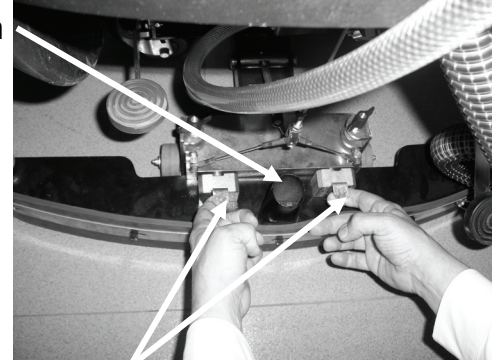

Locking Latches

REPLACING THE SQUEEGEE BLADES

Check the squeegee blades for wear and if necessary, change them. To replace the squeegee blades:

- 18) Remove the squeegee vacuum hose from its port.
- 19) Lift locking latches and pull squeegee assembly rearward.
- 20) Release the band clamps by lifting the band clamp latch.
- 21) Remove squeegee blades.
- 22) Rotate or replace the blades. Please note that the squeegee has 4 useable edges so you may be able to rotate squeegee blades.
- 23) To reassemble the squeegee, repeat the above operations in reverse.



Band
Clamp
Latch



Squeegee
Blade



Band
Clamp

Band
Clamp
Latch



Squeegee
Blade



Band
Clamp



PACIFIC DAILY MACHINE MAINTENANCE

BRUSH / PAD DRIVER REMOVAL

- 24) Lift the brush base by depressing the foot level at the rear of the machine.
- 25) The photo shows the directions to rotate the brushes to unlock them from the auto scrubber. Clean the brushes with clear water.

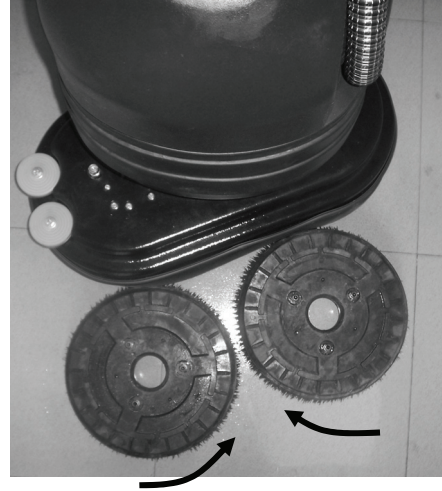



PACIFIC

WEEKLY MACHINE MAINTENANCE

CLEANING THE SQUEEGEE HOSE

To obtain the best drying results, keep the squeegee hose clean. To clean the squeegee hose it is necessary to:

- 1) Take off the vacuum hose from its vacuum port on the squeegee.
- 2) Remove the other end of the vacuum hose from the recovery tank.
- 3) Wash the inner part of the hose with clean water.
- 4) Reassemble.



WARNING: Do not wash the hose that goes from the vacuum motor to the vacuum cover.

Do Not Wash Vacuum Cover Hose

Wash Squeegee Hose

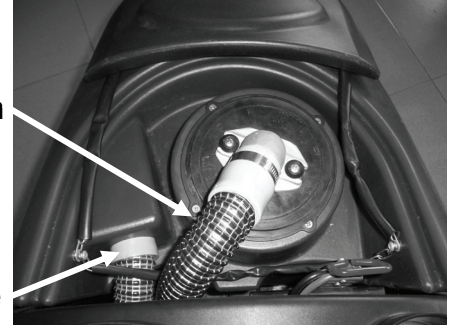

SOLUTION TANK CLEANING

- 5) Remove the fill cap from the solution tank.
- 6) Rinse with clear water.
- 7) Remove the solution tank drain hose and cap at rear of machine and empty the solution tank.



WARNING: Use gloves for protection from contact with dangerous solution.



Solution Tank Fill Opening

IN-LINE FILTER CLEANING

- 8) Drain solution tank.
- 9) Turn off solenoid valve.
- 10) Loosen set screw on in-line filter but do not remove.
- 11) Pull rear hose rearward and separate in-line filter into 2 pieces.
- 12) Remove the filter element and clean with clear water.
- 13) Reassemble.



WARNING: Use gloves for protection from contact with dangerous solution.

In-Line Filter

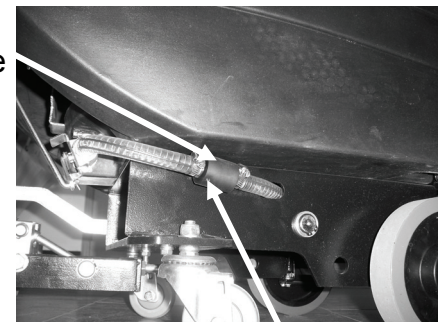

Set Screw

Filter Element

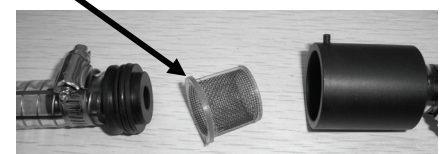



PACIFIC WATER SOLENOID MAINTENANCE

In the event that the water solenoid begins to leak when turned off debris must be cleared at the valve seat. To gain access the water solenoid the scrub deck must be disassembled from the lifting arms. Remove the 4 bolts shown in the photo to release the scrub deck.

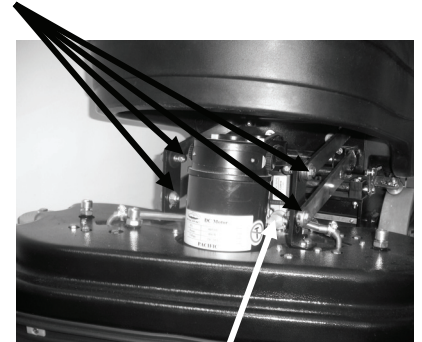

Water
Solenoid



PACIFIC TROUBLE SHOOTING GUIDE

1) INSUFFICIENT WATER TO THE BRUSHES

- a) Make sure the solution flow control valve is open.
- b) Confirm that there is water in the solution tank.
- c) Make sure solution dispensing tubes are not clogged or obstructed.

Solution
Flow
Control
Lever

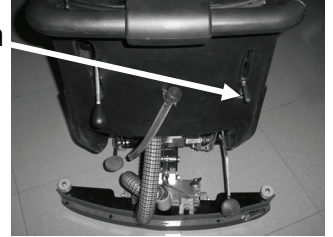

2) THE MACHINE DOES NOT CLEAN SATISFACTORILY

- a) Check the condition of the brush or pad and replace them if necessary.
- b) The brush should be replaced when the bristles reach a length of 5/8 inches (15mm).

3) THE SQUEEGEE DOES NOT DRY THE FLOOR WELL

- a) Check that the squeegee blades are clean.
- b) Adjust the inclination of the squeegee.
- c) Confirm the vacuum hose is correctly fitted into its port in the recovery tank and free from obstructions.
- d) Replace the squeegee blades if worn.
- e) Check that the vacuum motor switch is on.
- f) Check the squeegee height adjustment (see "MACHINE PREPARATION" section).

4) EXCESSIVE FOAM PRODUCTION

- a) Check that a low foaming detergent has been used. If required, add a small quantity of defoamer liquid to the recovery tank. More foam is generated when a floor is lightly soiled. Use less detergent if this is the case.



Brush Deck Assembly

Drawing 1

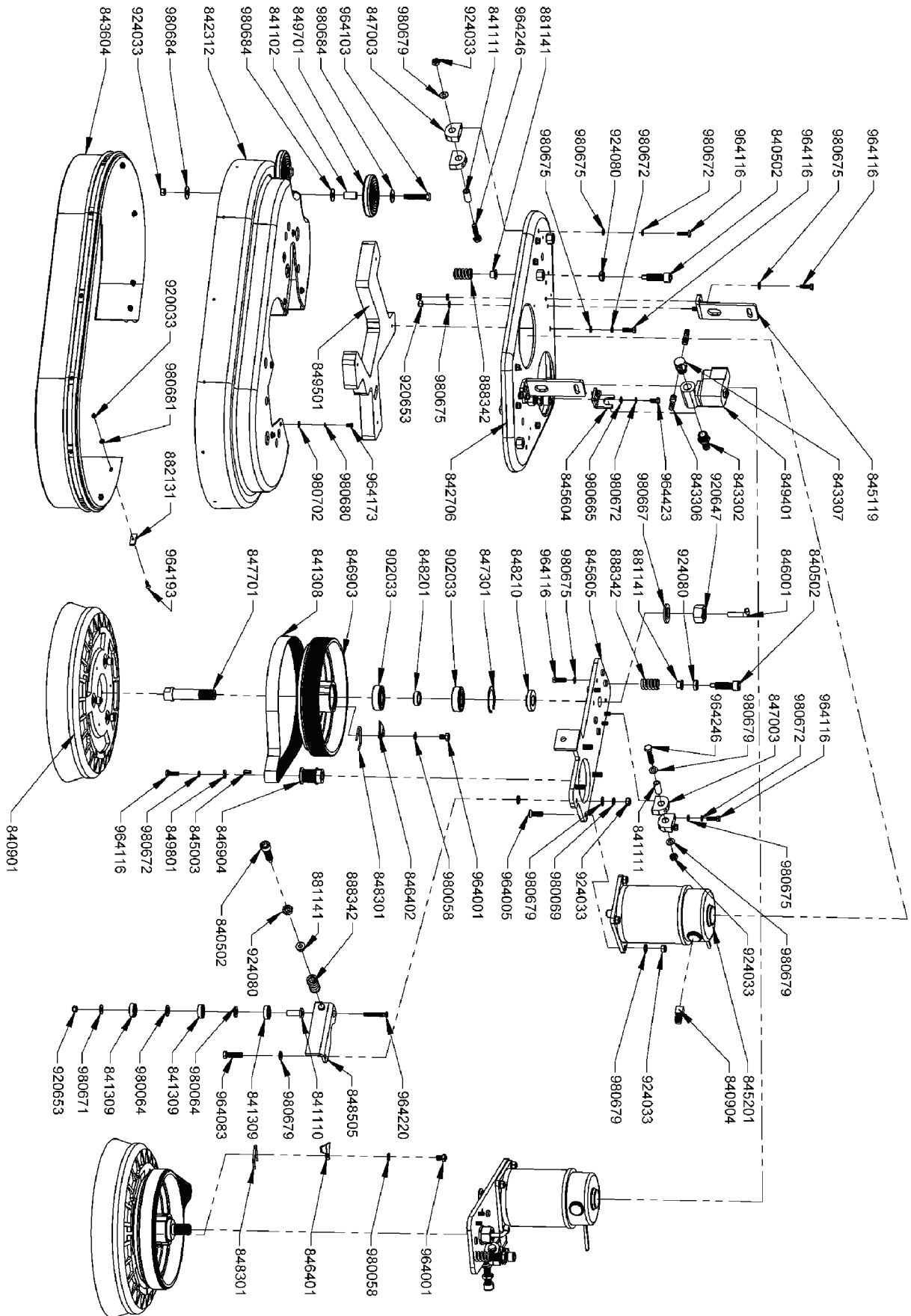



PACIFIC

Drawing 1

PART NUMBER	DESCRIPTION & SPECIFICATION	QTY	NOTE
840502	Adjuster Bolt	6	
840901	Brush	2	Optional
840904	Carbon Brush	4	
841102	Wheel Bushing	2	
841110	Bushing	2	
841111	Bushing	4	
841308	Brush Drive Belt	2	
841309	Bearing	6	
842312	Base Cover	1	
842706	Brush Deck	1	
843302	Fitting Barbed	1	
843306	Fitting Barbed	2	
843307	Fitting	1	
843604	Z26 Splash Guard - Blue	1	
845003	Key - Motor Shaft	2	
845119	Brush Base Dual Lift Link	2	
845201	Brush Motor Asm	2	
845604	Solenoid Valve Mount	1	
845605	Motor Mount Weldment	2	
846001	Pipe	2	
846401	Left Spring Retaining Plate	1	
846402	Right Spring Retaining Plate	1	
846903	Brush Clutch Pulley	2	
846904	Pulley	2	
847003	Brush Deck - Pivot Block	8	
847301	Retaining Ring 50 mm	2	
847701	Brush Pulley Shaft	2	
848201	Bearing Spacer	2	
848210	Spacer	2	
848301	Brush Retaining Spring	2	
848505	Belt Tensioner Support Arm Weldment	2	
849401	Solenoid Valve	1	
849501	Brush Deck Weight	1	
849701	Wheel	2	
849801	Thrust Washer	2	
881141	Bushing	6	
882131	Clip Guard	12	
888342	Spring	6	
902033	Bearing	4	
920033	M4 Hexagon Lock Nut	12	
920647	Hex Nut M20 Zinc	2	
920653	M6 Nyloc Hex Nut Zinc	6	
924033	NyLoc Hex Nut M8 Zinc	16	
924080	Jam Nut M12 Zinc	6	
964001	Hex Bolt M8x12	2	
964005	Flat Head Soc Hex Screw Full Thd M8X25	8	
964083	Hex Bolt M8X30 Zinc	2	
964103	Hex Bolt-Full M8x45 Zinc	2	
964116	M8 Washer Flat Zinc	26	
964173	Hex Bolt Full Thread M4x8 Zinc	6	
964193	Oval HD Screw M4x16 Zinc	12	
964220	M6x45 Flat Hd Phil Zinc	2	
964246	Hex Bolt M8x35 Zinc	4	
964423	Hex Bolt M6X12 Zinc	2	
980058	Washer Star Lock M8	2	
980064	M10 Washer Flat Zinc	4	
980069	Lock Washer M8 Zinc	2	
980665	M6 Flat Washer Zinc	2	
980667	Washer M20x39 Flat Zinc	2	
980671	M6 Washer Flat XL Zinc	2	
980672	M6 Lock Washer Zinc	16	
980675	M6 Flat Washer Stainless	28	
980679	M8 Washer Flat Zinc	22	
980680	Lock Washer M4 Zinc	6	
980681	Washer M4 Flat Zinc	12	
980684	M8 Washers Flat L Zinc	6	
980702	M4 Large Flat Washer Zinc	6	



PACIFIC

Drawing 2

PART NUMBER	DESCRIPTION & SPECIFICATION	QTY	NOTE
840308	Brake Lever Arm Weldment	1	ZINC
840310	Brush Deck Idle Arm Weldment	1	ZINC
840311	Brush Desk Lift Arm Weldment ASM	1	ZINC
841108	Bushing	2	
841112	Bushing	2	
842003	Hose Clamp	2	SS
842008	Z20-Z26 Clamp Bar	1	
842306	Pedal Cover	1	
842311	Pedal Cover - Brake	1	
842701	Metal Disc	2	ZINC
843314	In Line Filter Outer Housing	1	
843315	In Line Filter Inner Housing	1	
843316	In Line Filter Element	1	
843603	Z20-Z26 Splash Guard	1	
843801	Grommet	1	
845117	Brake Lever Arm Weldment	1	ZINC
845118	Brake Latch	1	ZINC
845801	O-Ring 21.2x2.65	1	
845902	Brake Pad	2	ZINC
846404	Axle Retaining Plate Weldment	1	EPOXY PAINT
846405	Axle Retaining Plate Weldment	1	EPOXY PAINT
847001	Brush Lift - Pivot Block	8	
847002	Brush Lift - Pivot Block	4	
847302	Retaining Ring 20mm x 1.2mm THK	1	
847407	Brake Screw Rod	1	ZINC
847705	Wheel Shaft	1	ZINC
848206	Wheel Spacer	2	ZINC
848208	Pivot Block Spacer	2	
848302	SPRING	2	ZINC
848309	Brake Return Spring	1	ZINC
849005	Tubing	1	
849006	Tubing	1	
849703	Castor	2	
849704	Main Wheel	2	
920648	M12 Nyloc Hex Nut Zinc	3	
920649	Hex Nut M8 Zinc	6	
920653	M6 Nyloc Hex Nut Zinc	14	
924032	M5 Nyloc Hex Nut Zinc	8	
924033	NyLoc Hex Nut M8 Zinc	8	
924063	Hex Nut M6 Zinc	2	ZINC
964007	Hex Bolt M8x40 Zinc	2	
964083	Hex Bolt M8X30 Zinc	2	
964116	Hex Bolt M6x20 Zinc	2	
964182	Screw M4x10 Pan Head Zinc	4	
964209	Hex Bolt M6x16 Zinc	4	
964225	Hex Bolt M5X20 Zinc	8	
964230	Hex Bolt M12x65 Zinc	1	
964400	Flat Head Soc Hex Screw M6x16 Zinc	2	
964428	Hex Bolt M6x60 Zinc	4	
964429	Hex Bolt M6x50 Zinc	6	
964437	Screw - SHCS M8x40 Zinc	2	
964442	Slotted Set Screw Cone Point M3x6	1	
980043	Washer Flat M12	5	
980501	M6x22 OD Washer Flat Zinc	2	
980665	M6 Flat Washer Zinc	24	
980670	M6 External Lock Washer Zinc	2	
980671	M6 Washer Flat L Zinc	2	
980672	M6 Lock Washer Zinc	2	
980676	M8 Washer - Plastic	4	
980679	M8 Washer Flat Zinc	8	
980684	M8 Washers Flat L Zinc	2	
980684	M8 Washers Flat L Zinc	6	
980685	M5 Washer Flat Zinc	16	
74610004	Fork	2	
74620005	Pin	2	



PACIFIC

Drawing 3

PART NUMBER	DESCRIPTION & SPECIFICATION	QTY	NOTE
840304	Squeegee Link Arm Weldment	1	
840501	Squeegee Adjuster Bolt Rod	1	
841103	Wheel Bushing	2	
842405	Squeegee Lift Cable	2	
842407	Squeegee Lift Cable	1	
845001	Knob Handle	3	
845601	Squeegee Mount Base	1	
845602	Squeegee Mount Base Pivot	1	
846701	Squeegee Attachment Pin	2	
847302	Retaining Ring 20mm x 1.2mm THK	2	
847303	Retaining Ring 15mm x 1.0mm THK	2	
847305	Squeegee Lift Ring	2	
847403	Rod End Male M12 Zinc	1	
847702	Squeegee Adjuster Front Shaft	1	
847703	Squeegee Adjuster Rear Shaft	1	
848302	SPRING	1	
848303	Spring - Squeegee Adjust	2	
848401	Squeegee Wheel Adjusting Stud	2	
848501	Wheel Strut Weldment	2	
849702	Wheel Tread	2	
887341	E-Ring 9 mm ID	2	
920615	Hex Nut M5 Zinc	2	
920648	M12 Nyloc Hex Nut Zinc	1	
920649	Hex Nut M8 Zinc	3	
920650	Hex Nut M12 Zinc	1	
920653	M6 Nyloc Hex Nut Zinc	4	
924033	NyLoc Hex Nut M8 Zinc	1	
964005	Flat Head Soc Hex Screw Full Thd M8X25	3	
964116	Hex Bolt M6x20 Zinc	2	
964220	M6x45 Flat Hd Phil Zinc	2	
964243	Hex Bolt M12x100 Lg Zinc	1	
980043	Washer Flat M12	4	
980671	M6 Washer Flat XL Zinc	2	
980679	M8 Washer Flat Zinc	4	
980685	M5 Washer Flat Zinc	2	



PACIFIC

Drawing 4			
PART NUMBER	DESCRIPTION & SPECIFICATION	QTY	NOTE
840703	Squeegee Blade Front	1	
840704	Squeegee Blade Rear	1	
841304	Squeegee Attachment Block	2	
842012	Band Clamp-Rear	1	
842013	Band Clamp-Front	1	
843205	Squeegee Frame Weldment	1	
843317	Filler - Z26 Squeegee	2	
845104	Latch ASM	2	
845105	Squeegee Attachment Block Latch	2	
881145	Wheel Bushing	2	
889742	Wheel 45 Dia	2	
920649	Hex Nut M8 Zinc	2	
924033	NyLoc Hex Nut M8 Zinc	2	
925009	Roll Pin M5.5x12 SS	1	
930012	REVIT M4x8 Lg Oval Head Semi-Tubular	4	
964004	Hex Set Screw M6X8	2	
964103	Hex Bolt-Full M8x45 Zinc	2	
964209	Hex Bolt M6x16 Zinc	2	
964232	Hex Bolt M6x25 Zinc	4	
980665	M6 Flat Washer Zinc	6	
980672	M6 Lock Washer Zinc	4	
980679	M8 Washer Flat Zinc	4	
980681	Washer M4 Flat Zinc	4	
980684	M8 Washers Flat L Zinc	2	



PACIFIC

Drawing 5			
PART NUMBER	DESCRIPTION & SPECIFICATION	QTY	NOTE
841300	Rear Battery Bracket	1	
841303	Side Battery Bracket	1	
842003	Hose Clamp	2	
842705	Sound Deadener	1	
843308	Fitting Barbed	1	
843309	Fitting Barbed	1	
843310	Filter Basket	1	
843401	Battery Plastic Gasket	1	
843402	Side Battery Gasket	1	
843404	Conical Tank Gasket	1	
844702	Fitting	1	
845106	Brush Deck Lift Latch	1	
845111	Z Series Water Control Label	1	
845113	Z Series Squeegee Lift Label	1	
845125	Lever - Valve	1	
846406	Plate Wire Retaining	3	
846603	Water Valve Limit Plate	1	
847406	Connecting Rod	1	
848302	Spring	1	
848603	Z20-Z26 Solution Tank	1	
849008	Drain Tubing - Solution Tank	1	
849402	Valve	1	
882440	Hook	1	
885044	Knob	1	
886852	Cap	1	
920615	Hex Nut M5 Zinc	1	
924051	M5 Retaining Nut	1	
925008	Cotter Pin M2x10	1	
964127	Screw M4X8 Pan Head Zinc	1	
964209	Hex Bolt M6x16 Zinc	2	
964224	M5.5X16 Pan Head Plastite Screw	4	
964228	M3X9.5 Pan Head Plastite Screw	6	
964231	ST4.2X13 Pan HD PL Zinc	2	
964332	Hex Bolt M8x80 Zinc	4	
964398	Hex Bolt-Full THD M6x25 SS	1	
980060	Plastic Washer M5	1	
980504	M6x30 OD Washer Flat Plastic	2	
980665	M6 Flat Washer Zinc	2	
980671	M6 Washer Flat XL Zinc	4	
980672	M6 Lock Washer Zinc	2	
980679	M8 Washer Flat Zinc	1	
980680	Lock Washer M4 Zinc	1	
980682	M3 Washer Flat Zinc	6	
980684	M8 Washers Flat L Zinc	4	
980685	M5 Washer Flat Zinc	2	
980702	M4 Large Flat Washer Zinc	1	



PACIFIC

Drawing 6			
PART NUMBER	DESCRIPTION & SPECIFICATION	QTY	NOTE
505172	Dolphin Dome Label-Large	1	
842007	Hose Clamp	1	
842305	Solution Tank Cover	1	
842308	Z20-Z26 Recovery Tank Cover	1	
842403	Chain	2	
842411	Chain For Lift	1	
843405	Tank Gasket	1	
844101	Z210 Recovery Tank Vacuum Hose	1	
844102	Z210 Squeegee Vacuum Hose	1	
844103	Z20-Z26 Drain Hose	1	
845110	Z Series Recovery Tank Cover Label	1	
845131	Lift Label	1	
846801	Plug - Solution Tank Fill	1	
847304	Ring - Filter Holder	1	
848101	Sleeve	2	
848103	Sleeve For Lift	1	
848604	Z20-Z26 Recovery Tank	1	
849004	Tubing	1	
882440	Hook	1	CHROMATE
882442	Vacuum Outlet Port	1	
883343	Filter Basket	1	
883344	Float	1	
883441	Gasket	1	
883442	M8 Washer Flat Zinc	1	
883446	Gasket	1	
886841	Filter Cover	1	
887440	Float Rod	1	
888551	Splash Protector	1	
924045	M5 Nyloc Hex Nut Stainless	2	
925603	Cotter Pin M2x20	2	
964063	FLHD Screw Ph Drive SS 4.2x13	4	
964105	Oval HD PHL Screw M5x25 SS	2	
964226	Screw M5x8 Pan Head Zinc	4	
964231	ST4.2X13 Pan HD PL Zinc	2	
980060	Plastic Washer M5	2	
980675	M6 Flat Washer Stainless	2	
980677	Washer M5 Flat XL Zinc	4	
980704	M5 Washer Flat SS	2	
S611A	Hose Clamp 45mm	3	



PACIFIC

Drawing 7

Drawing 7			
PART NUMBER	DESCRIPTION & SPECIFICATION	QTY	NOTE
840305	Lever Arm Weldment	1	ZINC
840805	Bracket-Weldment	1	EPOXY PAINT
841104	Bushing	2	BRASS
841305	Lever Bracket	1	ZINC
842014	Hose Clamp 50mm	1	SS
842702	Vacuum Motor Sound Deadener	1	
842703	Vacuum Motor Sound Deadener	1	
842704	Sound Deadener	1	
843801	Grommet	1	
843901	Connector Handle	1	
844104	Vacuum Exhaust Hose	1	
845002	Lever Arm Knob	1	ZINC
845202	24VDC Vacuum Motor - SIX	1	
845603	Muffler	1	
847405	Rod - Connecting	1	ZINC
911441	Connector Male 50A	1	
911442	Connector Female 50A	1	
911531	Hose Clamp	1	
920033	M4 Hexagon Lock Nut	4	ZINC
920653	M6 Nyloc Hex Nut Zinc	6	ZINC
924063	Hex Nut M6 Zinc	4	ZINC
962332	ST M6.3X22 Pan Head Zinc	2	ZINC
964116	Hex Bolt M6x20 Zinc	3	ZINC
964176	Hex Bolt M6X30 Zinc	2	ZINC
964421	Screw M4x25 Pan HD PL Zinc	2	ZINC
964422	Screw M4x20 Pan HD PL Zinc	2	ZINC
964423	Hex Bolt M6X12 Zinc	5	ZINC
980501	M6x22 OD Washer Flat Zinc	2	ZINC
980665	M6 Flat Washer Zinc	18	ZINC
980671	M6 Washer Flat XL Zinc	2	ZINC
980672	M6 Lock Washer Zinc	6	ZINC
980681	Washer M4 Flat Zinc	4	ZINC



Switch Box Assembly

Drawing 8

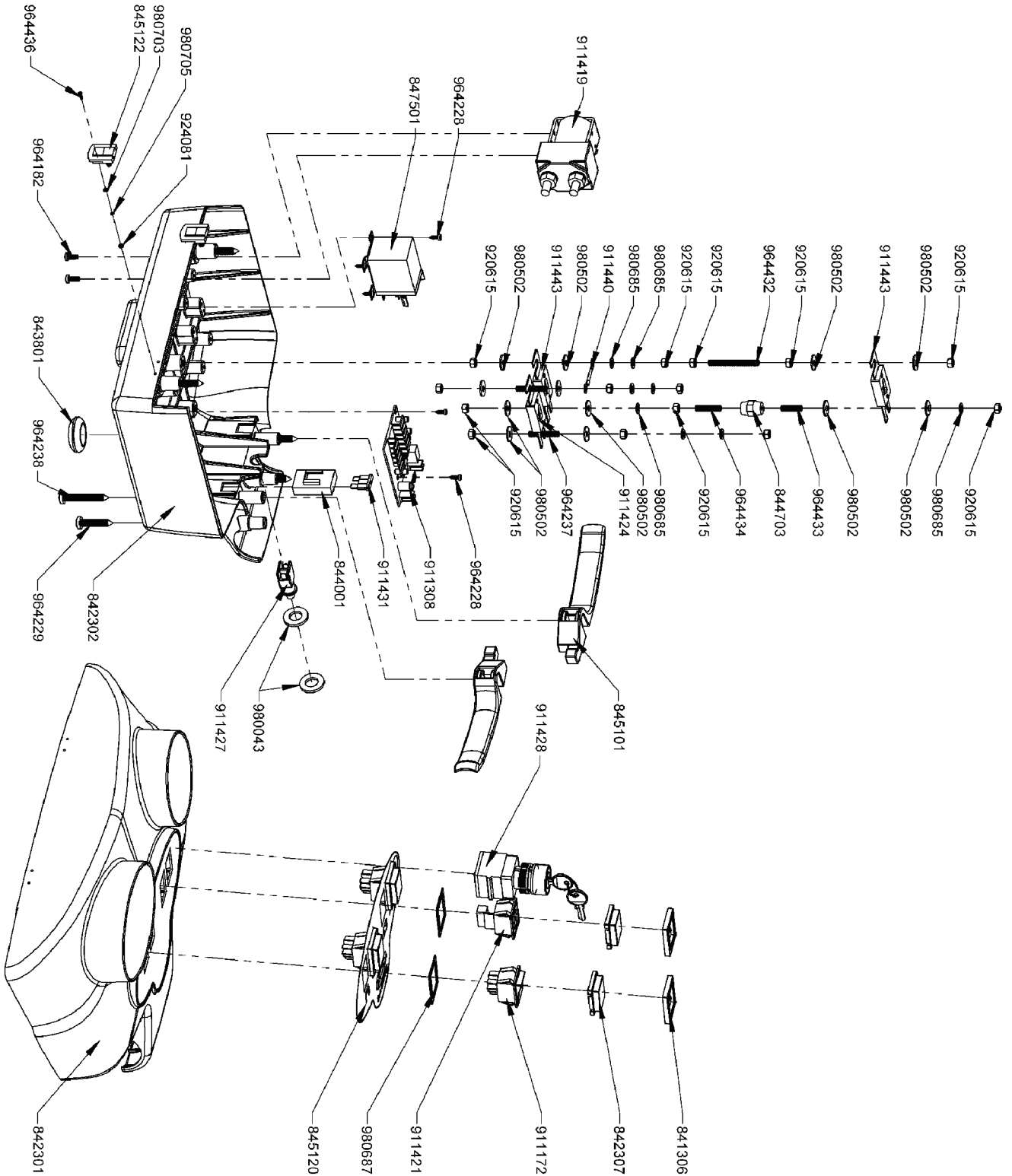



PACIFIC

Drawing 8

Drawing 8			
PART NUMBER	DESCRIPTION & SPECIFICATION	QTY	NOTE
841306	Bezel - Rocker Switch	5	
842302	Cover Lower Switch Box	1	
842307	Cover - Rocker Switch	5	
843801	Grommet	1	
844001	Fuse Holder	1	
844703	Insulator	1	
845101	Scrubber Lever - Switch Box	2	
845120	Z26BA Switch Box Label	1	
845122	Switch Box Latch	2	
847501	Traction & Vacuum Motor Relay	1	
847501	Traction & Vacuum Motor Relay		
911172	Rocker Switch Green	3	
911308	Battery Check Card	1	
911419	Brush Motor Relay	1	
911421	Battery Charge Numeric Indicator	1	
911424	Fuse 30Amp	1	
911427	Trigger Switch	1	
911428	Key Switch	1	
911431	Fuse 3Amp	1	
911440	Jumper Wire	1	
911443	Fuse 50Amp	2	
920615	Hex Nut M5 Zinc	14	
924081	Hex Nut M2 Zinc	8	
964182	Screw M4x10 Pan Head Zinc	2	
964228	M3 x9.5 Pan Head Plastite Screw	6	
964229	M6.0x32 Pan Head Plastite Screw	2	
964237	Set Screw Socket M5X30 Zinc	2	
964238	Plastite Screw M6x45 Pan HD PL Zinc	2	
964432	Set Screw Socket M5X30 Zinc	1	
964433	Set Screw Socket M5X20 Zinc	1	
964434	Set Screw Socket M5X25 Zinc	1	
964436	Flat HD PHL Screw M2x8 Zinc	8	
980043	Washer Flat M12	2	
980502	M5 x 15OD Flat Washer Zinc	12	
980685	M5 Washer Flat Zinc	8	
980687	Special Washer	4	
980703	M2 Flat Washer Zinc	8	
980705	Spring Lock Washer M2 Zinc	8	



Electrical Schematic

Drawing 9

Z26BA Electrical Schematic

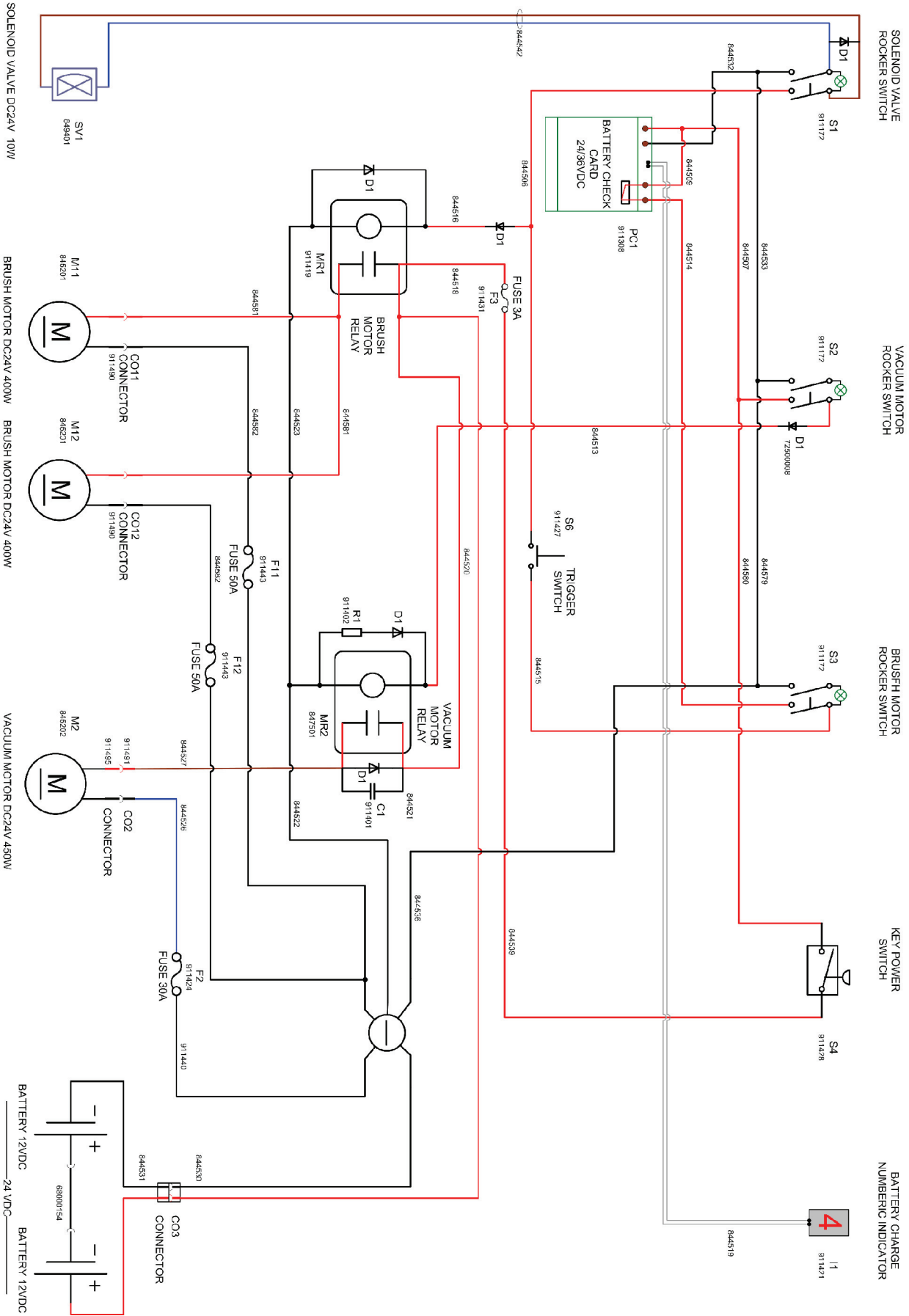



PACIFIC

Drawing 9			
PART NUMBER	DESCRIPTION & SPECIFICATION	QTY	NOTE
844506	Wire Harness	1	
844507	Wire Harness	1	
844509	Wire Harness	1	
844513	Wire Harness	1	
844514	Wire Harness	1	
844515	Wire Harness	1	
844516	Wire Harness	1	
844518	Wire Harness	1	
844519	Wire Harness	1	
844520	Wire Harness	1	
844521	Wire Harness	1	
844522	Wire Harness	1	
844523	Wire Harness	1	
844526	Wire Harness	1	
844527	Wire Harness	1	
844530	911441 2 Cables black-red and connector 50A	1	
844531	911442 2 Cables black-red and connector 50A	1	
844532	Wire Harness	1	
844533	Wire Harness	1	
844536	Wire Harness	1	
844539	Wire Harness	1	
844542	Wire Harness	1	
844579	Wire Harness	1	
844580	Wire Harness	1	
844581	Wire Harness	1	
844582	Wire Harness	1	
845201	Brush Motor	2	
845202	24VDC Vacuum Motor - SIX	1	
847501	Traction & Vacuum Motor Relay	1	
849401	Solenoid Valve	1	
887550	Traction & Vacuum Motor Relay	1	
911172	Rocker Switch Green	3	
911308	Battery Check Card	1	
911401	Capacitor 470nF-250V	1	
911402	Resistor 220 Ohm	1	
911419	Brush Motor Relay	1	
911421	Battery Charge Numeric Indicator	1	
911424	Fuse 30Amp	1	
911427	Microswitch	1	
911428	Key Switch	1	
911431	Fuse 3Amp	1	
911440	Jumper Wire	1	
911443	Fuse 50Amp	2	
911490	Butt Connector 6.0mm Yellow	4	
911491	Spade Connector Female Ins 6.3x5.0mm Yellow	2	
911495	Spade Connector male Ins 6.3x5.0mm Yellow	2	
68000154	Cable Bridge	1	
72500008	Diode IN4007	6	



**PACIFIC
WARRANTY POLICY
PACIFIC LIMITED WARRANTY**

The **Pacific** Z26BA has been manufactured, tested and inspected in accordance with specific engineering requirements. This machine is **WARRANTED** to be free from defects in workmanship and materials for periods as follows from the date of purchase.

Ten (10) Years Parts, One (1) Year Labor – Polyethylene Components
Five (5) Years Parts, One (1) Year Labor – Main Frame
Two (2) Years Parts, One (1) Year Labor – Brush Drive Motors
One (1) Year Parts & Labor – All other components unless excluded below

Travel time for warranty repair is authorized for a period of ninety (90) days following the date of sale to the end user, with a maximum of three (3) hours per claim.

This warranty extends to the original user/purchaser and only when used, operated and maintained in accordance with **Pacific** Operating and Maintenance instructions.

This warranty does not apply to certain wear parts and accessories of the machine such as electrical cords, carbon motor brushes, floor brushes, belts, hoses, tools, squeegee blades, etc., nor does it apply to damage or failure caused by improper use, abuse or neglect. Warranty credit of return parts including motors, pumps, etc., is subject to incoming inspection of those items.

To secure repair under this warranty, the following procedure should be taken:

1. After the expiration of the ninety (90) day travel time warranty period, the customer is responsible for warranty travel payment for the inoperative machine or warranted parts must be delivered to the authorized dealer with shipping and delivery charges prepaid. If unable to locate the Dealer, you may contact **Pacific** at the address listed herein for the location of the nearest **Pacific** repair center or agent or for other instructions pertaining to your warranty difficulty.
2. Upon compliance with the above warranty procedure, all warranted repairs will be completed at no additional charge or cost to the user.
3. Only **Pacific** or its authorized dealers and agents may make no charge warranty repairs on this product. All others do so at their own risk.

This warranty limits **Pacific** liability to the repair of the product and/or warranted parts replacement and does not include incidental or consequential damages arising from the use of a **Pacific** machine whether defective or not.

BATTERY WARRANTY

In addition to the terms above, any original equipment **Pacific** battery which becomes unserviceable under normal use within a period of ninety (90) days from the date of sale to the original user will be repaired or replaced with one of equal specification at our option, F.O.B. any authorized **Pacific** sales or service branch, with no charge to user, except transportation costs. After the expiration of the above ninety (90) day period, any battery which fails under normal use will be adjusted to the original user with a new battery of equal specification on a twelve (12) month pro rata basis from the date of purchase. Adjustments will be determined using the then current list price, plus transportation costs. Warranty is rendered null and void if battery is not kept filled to the proper level with **DISTILLED WATER**.

This warranty is in lieu of all other expressed or implied warranties and is extended to the original purchaser/user.