



Electronic Service Manuals

This electronic document is provided as a service to our customers. We do not create the contents of the information contained in this document. Should you have detailed questions pertaining to the information contained in this document, you may contact Michco, or the manufacturer which provided the original information in this electronic deliverable. Michco's only part in this electronic deliverable was the electronic assembly process.

You may contact Michco through the following methods:
Phone (517) 484-9312 or (800) 331-3339 MI, OH, IN only
2011 N. High St. -- Lansing, Michigan -- 48906
Fax: (517) 484-9836
Email: CustServ@Michco.com
Web site: www.Michco.Com
Parts Web site: www.FloorMachineParts.Com

Order Parts on Line at:
www.FloorMachineParts.Com

Directly to Parts & Service:
By Email: **Shop@Michco.com**
By Fax: (517) 702-2041
By Voice: Use numbers above.

Serving the Cleaning Industry Since 1922

Notice: All copyrighted material remains property of original owners, all trademarks are property of respective owners. Manuals are subject to Manufacturer's reproduction limitations. Originals or reproductions were provided by manufacturers through a request. We make no warranty as to the correctness of information provided in this document and you assume all risk.

MPV13 VACUUM CLEANER
Instruction Manual

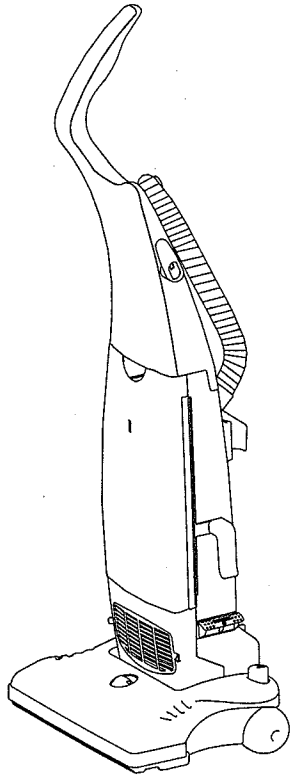

CONTENT

Important safety instructions..... 2

Technical specification..... 2

How to assemble..... 3

How to use..... 4

Maintenance..... 6

Problem solving..... 9

Exploded view..... 10

IMPORTANT SAFETY INSTRUCTIONS

When using the MPV13 vacuum cleaner, basic precautions should always be followed, including following:

READ ALL INSTRUCTIONS BEFORE USING VACUUM CLEANER

WARNING -To reduce the risk of fire, electric shock or injury:

1. Do not leave vacuum cleaner when plugged in. Unplug from outlet when not in use and before servicing.
2. Do not use outdoors or on wet surfaces.
3. Do not allow to be used as a toy. Close attention is necessary when used by or near children.
4. Use only as described in this manual. Use only manufacturer s recommended attachments.
5. Do not use with damaged cord or plug. If the appliance is not working as it should, has been dropped, damaged, left outdoors, or dropped into water, return it to a service center.
6. Do not pull or carry by cord, use cord as a handle, close a door on cord, or pull cord around sharp edges or corners. Do not run the appliance over cord. Keep cord away from heated surface.
7. Do not unplug by pulling on cord. To unplug, grasp the plug, not the cord.
8. Do not handle plug or vacuum cleaner with wet hands.
9. Do not put any object into openings. Do not use with any opening blocked; keep free of dust, lint, hair, and anything that may reduce airflow.
10. Keep hair, loose clothing, fingers, and all parts of body away from openings and moving parts.
11. Turn off all controls before unplugging.

12. Use extra care when cleaning on stairs.
13. Do not use without dust bag and/or filters in place.
14. Do not use to pick up flammable or combustible liquids, such as gasoline, or use in areas where they may be present.
15. Do not pick up anything that is burning or smoking, such as cigarettes, matches, or hot ashes.
16. Store your cleaner indoors in a cool, dry area.
17. Unplug before connecting the crevice nozzle.
18. To reduce the risk of electric shock, this vacuum cleaner has a polarized plug (one blade is wider than the other). This plug will fit in a polarized outlet only one way. If the plug does not fit fully in the outlets, reverse the plug. If it still does not fit, contact a qualified electrician to install the proper outlet. Do not change the plug in any way.

SAVE INSTRUCTIONS

TECHNICAL SPECIFICATION

Model	C37115-13	Rated voltage	120V~
Rated input	1200W	Rated frequency	60Hz
Dust container	0.20CUFT	Noise	78dB(A)
Suction Power	72 in H2O	Approvals:	UL /CUL

HOW TO ASSEMBLE

Attach handle

Caution: Do not catch cord under handle.

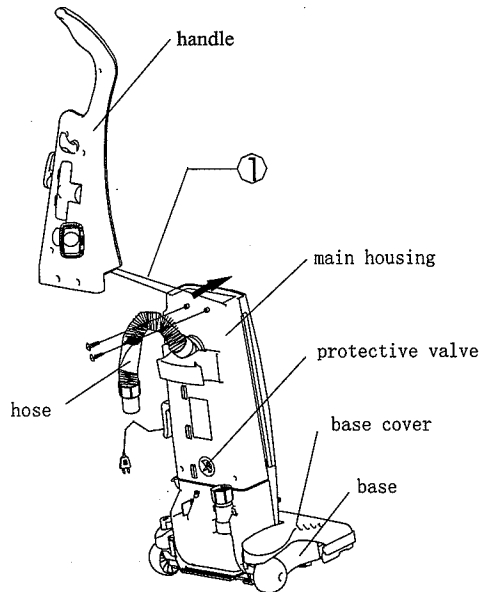

1. From rear of cleaner, align handle with groove and slide onto cleaner. If necessary, use thumb and finger pressure to slide handle into position.
2. Attach handle with two ST3.5x10 screws in the assembly packet. Use a slotted head screwdriver for tightening.

Attach hose, extension tube and crevice nozzle

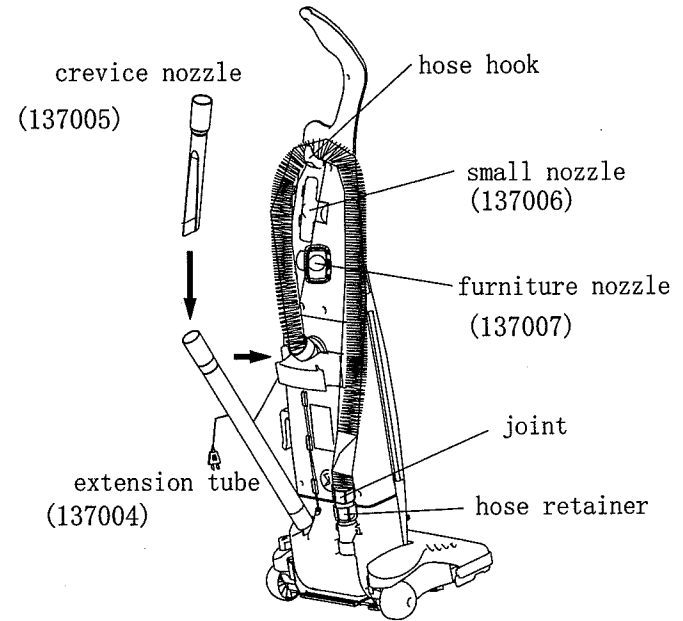

Warning: assembly the dust bag before use.

Checking dust bag

3. Remove front cover; grasp both sides of bag cover near top. Push thumbs against center of cover and pull out on sides.
4. Check to be sure the paper bag collar is secure with the hose adapter inside the paper bag collar.
5. Replace front bag cover.

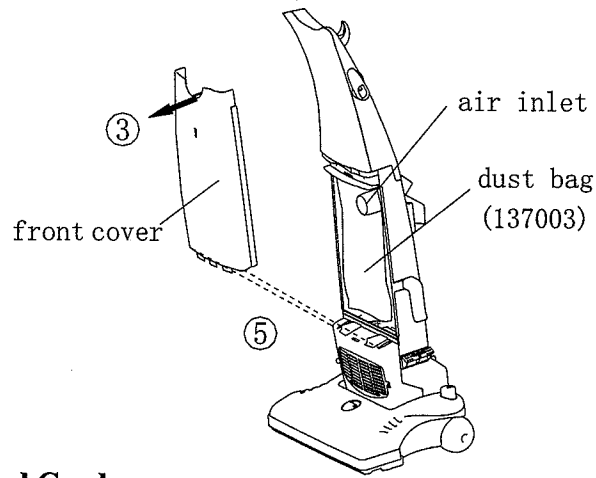

Store Electrical Cord

6. You will find your cord retainer either at the bottom of the upper cord hook or on the handle above the upper cord hook. Firmly push the electrical cord down into either cord retainer. This will place the cord out of the way the next time you vacuum.
7. Next wind the cord around the two cord hooks on the one side of cleaner. On some models the upper cord hook turns to release the cord. Turn the hook up to store the cord.
8. Secure the plug to the cord to prevent unwinding.

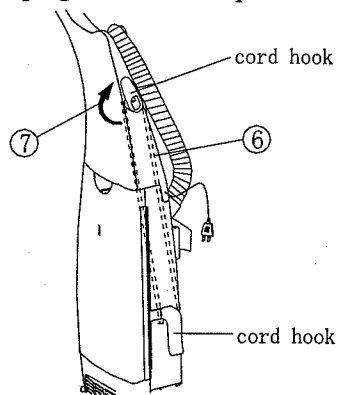

HOW TO USE

Starting the vacuum cleaner

The upright vacuum cleaner design allows use on multiple types of carpeting and on upholstery or bare floors with attachments. When using the attachment tools, place the handle in the upright position. Do not place cleaner on furniture or steps as the brush roll may cause damage.

1. Adjust cleaner height setting knob to lowest position for maximum cleaning. Adjust to a higher setting to make pushing easier. For easy adjustments, tilt the cleaner back to move the setting knob.
2. Plug electrical cord into outlet.
3. Step on handle release. Pull handle back to a comfortable position.
4. Push On or off power switch.

store or use attachments

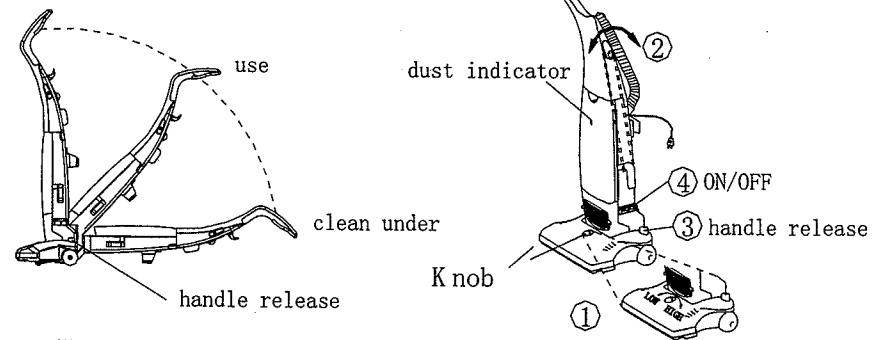

Cleaner Height Setting

Warning: Avoid injury, Keep loose clothing, hair, fingers, and all other parts of body away from any moving part (such as the revolving brush). Turn off the switch and unplug the cleaner before changing the cleaner height setting.

The front of the cleaner has an adjustment that raises or lowers the cleaner base to match the type of carpet. With the cleaner cord unplugged, set the adjustment lowest setting for maximum cleaning. If the cleaner is difficult to push, move adjustment to next highest setting until cleaner is comfortable to push. The brush roll must reach the

carpet for effective cleaning.

Make each adjustment with cleaner switch off and cord disconnected from outlet.

For ease in moving the adjustment knob, place handle in operating position and tilt cleaner back to remove weight from front wheels.

Thermal Cut-off

This cleaner has a special thermostat that protects the cleaner in case of motor overheating. If the cleaner suddenly turns off, follow this procedure:

1. Push on/off switch to off position
2. Unplug cleaner.
3. Check for source of overheating problem (i.e. full bag, clogged hose or clogged filter).
4. If a full plug, clogged hose or clogged filter is found, replace the bag, unclog the hose or replace the filters.
5. Wait at least 30 minutes before attempting to reuse the cleaner.
6. After 30 minutes cool down period, plug the cleaner in and push the rocker switch to on position. The cleaner should turn on.
7. If cleaner still does not operate, take it to the service center for repair.

Bag change indicator

When the dust bag is full of dust, the indicator on the bag cover moves into the window as the airflow through the bag decreases.. At this time, you should change the dust bag to restore maximum performance.

If a clean dust bag does not restore maximum performance, check for obstructions in the hose or airflow passage.

bag change indicator

Dust bag (137003)

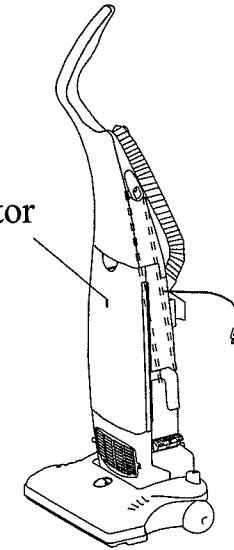

How to use accessories

Note: Do not place cleaner on furniture or steps as the brush roll may cause damage. Place cleaner on floor with the handle in storage position while using accessories.

1. Remove hose from back of cleaner.
2. Place desired accessory onto end of hose.

Crevice nozzle (137005) cleans corners, baseboards, between cushions.

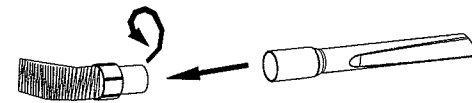

Furniture brush (137007) use brush side to dust furniture, blinds, books, lamps, shelves.

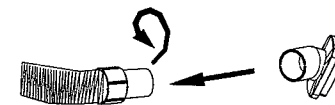

Small nozzle (137006) clean curtains, draperies, cushions, fabrics.

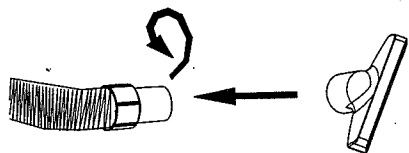

Extension tube (137004) to extend clean range.

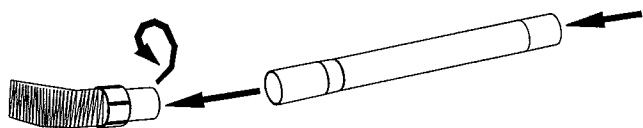

MAINTENANCE

Brush roller (137002)

The brush roll turns as it sweeps and combs the carpet nap. Remove hair and threads from brush roll so it continues brushing the carpet. To maintain the most efficient cleaning, the bristles must touch the carpet. To test the bristles length, hold a ruler against the underneath side of the cleaner. If the bristles no longer touch the ruler, replace the brush roll.

Brush roller belt (137001)

The brush roll belt turns the brush roll to agitate, sweep, and comb the carpet nap. Check the belt regularly to be sure it is in good condition. Replace the belt if it is stretches, cracks or loses tension. Cut away any hair or threads wound around the brush roll or the belt pulley because the buildup could cause the belt to rotate unevenly.

How to replace brush roller belt

Note: Turn off the switch and unplug the electrical cord before replacing belt.

Belt pulley can become hot during normal use. To prevent injury, avoid touching the motor pulley when checking the belt.

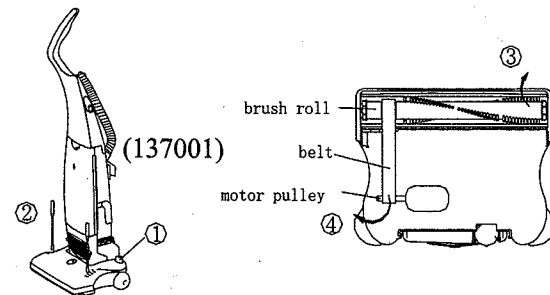

1. Lower handle to floor to change belt.
2. Loosen, but do not remove, two screws to release hood. Lift hood to remove.
3. Lift left end of brush roll.
4. Remove and discard belt.

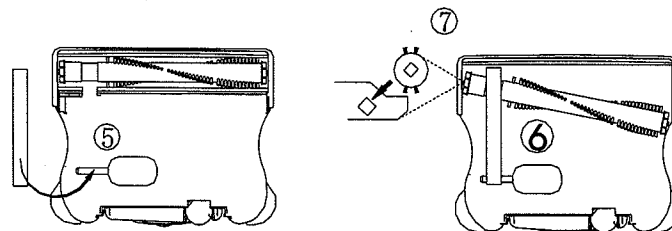

5. Place new belt around motor pulley.
6. Place belt around brush roll pulley.
7. Align right end cap with square in base. Push end cap into place.
8. Pull left side of brush roll to stretch belt. Secure left end cap into base.
9. Rotate brush roll to seat belt.
10. Replace the hood. Make sure hood front is behind furniture guard. Hood should seat onto self-locating screw tabs.
11. Tighten screws.

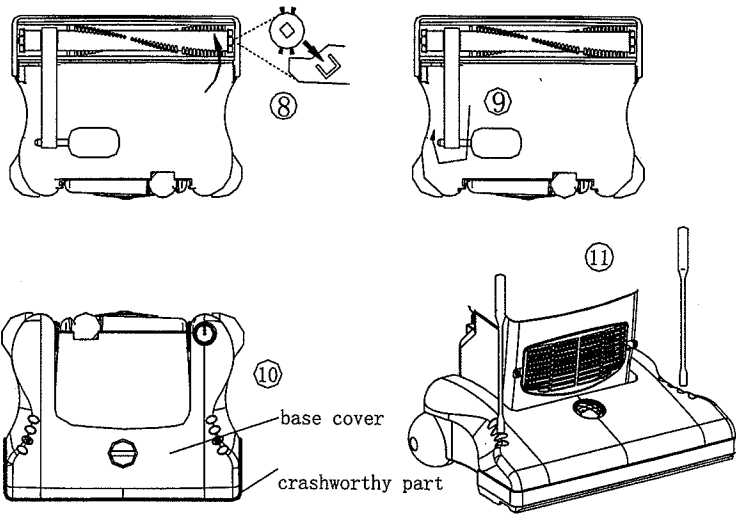

How to check and clear hose blockages

Note: Low suction or poor pick up may be due to a blockage in the vacuum cleaner. Turn off the switch and unplug the electrical cord before clearing hose.

1. Remove hose and check suction at end of hose-if little or no suction, check disposal dust bag. Change if needed. If no improvement proceed to step 2.
2. Remove the handle from the vacuum cleaner by removing the two screws and sliding the handle towards the rear.
3. Loosen another two screws, disconnect the attachment hose from the unit. Check for any obstructions that may be in the hose. Any obstructions can be removed by using a blunt instrument to clear the hose. Flexing the hose may help loosen the clog.
4. Reinstall the hose after cleaning the clog. Make sure the hose is inserted into the top of the vacuum cleaner before reattaching the handle.

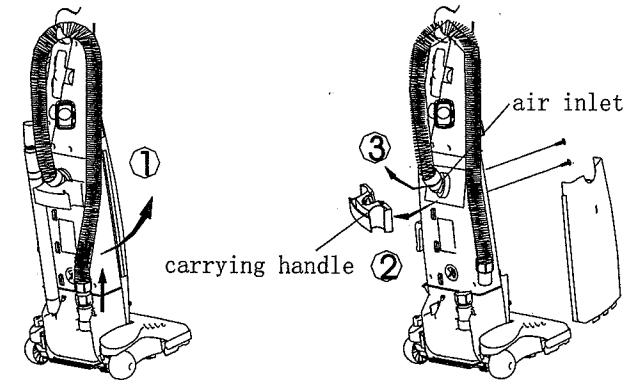

Note: If no improvement in performance on carpet, proceed to following page.

1. Remove the attachment hose from the lower hose retainer and look into the hose retainer for any obstructions. Proceed to step 2 to check for any other blockages.
2. Remove the hood by loosening the two screws located on the top of the hood and lifting upward.
3. Step on the handle release and lower the handle all way to the floor.
4. Check for blockages in the brush roll area and remove any obstructions found there. The base hose can be cleared of any blockage by using a blunt instrument.
5. After the blockage is removed, replace the hood and tighten the two hood screw. Raise the handle to the upright position and replace the hose into the lower hose retainer.

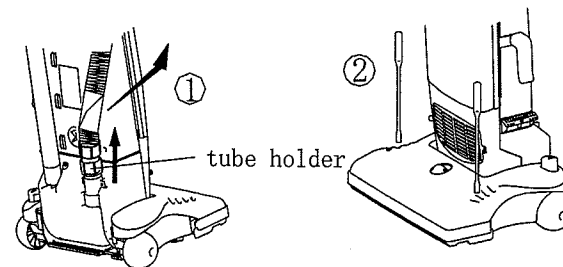

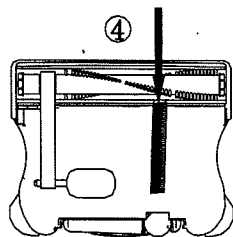
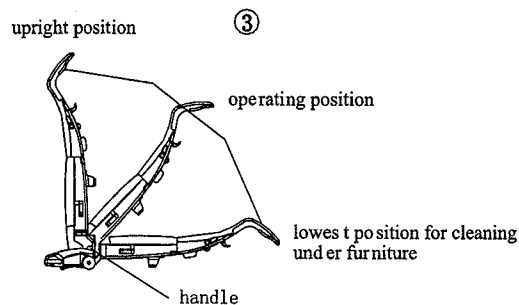

Disposal dust bag and filters

Note: Turn off the switch and unplug the electrical cord before changing dust bag.

Never operate the vacuum cleaner without the dust bag or the filter.

The disposal dust bag plays a very important role in the efficiency of a vacuum cleaner. The purpose of the paper bag is to trap dirt. As the bag traps dirt, it must also be porous to allow air to pass on through. If the paper bag becomes clogged, no air can pass through the cleaner and no cleaning can take place regardless of how powerful the unit. Change the dust bag and check the filters frequently. Some fine particles can restrict airflow very quickly and will decrease performance even before the bag appears to be full.

When vacuuming carpet fresheners or cleaners, powder, plaster dust, or similar fine substances, the bag and filters may require more frequent maintenance.

How to change dust bags

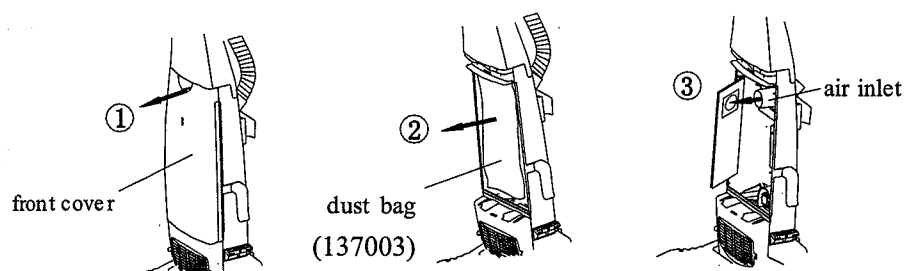

1. Remove front cover. Grasp both sides of bag cover near top. Push thumbs against center of cover and pull out on sides.

2. Grasp bag collar; pull down slightly and out to remove bag.
3. Align bag collar hole and notch with hose adapter. Push collar to rear of compartment. Check to be sure hose adapter inserts into bag collar.
4. Tuck bag into bottom and along sides.
5. Replace front cover. Make sure disposable bag does not catch under front cover.

Motor filter (137008)

Check the motor filter with each disposable dust bag change. Clean or replace as needed.

To clean motor filter

1. Remove filter from inside bag compartment.
2. Shake filter to remove excess dust. If necessary, rinse the filter under warm running water.
3. Reinstall filter when completely dry.

Inspect the micron filter periodically and change as needed. For maximum efficiency, replace the micron filter periodically.

To clean micron filter (137009)

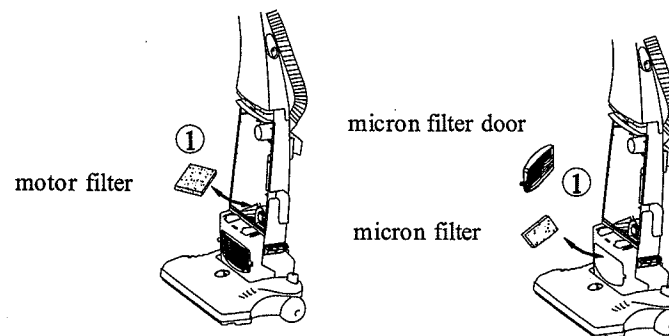

1. Open micron filter door, grasp micron filter and pull out.
2. Push new micron filter into cleaner.
3. Close micron filter door.

PROBLEM SOVING

Note: turn off the switch and unplug the electrical cord before servicing.

Problem	Cause	Solution
Motor will not start.	1. Electrical plug.	<ol style="list-style-type: none"> 1. Push plug securely into outlet. 2. Try another outlet 3. Check circuit breaker.
Motor suddenly stops.	1. Thermal cut off.	Refer to page 5.
It can't clean the carpet or floor.	<ol style="list-style-type: none"> 1. Disposable dust bag and filter; 2. Belt; 3. Belt cap; 4. Brush roll; 5. Hose. 	<ol style="list-style-type: none"> 1. Change the bag and cleaner or replace the filters. Hint: if picking up fine dust, the bag may not look full but a fine substance tends to reduce suction when it blocks the airflow through the paper bag and filters. 2. Be sure hose adapter inserts into paper bag. 3. Replace a cut, loose or out of shape belt. 4. Snap the belt cap inside the hood if it comes loose. 5. Clean hair and thread from bristles and end cap area. Replace brush roll if bristles are worn. 6. Remove any clogs from the hose that restrict the airflow. Check short hose in the base and long hose.

No suction at the end of the hose.	<ol style="list-style-type: none"> 1. Hose adapter; 2. Disposable dust bag and filter; 3. Hose. 	<ol style="list-style-type: none"> 1. Hose adapter has to seat inside the dust bag. Hint: put the hose in place before attaching the handle. The handle secures the hose. 2. Change the bag and clean or replace the filters. Hint: If picking up fine dust, the bag may not look full, but a fine substance tends to reduce suction when it blocks the airflow through the paper bag and filters. 3. Remove any clogs from the hose that restrict the airflow. Check short hose in the base and long hose.
Noise from the brush rolls area.	<ol style="list-style-type: none"> 1. Brush roll; 2. Belt. 	<ol style="list-style-type: none"> 1. Remove hood and clean debris or items from the brush roll area. 2. Replace a cut, loose or out of shape belt.
Cleaner is hard to push.	<ol style="list-style-type: none"> 1. Cleaner height setting; 2. Belt. 	<ol style="list-style-type: none"> 1. Turn adjustment knob to a higher position. Hint: Put handle in operating position. Tilt the cleaner back to raise the front wheels off floor. Then turn the knob. 2. Replace a cut or loose and out of shape belt.
Cleaner height knob will not turn.	<ol style="list-style-type: none"> 1. Cleaner height setting. 	<ol style="list-style-type: none"> 1. Hint: Put handle in operating position. Tilt the cleaner back to raise the front wheels off floor. Then turn the knob.
Warranty : 1 year parts, 90 days labor		

C37115-13 exploded view

