



Electronic Service Manuals

This electronic document is provided as a service to our customers. We do not create the contents of the information contained in this document. Should you have detailed questions pertaining to the information contained in this document, you may contact Michco, or the manufacturer which provided the original information in this electronic deliverable. Michco's only part in this electronic deliverable was the electronic assembly process.

You may contact Michco through the following methods:
Phone (517) 484-9312 or (800) 331-3339 MI, OH, IN only
2011 N. High St. -- Lansing, Michigan -- 48906
Fax: (517) 484-9836
Email: CustServ@Michco.com
Web site: www.Michco.Com
Parts Web site: www.FloorMachineParts.Com

Order Parts on Line at:
www.FloorMachineParts.Com

Directly to Parts & Service:
By Email: **Shop@Michco.com**
By Fax: (517) 702-2041
By Voice: Use numbers above.

Serving the Cleaning Industry Since 1922

Notice: All copyrighted material remains property of original owners, all trademarks are property of respective owners. Manuals are subject to Manufacturer's reproduction limitations. Originals or reproductions were provided by manufacturers through a request. We make no warranty as to the correctness of information provided in this document and you assume all risk.

SelectVac™ 11/12/12HP/16HP



OPERATOR MANUAL

**SelectVac™ MODELS 56648090(11), 56648091(12),
56648093(12HP), 56100758(12HP/OBS), 56648094(16HP)**



KENT

A

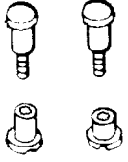

(A) 2-Part Handle Bolts

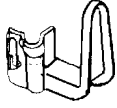

(B) Upper Cord Hook

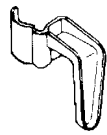

(C) Lower Cord Hook

B

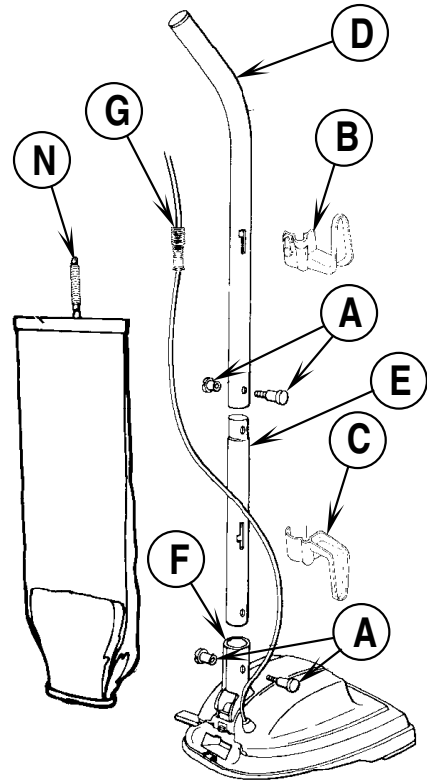

C

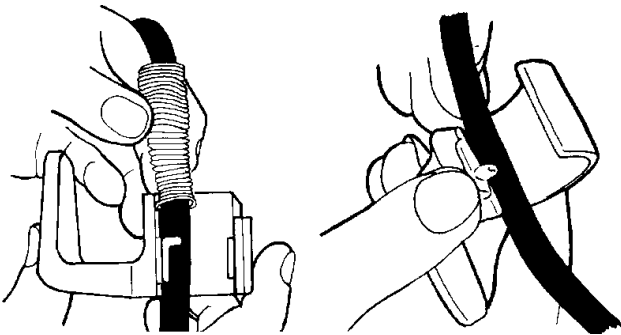

D

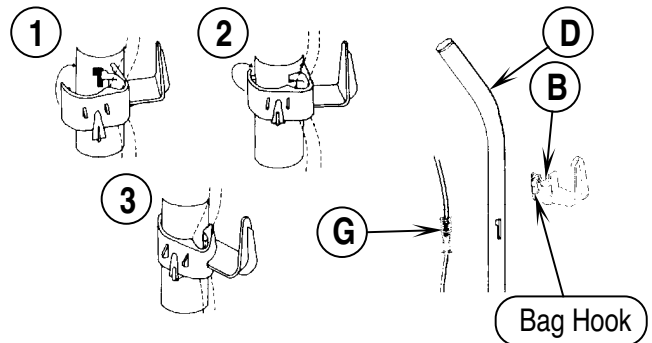

E

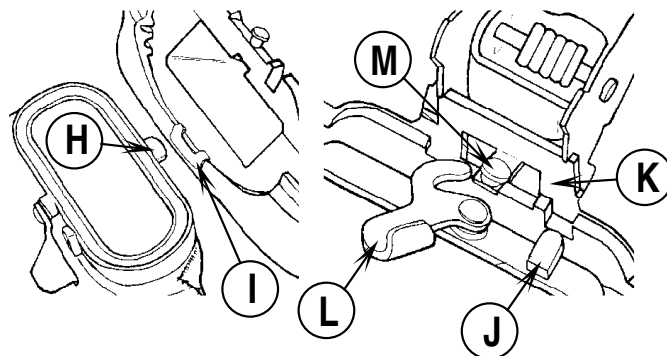

F

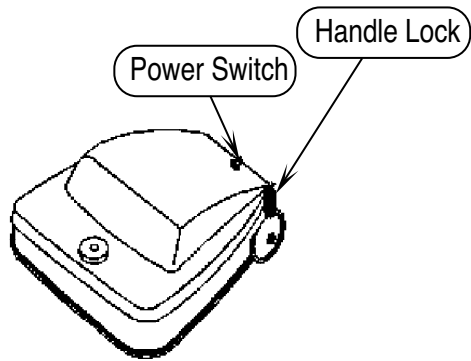

G

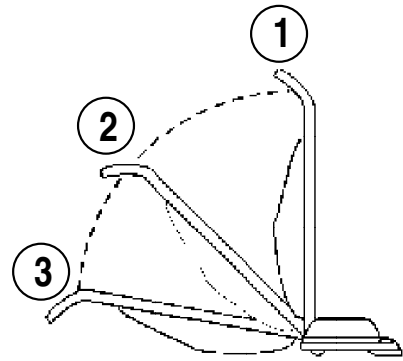

H

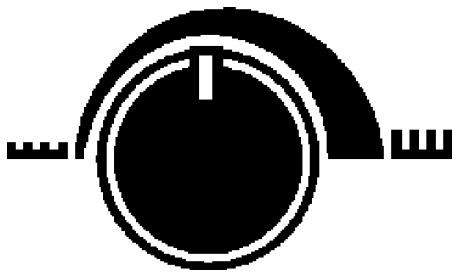

I

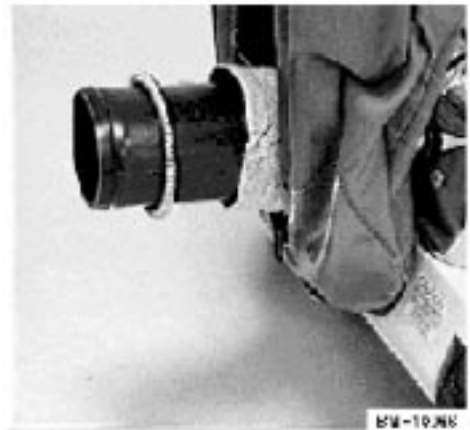

J



K

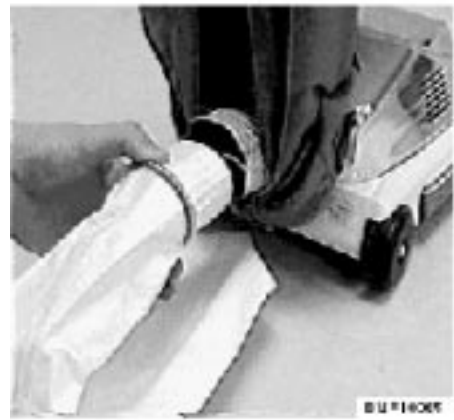

IMPORTANT SAFETY INSTRUCTIONS

When using an electrical appliance, basic precautions should always be followed, including the following:

Read all instructions before using.

This machine is for commercial use, for example in hotels, schools, hospitals, factories, shops and offices other than normal residential housekeeping purposes.

THIS APPLIANCE IS INTENDED FOR DRY USE ONLY!

DO NOT USE FOR WET FLOOR OR CARPET!

WARNING !

To reduce the risk of fire, electric shock, or injury:

Failure to follow these safety instructions could result in damage to the machine, damage to property, or bodily injury.

- * Use machine only as described in this manual. Do not use in ways it was not intended. Use only manufacturer's recommended attachments.
- * Do not leave the machine unattended when it is plugged in. Turn off all switches and unplug the electrical cord when not in use and before servicing.
- * Do not allow to be used by untrained personnel. Close attention is necessary when used near children.
- * If the machine is not working as it should, has been dropped, damaged, or left outdoors, return it to a service center before using.
- * Avoid electrical shock, do not handle the plug or machine with wet hands. To unplug the cord, grasp the plug. Do not pull on the cord.
- * Do not use extension cords or outlets with inadequate current carrying capacity. Do not use with a damaged cord or plug. Connect the machine only to a properly grounded outlet (refer to GROUNDING INSTRUCTIONS). Avoid damaging cord (closing doors on cord, pulling around sharp edges or corners, hot surfaces, or running machine over cord).
- * This machine creates suction and contains a revolving brush roll. Keep hair, loose clothing, fingers, and all other parts of the body away from openings and moving parts. Do not insert any object into any of the openings in the machine.
- * Do not pick up anything that is burning or smoking, such as cigarettes, matches, or hot ashes.
- * Do not use the machine to pick up flammable or combustible liquids such as gasoline. Do not use in areas where flammable and/or explosive vapor or dust is present to avoid the possibility of fire or explosion. Some cleaning fluids can produce such vapors.
- * This machine is not suitable for picking up health endangering dust.
- * Use extra care when cleaning on stairs.
- * Unplug electrical appliances before vacuuming them.
- * Do not use outdoors or on wet surfaces.
- * Do not use without dust bag in place.
- * Store the machine in a cool, dry area.

SAVE THESE INSTRUCTIONS

INSTRUCTIONS DE SÉCURITÉ IMPORTANTES

Toujours suivre certaines précautions élémentaires lors de l'utilisation d'un appareil électrique.

Lire toutes les instructions avant d'utiliser la machine.

Cette machine est adaptée à l'usage commercial, par exemple dans les hôtels, les écoles, les hôpitaux, les usines, les magasins et les bureaux.

CET APPAREIL NE DOIT ETRE UTILISE QU'A SEC!

NE PAS UTILISER SUR UNE SURFACE HUMIDE!

AVERTISSEMENT !

Pour réduire les risques d'incendie, de décharge électrique ou de blessures:

L'observation des instructions de sécurité risque de causer des dégâts à l'appareil et aux objets placés à proximité et d'occasionner des blessures.

- * N'utilisez l'appareil que selon les indications données dans le présent manuel. Ne l'utilisez pas à des fins pour lesquelles il n'a pas été conçu. Utilisez-le avec les seuls accessoires recommandés par le fabricant.
- * Ne laissez pas l'appareil branché sans surveillance. Fermez tous les interrupteurs et débranchez le cordon d'alimentation lorsque vous ne vous en servez pas ou avant les interventions d'entretien-réparation.
- * Ne laissez pas le personnel non formé se servir de l'appareil. Soyez particulièrement vigilant lorsque vous vous en servez en présence d'enfants.
- * Si l'appareil ne fonctionne pas normalement, si vous l'avez laissé tomber ou s'il a été endommagé ou laissé à l'extérieur, envoyez-le à un centre de réparations avant de vous en servir.
- * Pour éviter les risques d'électrocution, ne touchez pas à la prise électrique ou à l'appareil avec les mains mouillées. Débranchez le cordon en tirant sur la prise, par sur le cordon.
- * N'utilisez pas de cordons de rallonge ou de prises de capacité insuffisante. N'utilisez pas de cordons ou de prises endommagés. Branchez l'appareil uniquement à une prise correctement mise à la terre (voir les INSTRUCTIONS DE MISE À LA TERRE). Evitez d'endommager le cordon en refermant les portes, en le tirant sur des coins de meubles, en l'exposant à des objets chauffés ou en faisant passer l'appareil dessus.
- * Cet appareil produit une succion et possède une brosse tournante. N'approchez pas les vêtements lâches, les cheveux, les doigts ou toute autre partie du corps des orifices ou des pièces en mouvement. N'introduisez pas d'objets dans les orifices de l'appareil.
- * N'aspirez pas d'objets en train de brûler ou de fumer, tels que les cigarettes, allumettes ou cendres chaudes.
- * N'utilisez pas l'appareil pour aspirer des liquides inflammables ou combustibles tels que l'essence. Ne vous servez pas de l'appareil dans des endroits où il peut se trouver des vapeurs ou de la poussière explosives ou inflammables, pour éviter les risques d'incendie ou d'explosion. Certains liquides de nettoyage peuvent émettre de telles vapeurs.
- * Cette machine n'est pas destinée au ramassage de poussière dangereuse pour la santé.
- * Soyez particulièrement prudent lorsque vous passez l'aspirateur sur des escaliers.
- * Débranchez les appareils électriques avant de les nettoyer.
- * N'utilisez pas l'appareil à l'extérieur ni sur sol mouille.
- * Ne vous servez pas de l'appareil si le sac à poussière n'est pas en place.
- * Rangez l'appareil à l'intérieur, dans un endroit frais et sec.

CONSERVEZ CES INSTRUCTIONS

120VAC GROUNDING INSTRUCTIONS

This appliance must be grounded. If it should electrically malfunction, grounding provides a path of least resistance for electric current to reduce the risk of electric shock. This appliance is equipped with a cord having an equipment-grounding conductor and grounding plug. The plug must be plugged into an appropriate outlet that is properly installed and grounded in accordance with all local codes and ordinances.

⚠ DANGER!

Improper connection of the equipment-grounding conductor can result in a risk of electric shock. Check with a qualified electrician or service person if you are in doubt as to whether the outlet is properly grounded. Do not modify the plug provided with the appliance. If it will not fit the outlet, have a proper outlet installed by a qualified electrician.

This appliance is for use on a nominal 120-volt circuit, and has a grounding plug that looks like the plug illustrated in Figure 1 below. A temporary adapter illustrated in Figures 2 and 3 may be used to connect this plug to a 2-pole receptacle as shown in Figure 2 if a properly grounded outlet is not available. The temporary adapter should be used only until a properly grounded outlet (Figure 1) can be installed by a qualified electrician. The green-colored rigid ear, tab, or the like extending from the adapter must be connected to a permanent ground such as a properly grounded outlet box cover. Whenever the adapter is used, it must be held in place by a metal screw. Grounding adapters are not approved for use in Canada.

Replace the plug if the grounding pin is damaged or broken.

The Green (or Green/Yellow) wire in the cord is the grounding wire. When replacing a plug, this wire must be attached to the grounding pin only.

Extension cords connected to this machine should be 12 gauge, three-wire cords with three-prong plugs and outlets. DO NOT use extension cords more than 50 feet (15 m) long.

PLEASE NOTE: FOR NORTH AMERICA ONLY

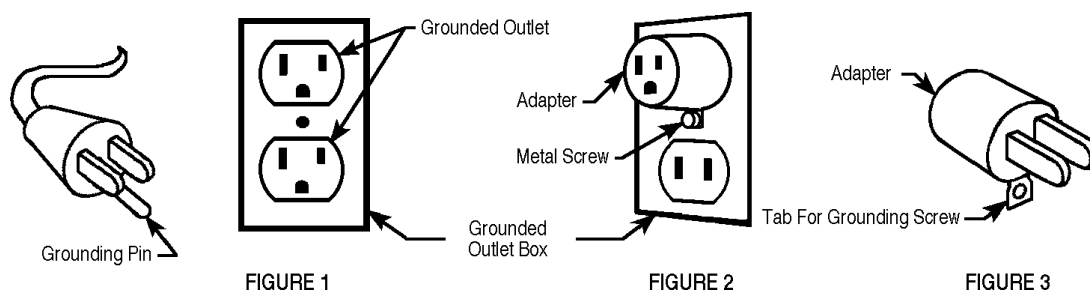

230VAC GROUNDING INSTRUCTIONS

This appliance must be grounded. If it should electrically malfunction, grounding provides a path of least resistance for electric current to reduce the risk of electric shock. This appliance is equipped with a cord having an equipment-grounding conductor and grounding plug. The plug must be plugged into an appropriate outlet that is properly installed and grounded in accordance with all local codes and ordinances.

⚠ DANGER!

Improper connection of the equipment-grounding conductor can result in a risk of electric shock. Check with a qualified electrician or service person if you are in doubt as to whether the outlet is properly grounded. Do not modify the plug provided with the appliance. If it will not fit the outlet, have a proper outlet installed by a qualified electrician.

Replace the plug if the grounding pin is damaged or broken.

The Green (or Green/Yellow) wire in the cord is the grounding wire. When replacing a plug, this wire must be attached to the grounding pin only.

Extension cords connected to this machine should be 12 gauge, three-wire cords with three-prong plugs and outlets. DO NOT use extension cords more than 50 feet (15 m) long.

PLEASE NOTE: FOR NORTH AMERICA ONLY

INSTRUCTIONS VISANT LA MISE À LA TERRE (120VAC)

Cet appareil doit être mis à la terre. En cas de défaillance ou de panne éventuelles, la mise à la terre fournit au courant un chemin de moindre résistance qui réduit le risque de choc électrique. Cet appareil est pourvu d'un cordon muni d'un conducteur de terre et d'une fiche avec broche de terre. La fiche doit être branchée dans une prise appropriée correctement installée et mise à la terre conformément aux règlements et ordonnances municipaux.

⚠ AVERTISSEMENT !

Un conducteur de terre mal raccordé peut entraîner un risque de choc électrique. Consulter un électricien ou un technicien d'entretien qualifié si vous n'êtes pas certain que la prise est correctement mise à la terre. Ne pas modifier la fiche fournie avec l'appareil - si elle ne peut être insérée dans la prise, faire installer une prise adéquate par un électricien qualifié.

Cet appareil est destiné à un circuit de 120 V et est muni d'une fiche de terre semblable à celle illustrée par le croquis 1. Un adaptateur temporaire semblable à celui illustré par le croquis 2 et C peut être utilisé pour brancher cette fiche à une prise bipolaire comme l'illustre le croquis 2 si une prise avec mise à la terre n'est pas disponible. L'adaptateur temporaire devrait être utilisé seulement jusqu'à ce qu'une prise avec mise à la terre soit installée par un électricien qualifié. L'oreille rigide ou le crochet ou autre dispositif semblable, de couleur verte, prolongeant l'adaptateur doit être raccordé à un élément correctement mis à la terre comme le couvercle d'une boîte de sortie mise à la terre. L'adaptateur doit être fixé par une vis métallique. **Note:** Au Canada, l'utilisation d'un adaptateur temporaire n'est pas autorisée par le Code canadien de l'électricité.

Remplacez la prise si la prise de terre est abîmée ou cassée.

Le fil Vert (ou Vert/Jaune) dans la gaine est le fil de terre. Lors du remplacement d'une prise, ce fil doit être raccordé à la prise de terre uniquement.

Les ralonges connectées à cette machine doivent avoir 12 mesures, trois ganses de fil ayant trois fiches masculines féminines tree-prong plugs and outlets. N'UTILISEZ PAS de ralonge de plus de 15 m (50 pieds) de long.

VEUILLEZ NOTER: CES INSTRUCTIONS CONCERNENT UNIQUEMENT L'AMÉRIQUE DU NORD

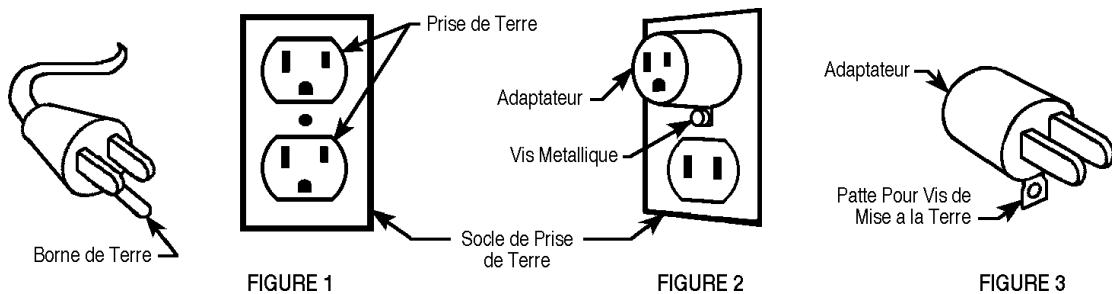

INSTRUCTIONS VISANT LA MISE À LA TERRE (230VAC)

Cet appareil doit être mis à la terre. En cas de défaillance ou de panne éventuelles, la mise à la terre fournit au courant un chemin de moindre résistance qui réduit le risque de choc électrique. Cet appareil est pourvu d'un cordon muni d'un conducteur de terre et d'une fiche avec broche de terre. La fiche doit être branchée dans une prise appropriée correctement installée et mise à la terre conformément aux règlements et ordonnances municipaux.

⚠ AVERTISSEMENT !

Un conducteur de terre mal raccordé peut entraîner un risque de choc électrique. Consulter un électricien ou un technicien d'entretien qualifié si vous n'êtes pas certain que la prise est correctement mise à la terre. Ne pas modifier la fiche fournie avec l'appareil - si elle ne peut être insérée dans la prise, faire installer une prise adéquate par un électricien qualifié.

Remplacez la prise si la prise de terre est abîmée ou cassée.

Le fil Vert (ou Vert/Jaune) dans la gaine est le fil de terre. Lors du remplacement d'une prise, ce fil doit être raccordé à la prise de terre uniquement.

Les ralonges connectées à cette machine doivent avoir 12 mesures, trois ganses de fil ayant trois fiches masculines féminines tree-prong plugs and outlets. N'UTILISEZ PAS de ralonge de plus de 15 m (50 pieds) de long.

VEUILLEZ NOTER: CES INSTRUCTIONS CONCERNENT UNIQUEMENT L'AMÉRIQUE DU NORD

INTRODUCTION

This manual will help you get the most from your **Kent SelectVac™**. Read it thoroughly before operating the machine.

This product is intended for commercial use only.

PARTS AND SERVICE

Repairs, when required, should be performed by your Authorized Kent Service Center, who employs factory trained service personnel, and maintains an inventory of Kent original replacement parts and accessories.

Call the KENT DEALER named below for repair parts or service. Please specify the Model and Serial Number when discussing your machine.

(Dealer, affix service sticker here.)

NAME PLATE

The Model Number and Serial Number of your machine are shown on the Nameplate on the bottom of the machine. This information is needed when ordering repair parts for the machine. Use the space below to note the Model Number and Serial Number of your machine for future reference.

MODEL NUMBER _____

SERIAL NUMBER _____

UNCRATE THE MACHINE

When the machine is delivered, carefully inspect the shipping carton and the machine for damage. If damage is evident, save the shipping carton so that it can be inspected. Contact the Kent Customer Service Department immediately to file a freight damage claim.

MACHINE ASSEMBLY

CAUTION!

Fully assemble the cleaner before using.

A - ASSEMBLY PACKET

The packet contains two 2-part bolts and two cord hooks. An extra drive belt is also included.

B – ATTACH LOWER / UPPER HANDLE

Slip the upper handle (D) and the lower handle (E) together so the handle bolt holes align and the slots in the handle are positioned as shown in Figure 4. Insert a 2-part bolt (A) in the center of the handle and tighten. Hold the assembled handle (D/E) so it curves away from the cleaner. Then push the handle into the handle socket (F) at the rear of the cleaner. Align the holes, insert the other 2-part bolt (A), and tighten.

C / D – CORD HOOKS

UPPER CORD HOOK: Pull the spring (G) on the cord upward toward the top of the handle. Insert the lower half of the spring (G) into the upper cord hook (B).

Make sure slots in handle are positioned properly (Figure B). Place inner tab into slot as shown in (1) and press hook around handle (2), snapping opposite inner tab into place (3) (Figure D).

LOWER CORD HOOK: Insert the power cord into the lower cord hook (C) (Figure C). Snap the hook into the lower handle. Pull the cord up to tighten but leave enough slack near the base so the cord is not strained when the handle is lowered. Wrap the cord around the two cord hooks. Fasten the plug to the cord to prevent unwinding.

E - HOW TO INSTALL THE BAG

Insert the bag adapter clip (H) on the bottom of the bag collar into the bag adapter retainer (I) below the air outlet. Push the bag collar up and forward so the locator lug (J) to the right of the cam latch (L) slides into the slot (K), then turn the cam latch to lock the bag onto the shoulder rivet (M). To support the bag, loop the spring (N) from the top of the bag onto the bag support, located to the back of the upper cord hook (B) (Figure B).

OPERATION

F - POWER SWITCH

The power switch is located at the rear of machine, to the left of the handle base. Simply step on it to turn the machine on or off.

G - HANDLE ADJUSTMENT

The handle lock is located at the left rear side of the machine. Simply step on it to release and move the handle to one of the three positions.

H - HEIGHT ADJUSTMENT

This machine has a 6-position adjustment knob. To select the proper setting, move the knob to the highest setting. Turn down one setting at a time until the machine's sound changes to a smooth buzzing or vibrating tone. This is the sound of the beater bars grooming the pile.
NOTE: Raise the front of the machine to ease changing the settings.

DUAL PURPOSE BAG

CAUTION!

Never wash or dry-clean cloth bag.

This machine comes with a cloth bag that can be used with or without disposable paper bags. Before first use, decide which way the machine is to be used.

NOTE: Once the cloth bag is used without a paper bag, do not use it with a paper bag at any time.

I - CLOTH BAG USAGE

Unzip the cloth bag and pull the bag throat out of the bag's top fill sleeve. Remove coil spring, and replace bag throat back into sleeve.

NOTE: Failure to remove spring will result in premature bag wear and leakage.

J / K - INSTALLING A DISPOSABLE PAPER BAG

Unzip the cloth bag and pull the bag throat out of the bag's top fill sleeve and move coil spring down on throat. Slide a new paper bag's top fill sleeve on cloth bag's throat, wrap tightly, and move coil spring up until it stops. Zip up cloth bag.

EMPTYING CLOTH BAG

DISCONNECT POWER CORD FROM WALL OUTLET.

The cloth bag should be emptied frequently for maximum performance. Slide top of bag out of clamp, remove bottom by pulling back on lever arm on bag collar. Dump contents into a waste container. Shake vigorously several times. Reinstall bag on machine.

NOTE: It is not necessary to remove top clamp from machine.

REPLACING PAPER BAG

DISCONNECT POWER CORD FROM WALL OUTLET.

The paper bag should be changed frequently for maximum performance. Unzip the cloth bag, and roll the coil spring off full paper bag's sleeve. Dispose of full paper bag into a proper waste container. Slide new paper bag's top fill sleeve on cloth bag's throat, wrap tightly, and move coil spring up until it stops. Zip up cloth bag. (Refer to Figure J & K)

CLEAN UP AND STORAGE

Store the machine in a cool dry place. Wind the extension cord in a circle and hang on the cord hooks provided on the machine. Be sure not to wind the cord tighter than necessary. Avoid prolonged exposure of machine to freezing temperatures during storage or transporting.

MAINTENANCE

WARNING!

BEFORE ANY SERVICING TO AVOID POSSIBLE INJURY OR ELECTRIC SHOCK, DISCONNECT THE POWER CORD FROM THE ELECTRICAL OUTLET.

BRUSH ROLL BELT REPLACEMENT

CAUTION!

Belt and pulley become hot during normal use.

The belt should be checked regularly. Replace belt if it is stretching, cracking, or slipping.

Remove the bottom chrome plate by turning the two cam locks on each side. Remove the worn belt from the drive motor pulley. Remove the brush roll from the base, and slide off worn belt. Slip new belt around brush roll and reinstall into machine. Install belt around drive pulley with low side in groove. Be sure belt is installed correctly or brush roll will turn backwards. Replace chrome cover.

NOTE: Be sure brush roll with offset belt drive is orientated correctly, with the shorter length to the left. Arrows on brush roll end caps indicates the top of cap and shows installation direction. Cut away any hair or thread wound around the brush roll or the belt pulley because the buildup could cause the belt to rotate unevenly.

BRUSH STRIP REPLACEMENT

To replace, remove the bottom chrome plate by turning the two cam locks on each side and remove brush roll from machine. Remove nuts and end caps. Slide out worn brush strips and replace. Reassemble brush roll and reinstall in machine.

NOTE: Brush strips are different lengths. Arrows on brush roll end caps indicates the top of cap and shows installation direction.

HEADLIGHT REPLACEMENT

Pry off the headlight lens. Press bulb into socket, turn and remove. Install new bulb, and replace lens.

NOTE: Use 25 watt bulb only.

CARBON MOTOR BRUSH REPLACEMENT

Have Kent check the carbon motor brushes once a year or after 500 operating hours.

IMPORTANT !

Motor damage from failure to service the carbon brushes is not covered under warranty.

FAN SCROLL

If your machine has a clear fan scroll attached to the underside of the base, this may be removed and cleaned. Remove the chrome plate and brush roll belt from pulley. Remove the two screws on either side of the clear scroll, press the cam locks outward and lift the scroll from the base. Dirt should clear easily, though some scraping may be needed. Be sure the gasket is in place, reinstall by placing the rear end between the rear wheels and seat firmly. Reinstall belt and chrome plate.



14600 21st Avenue North
Plymouth, MN 55447-3408
www.eurocleanusa.com
Phone: 800-334-1083
Fax: 866-261-4779

1151 Byrn Mawr Avenue
Itasca, IL 60143
www.eurocleanusa.com
Phone: 800-545-4372
Fax: 888-323-3822